

Structural Engineer's Seal
Mechanical Engineer's Seal
Architect's Seal

PC - 270
REVISED
DATE: FEB 19 1999
NO. FLS 23
SS 24

MODTECH INC.
2830 BARRETT AVENUE
PERRIS, CALIF. 92572
PH (909) 943-4014
FAX (909) 940-0427

ARCHITECTURAL DETAILS
ROUTE NUMBER:
© MODTECH, INC. 1999

A6.1
DRAWN BY: RVE
DATE: 2-2-99
CHECKED BY: JAC
DATE: 2-2-99
PROJECT NO.:
MODTECH Index No.:

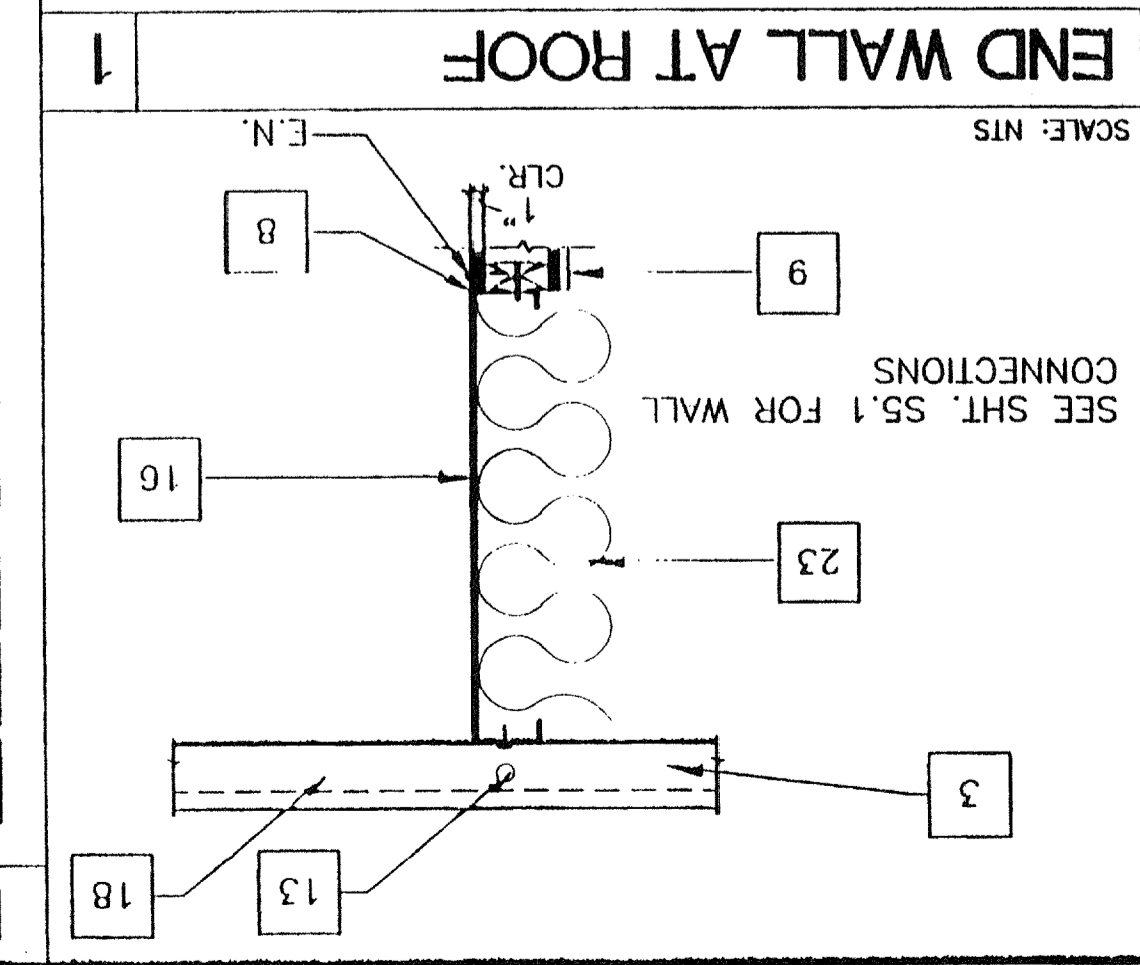
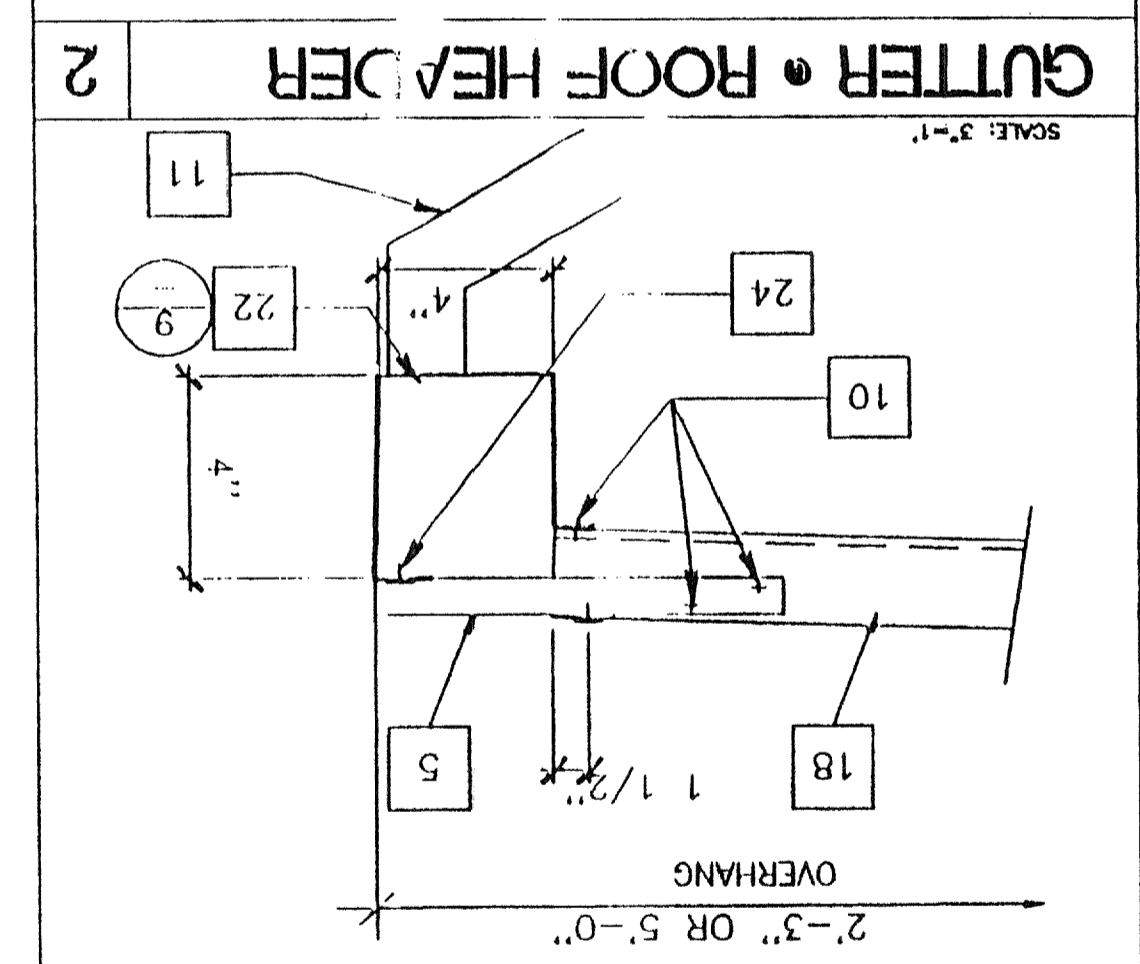
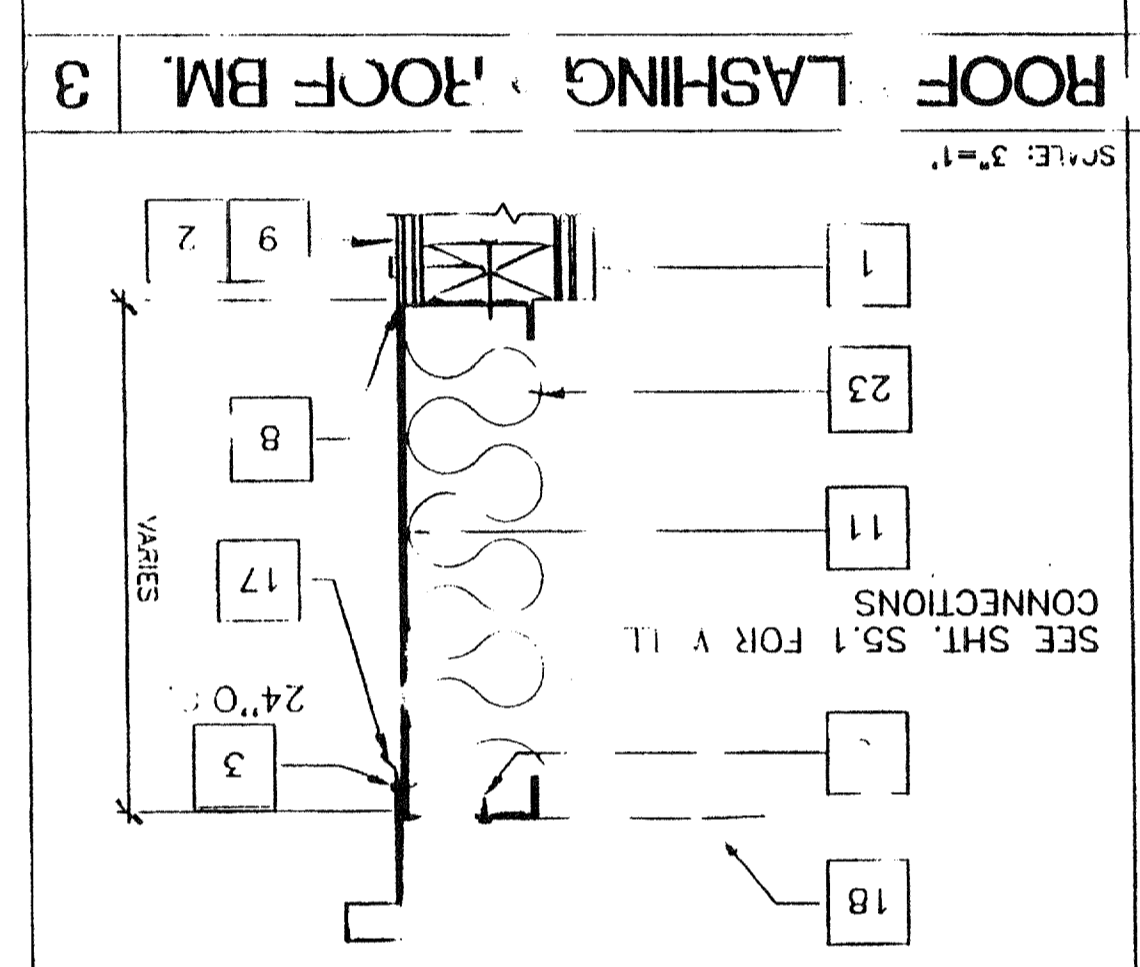
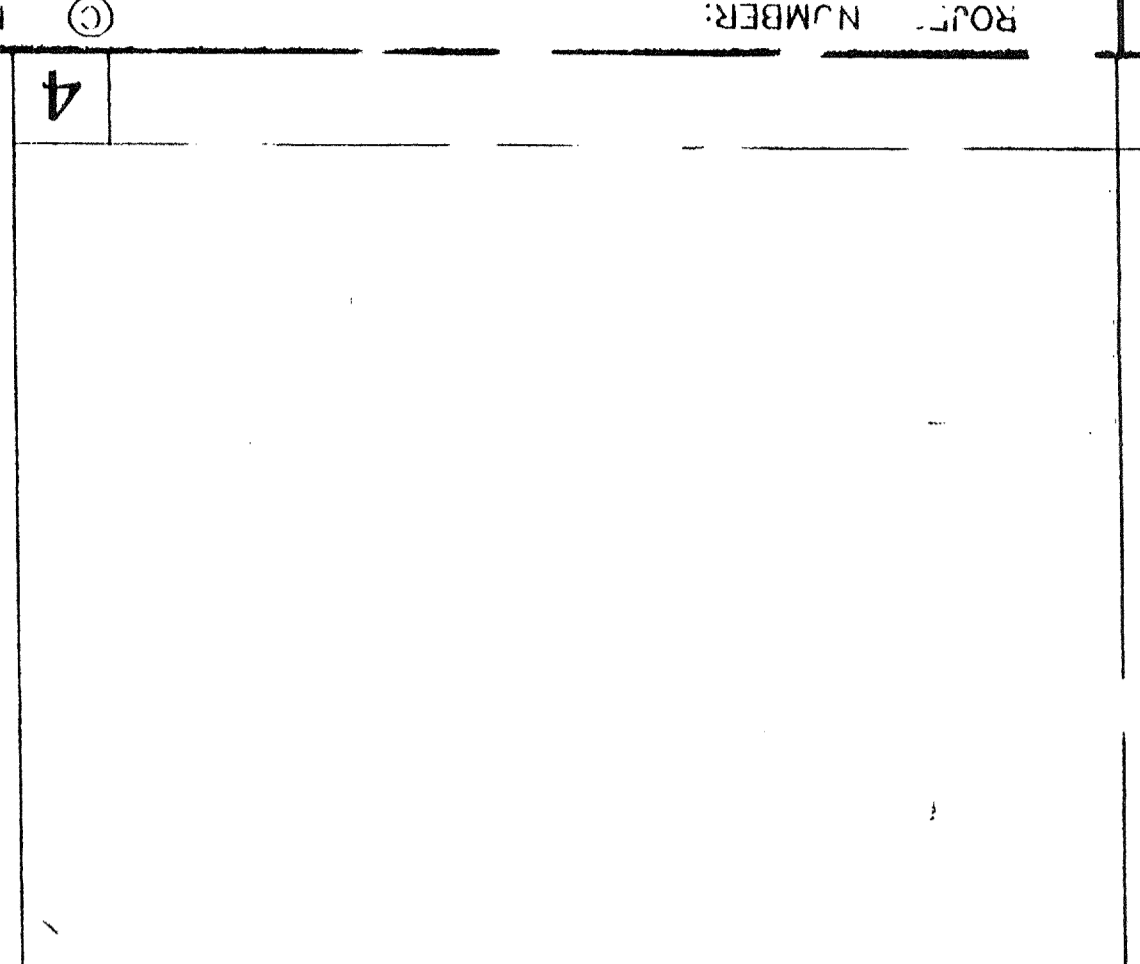
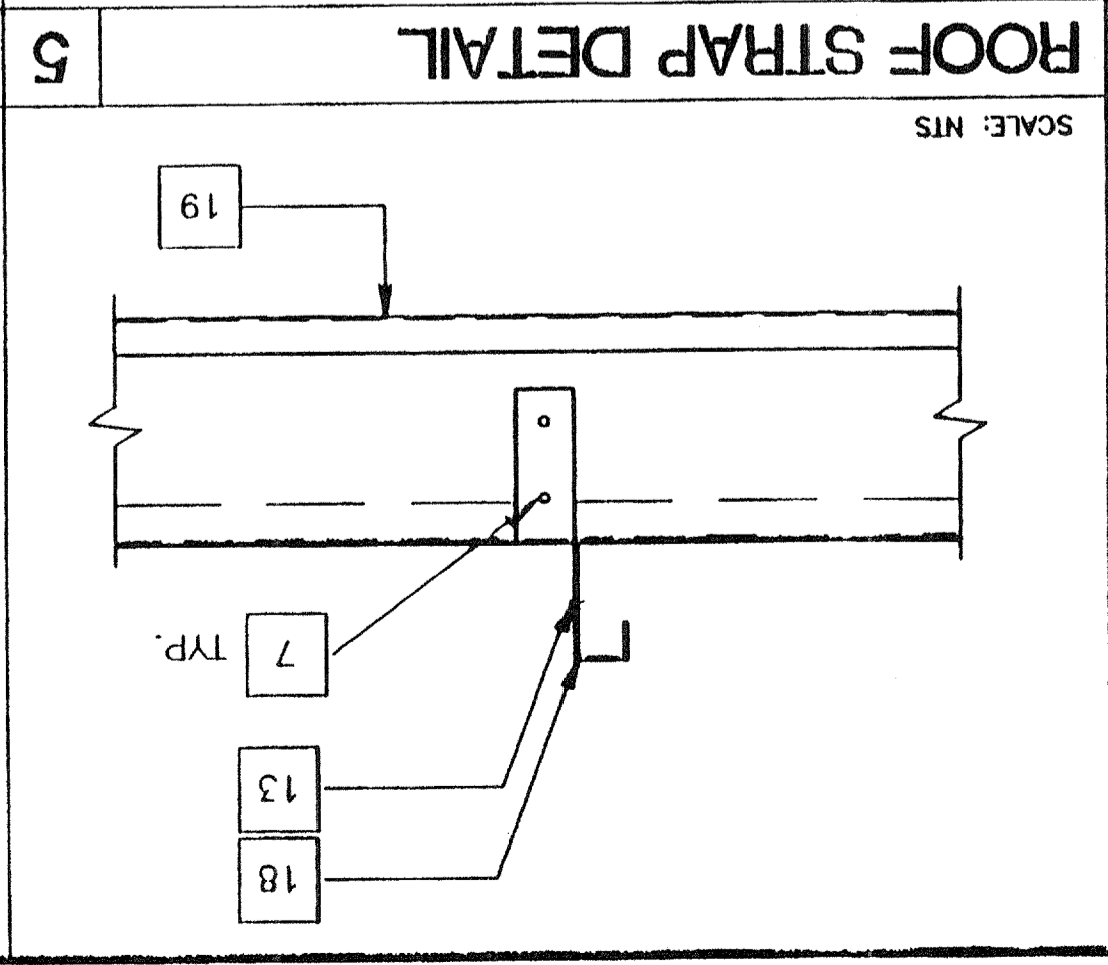
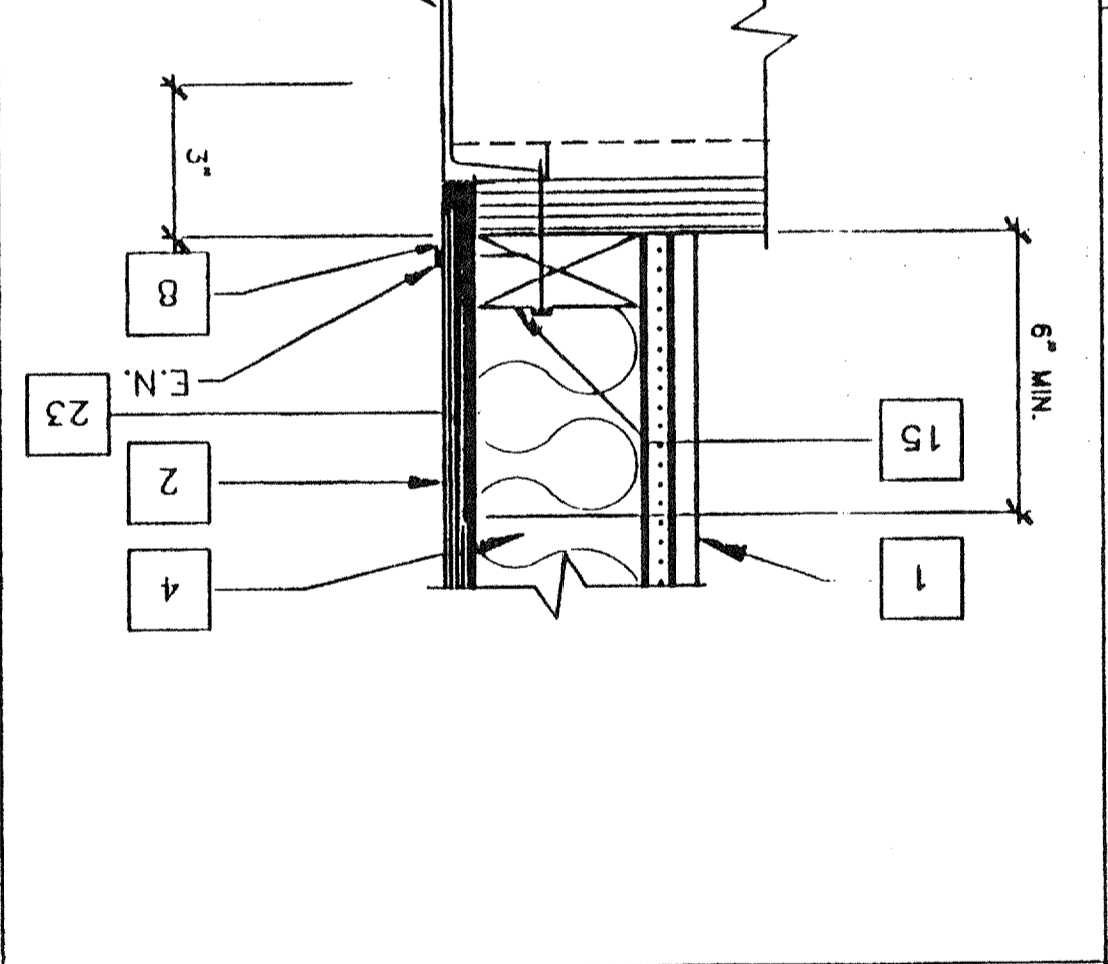
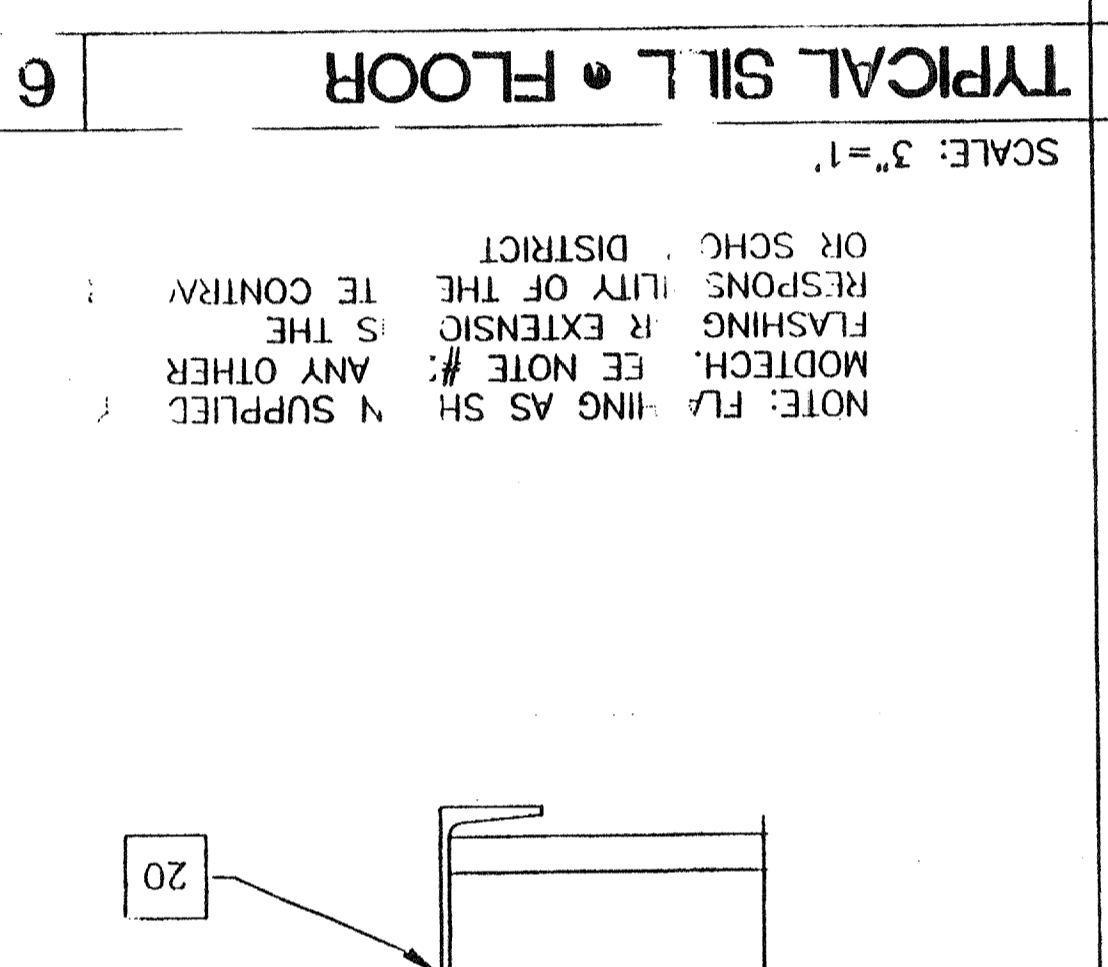
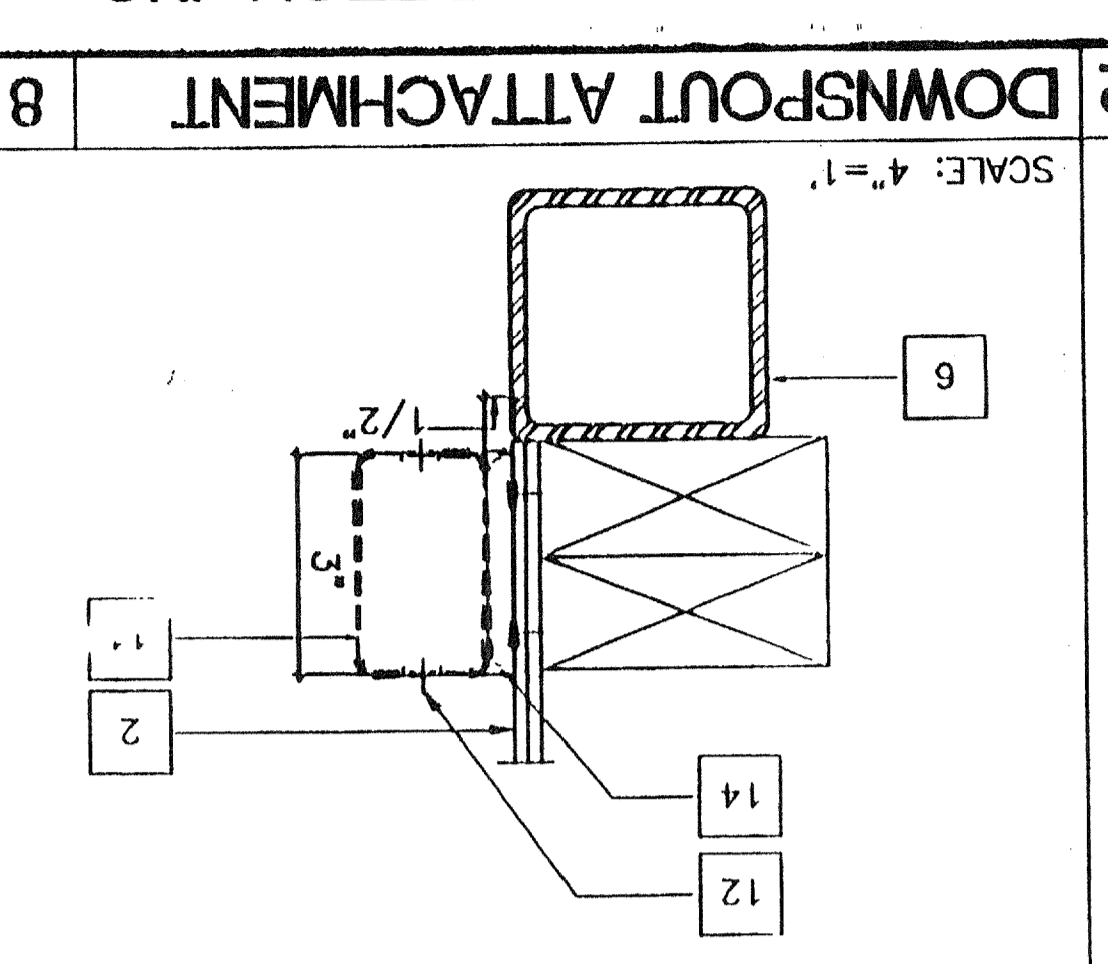
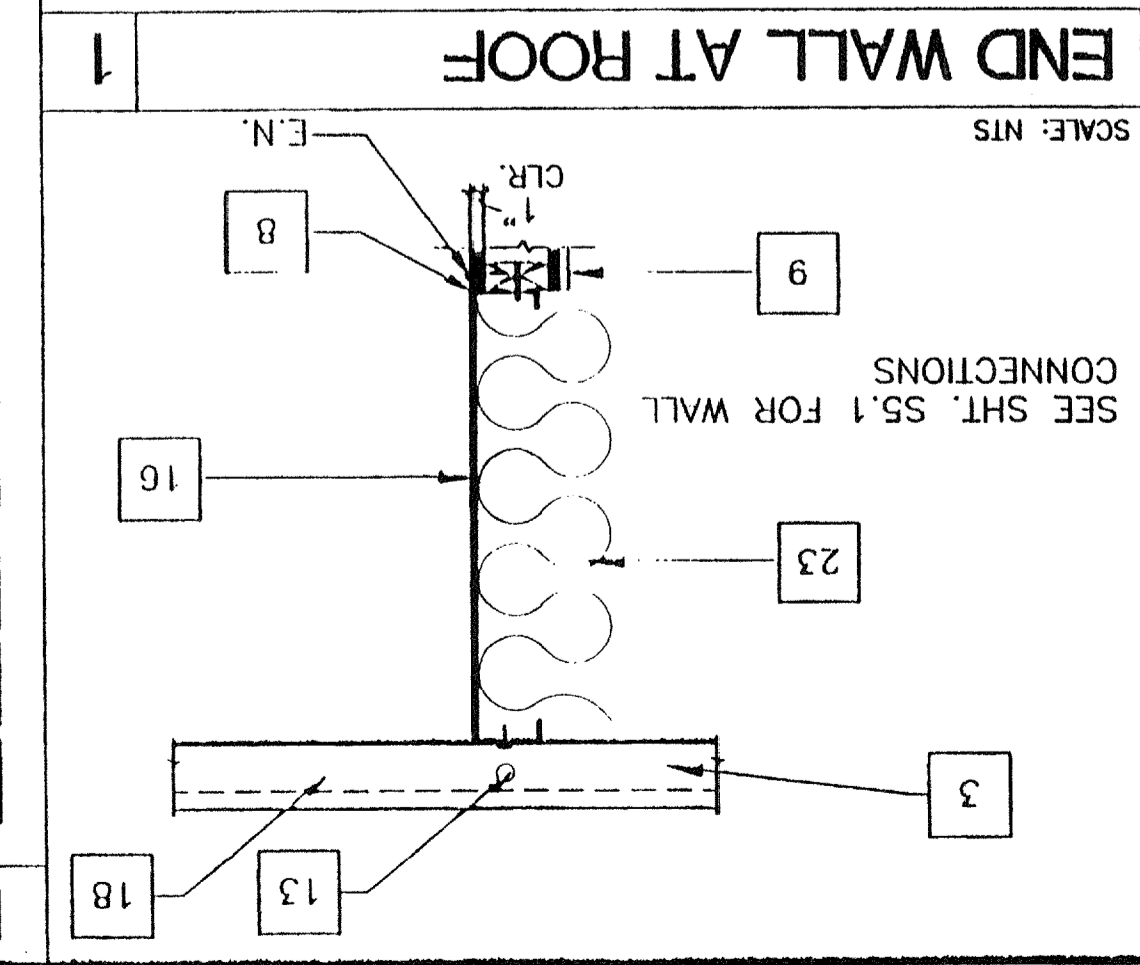
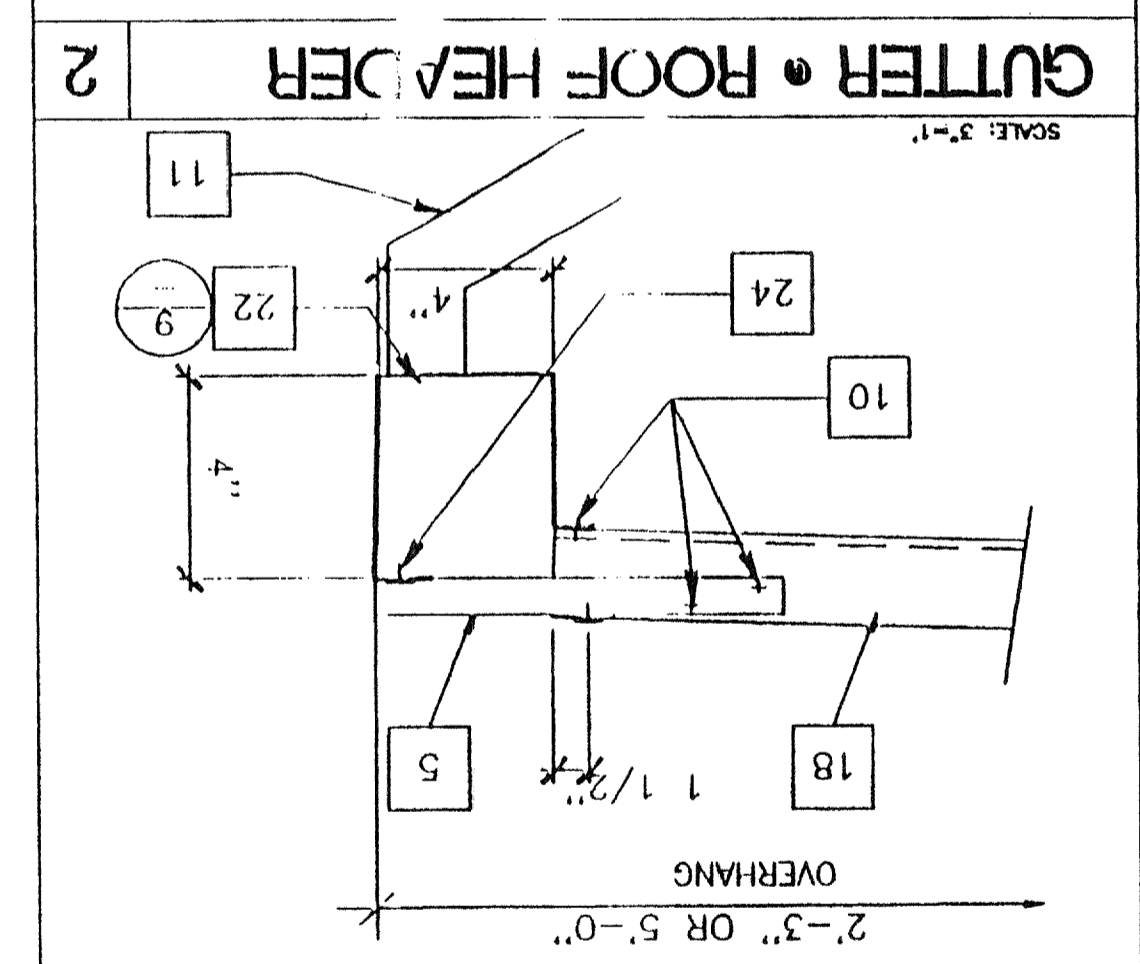
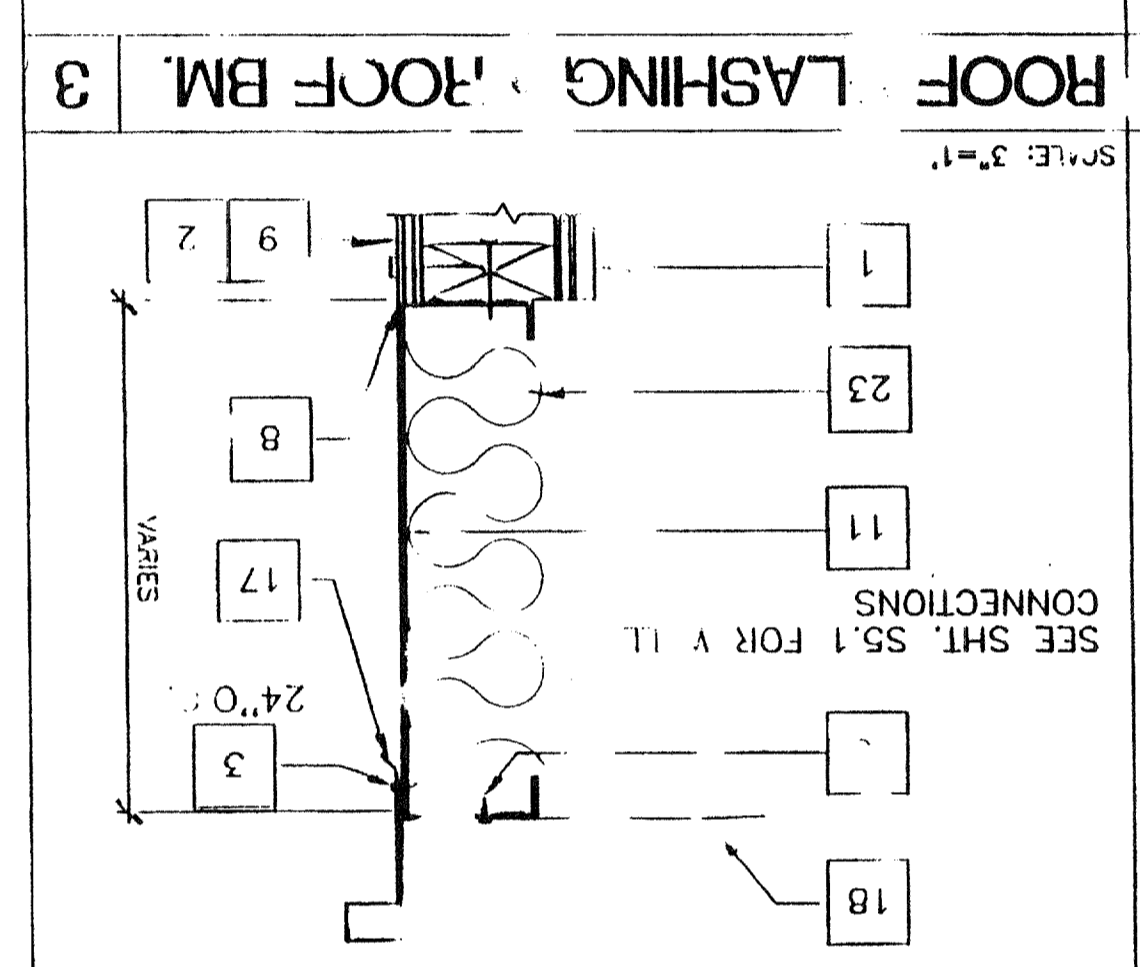
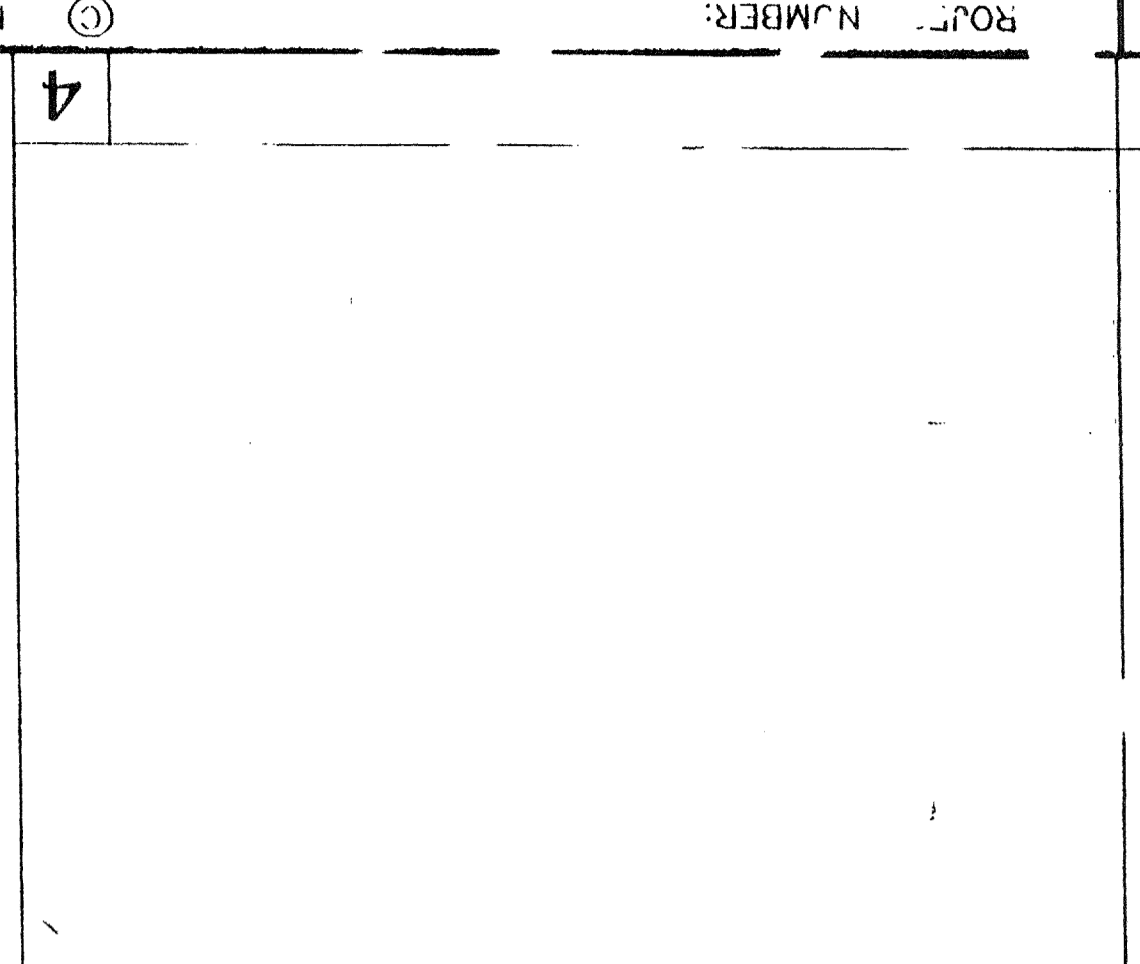
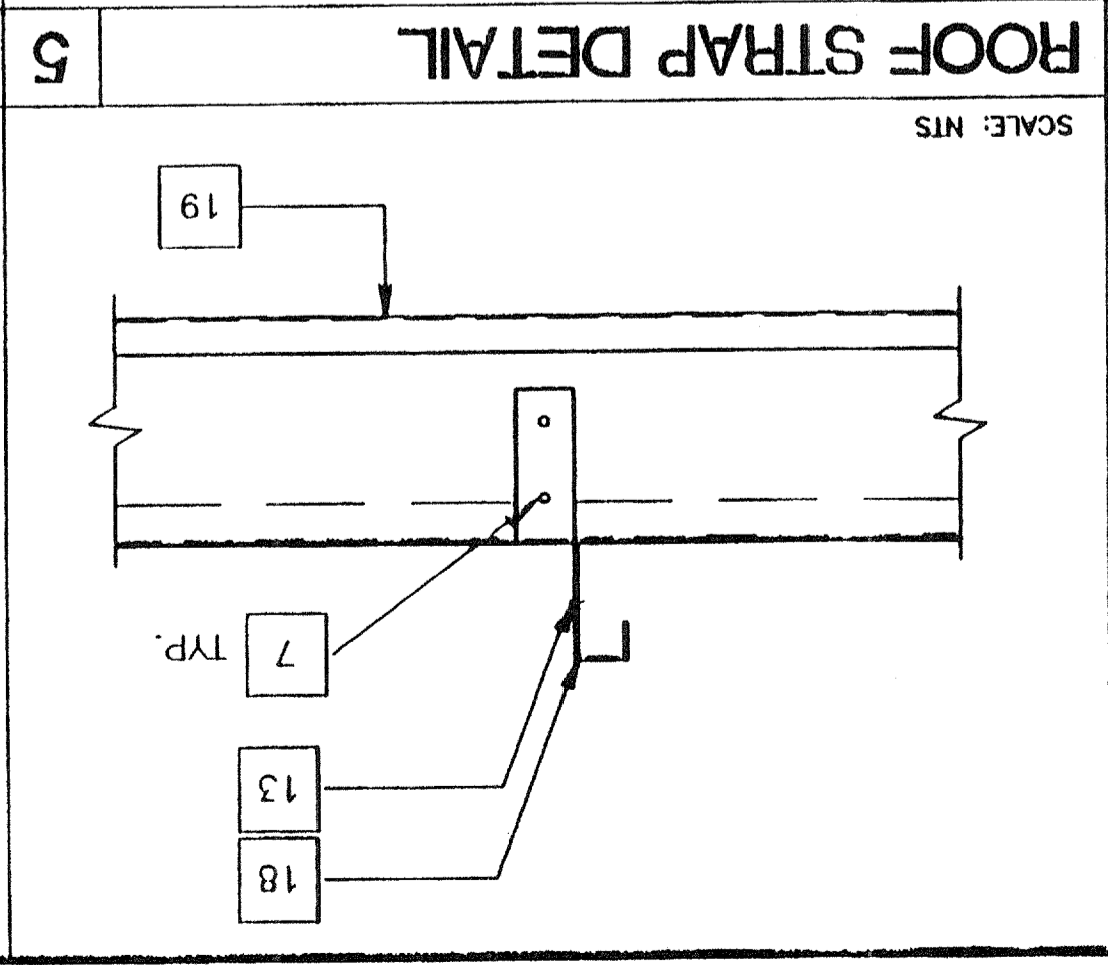
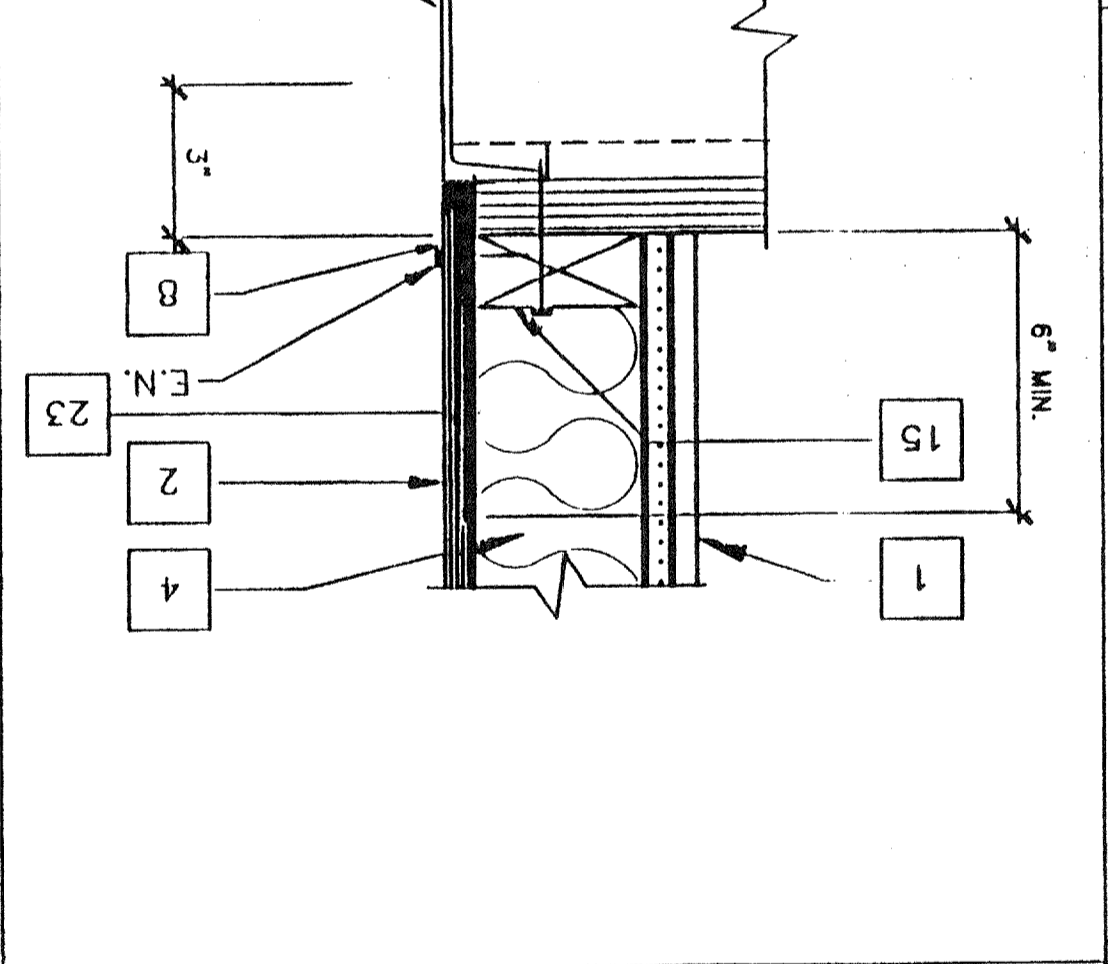
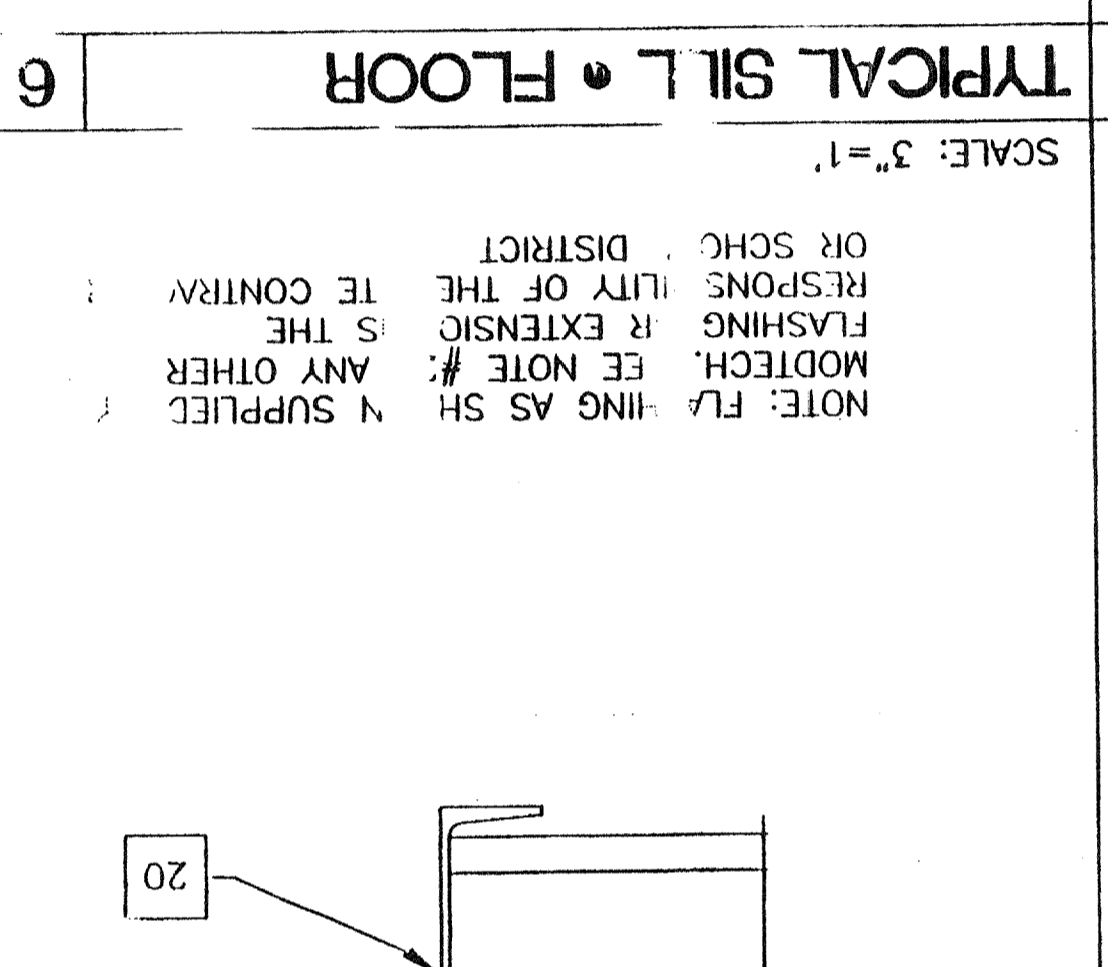
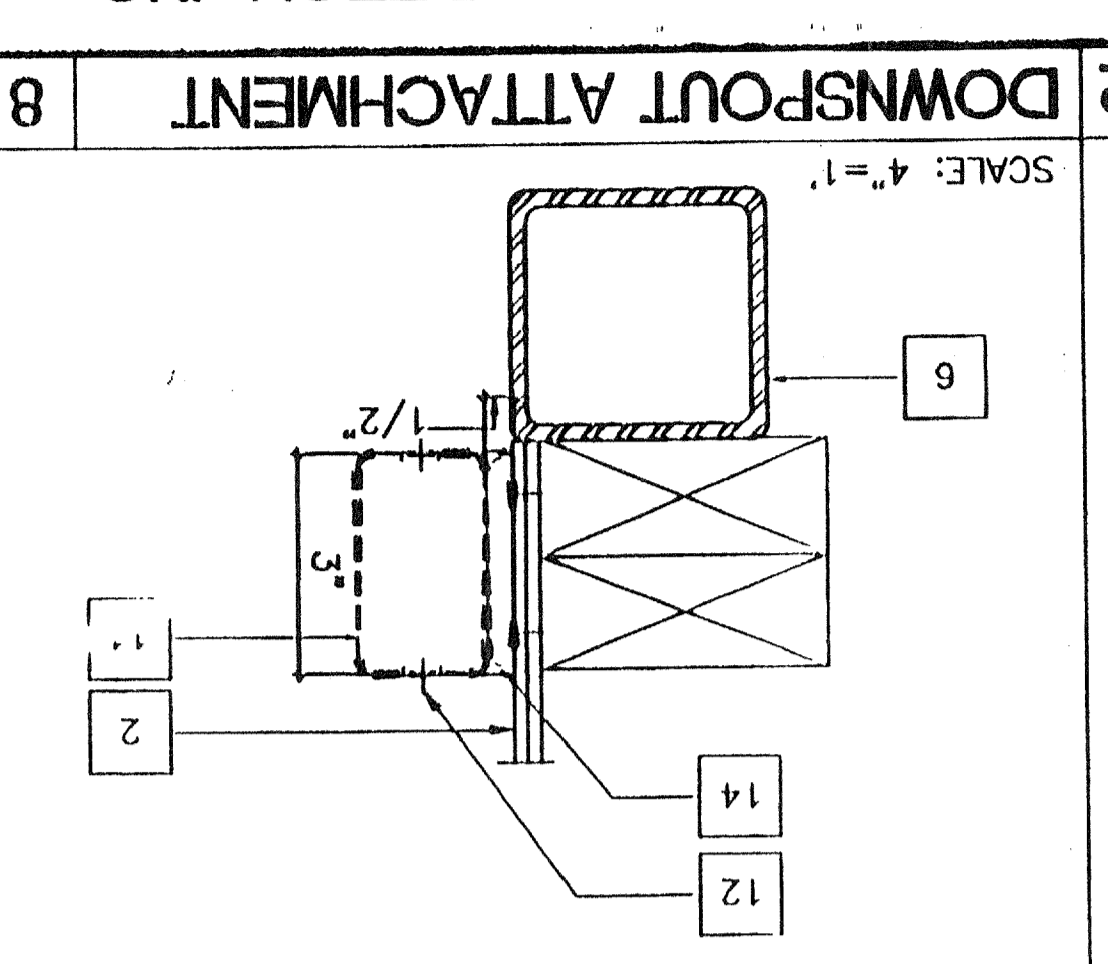
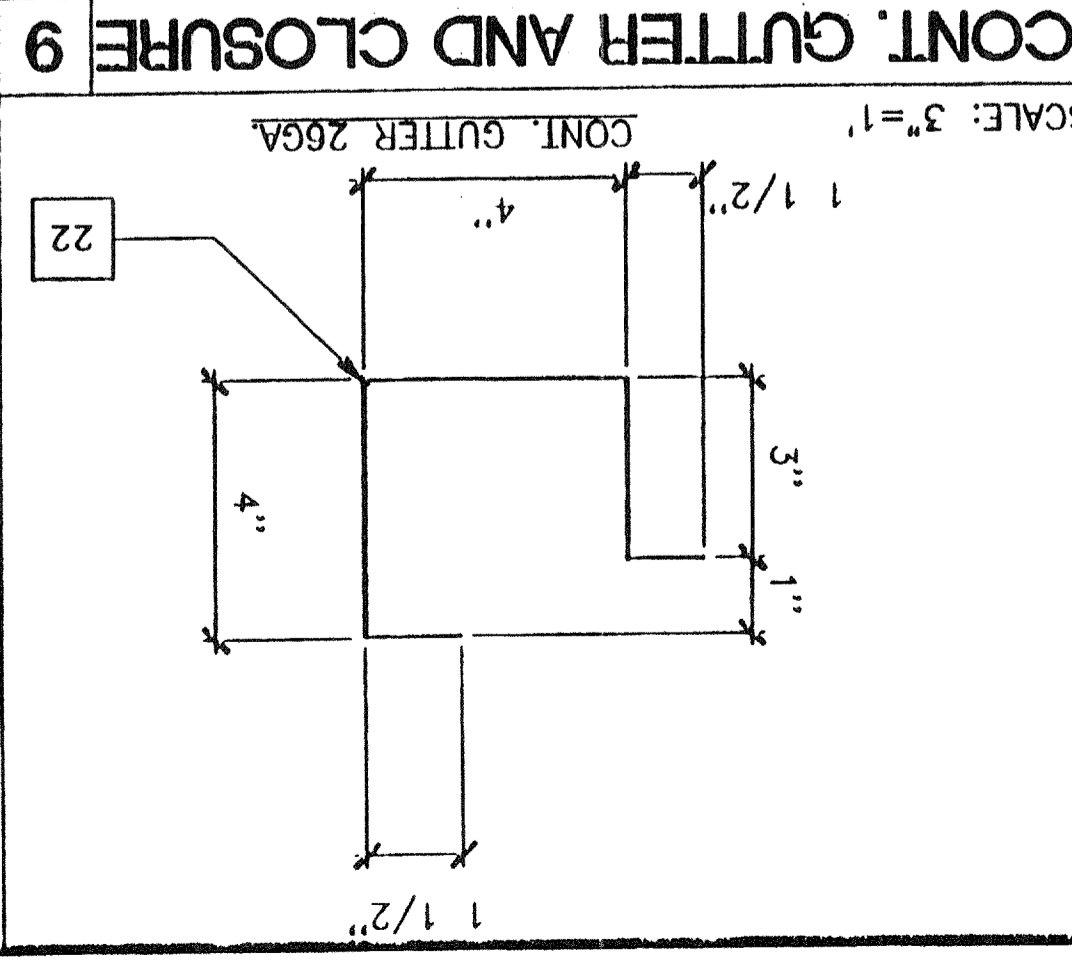
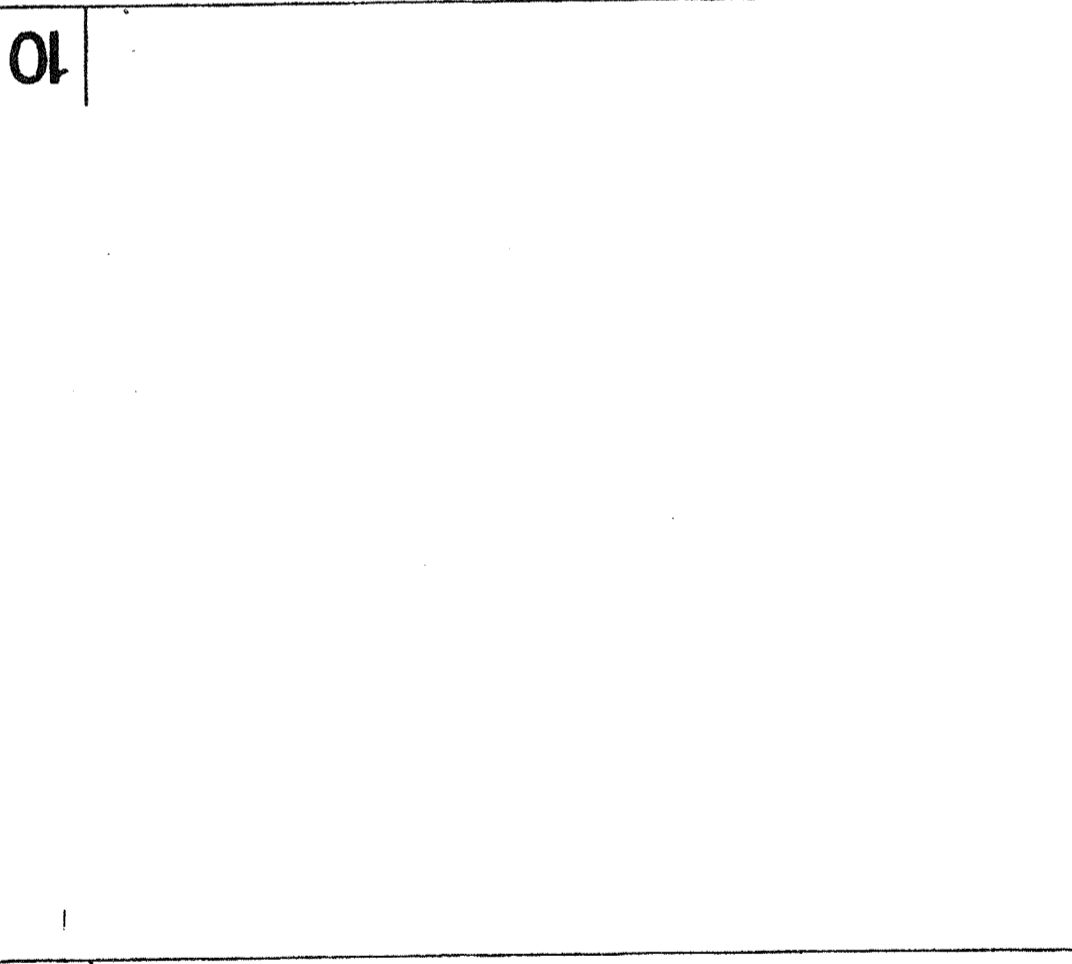
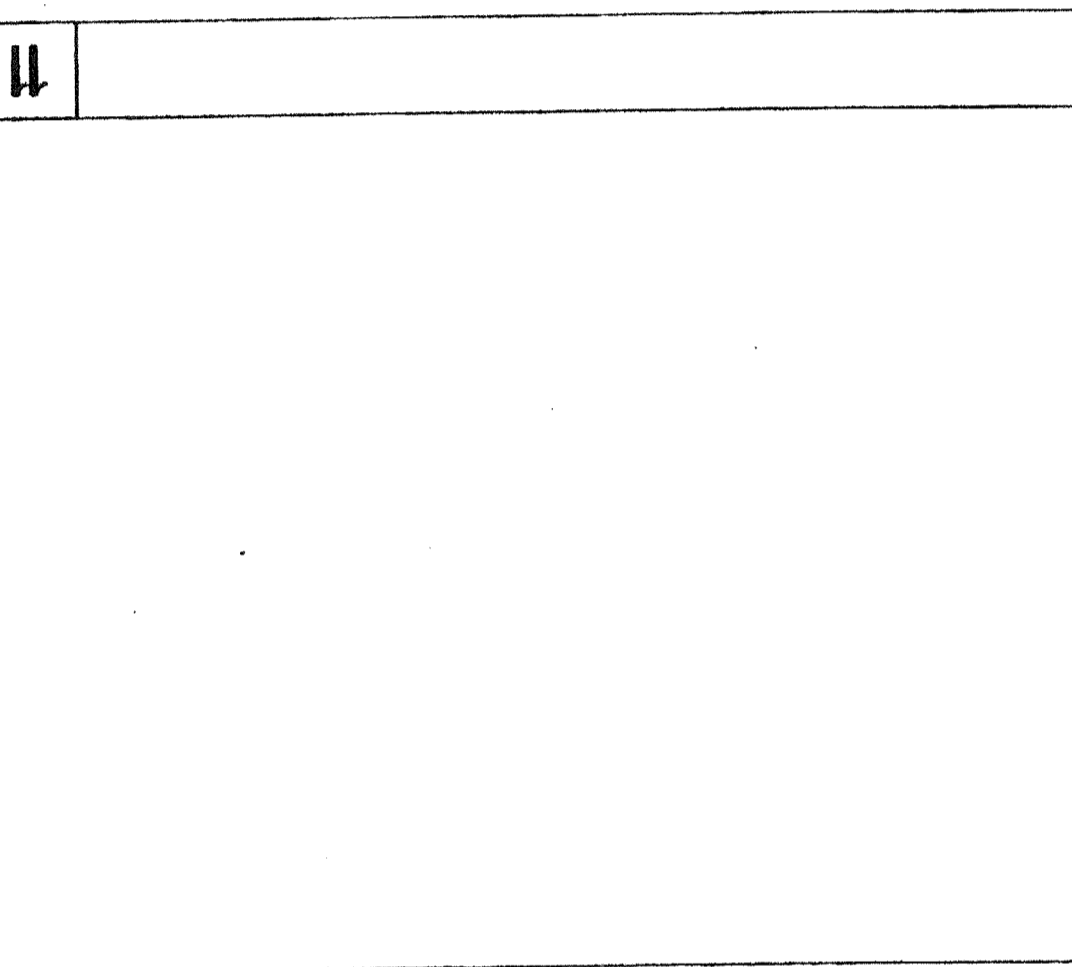
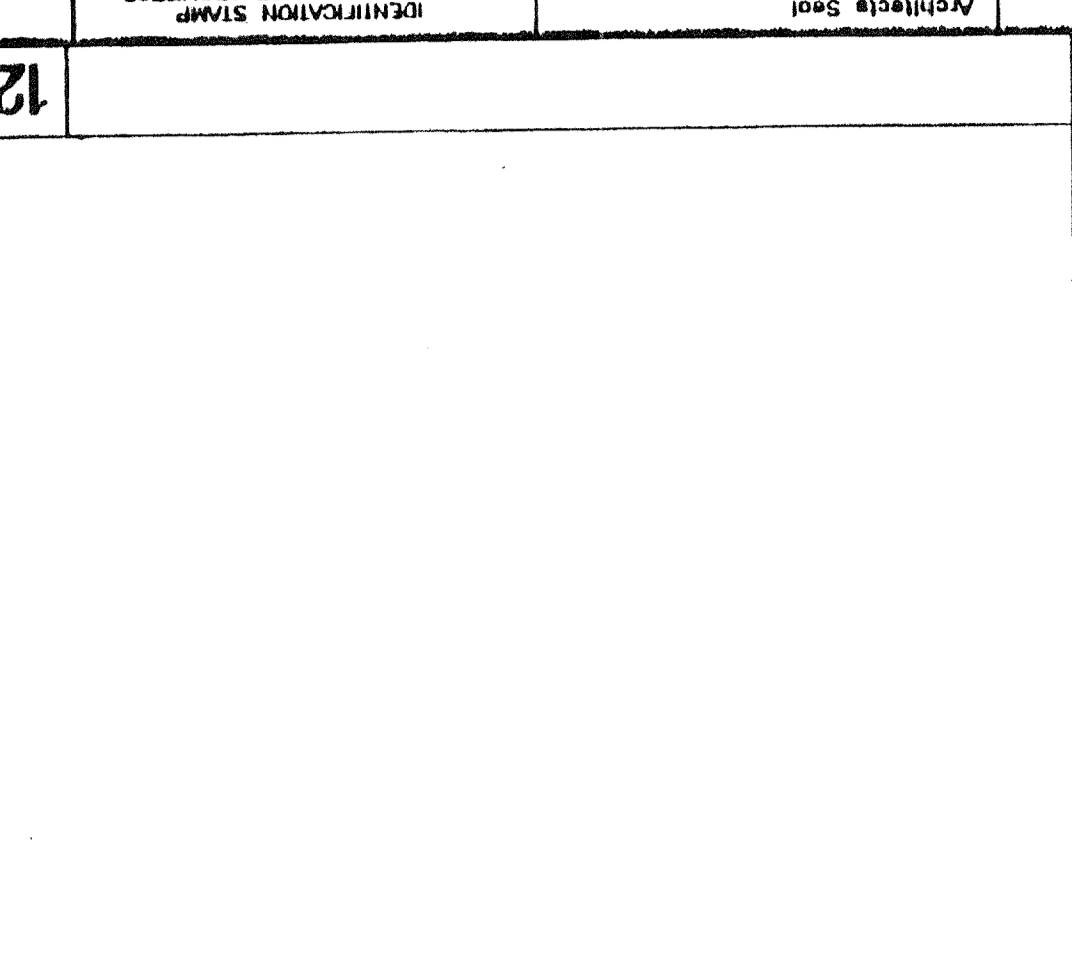
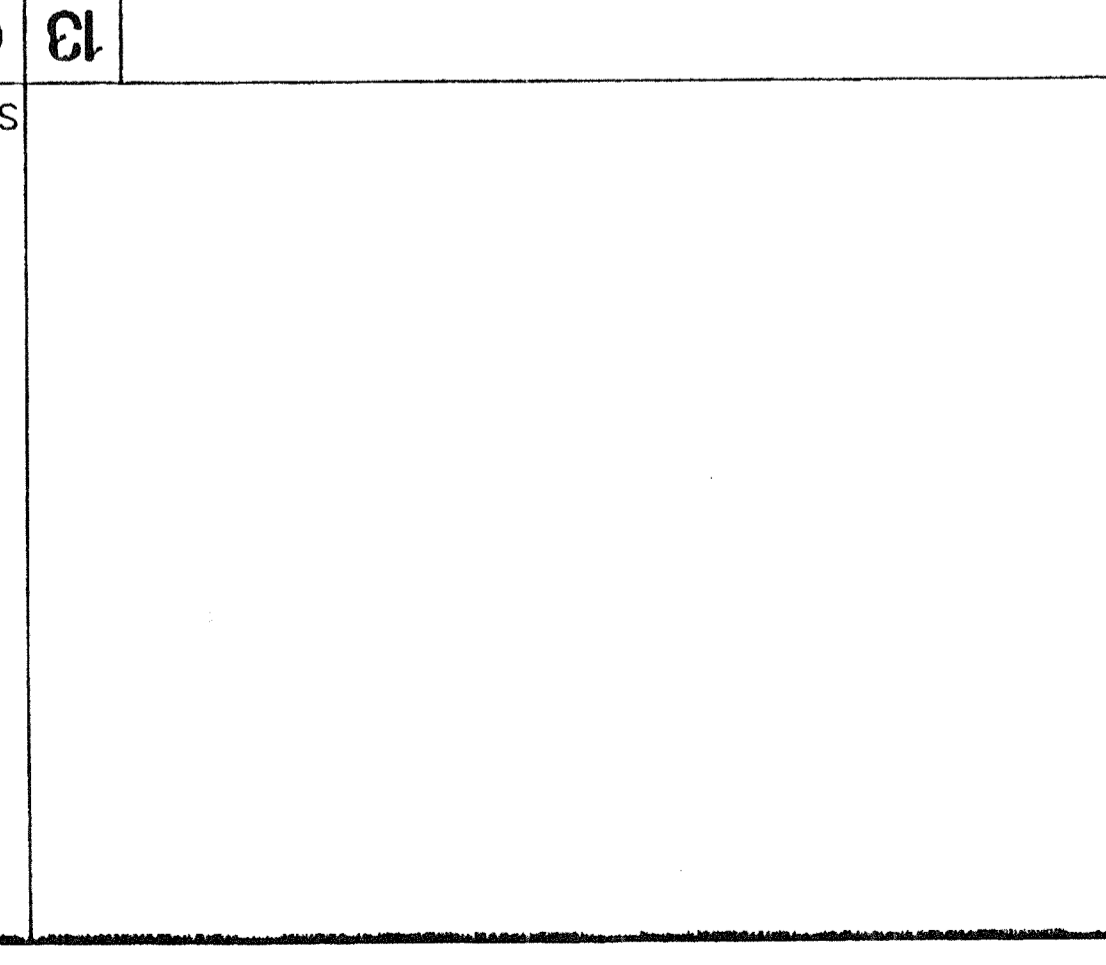
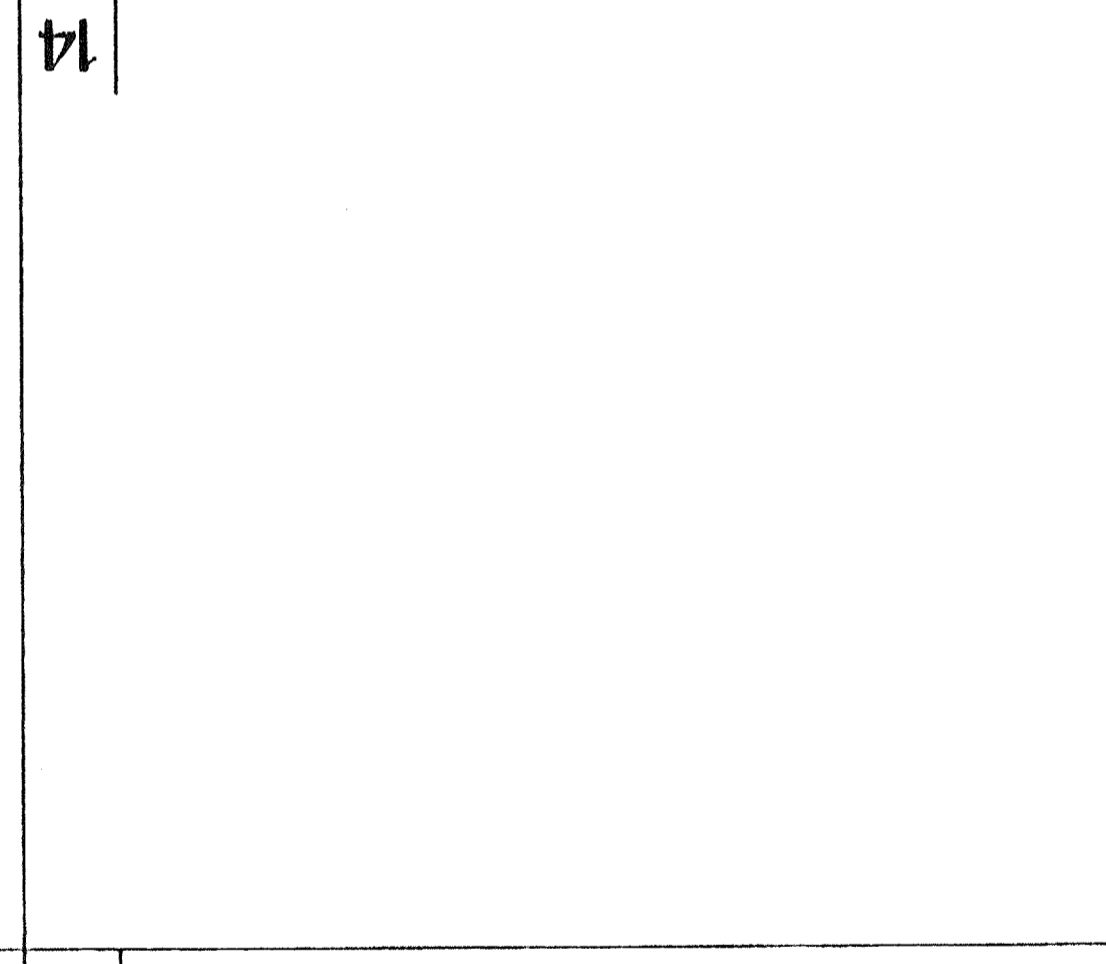
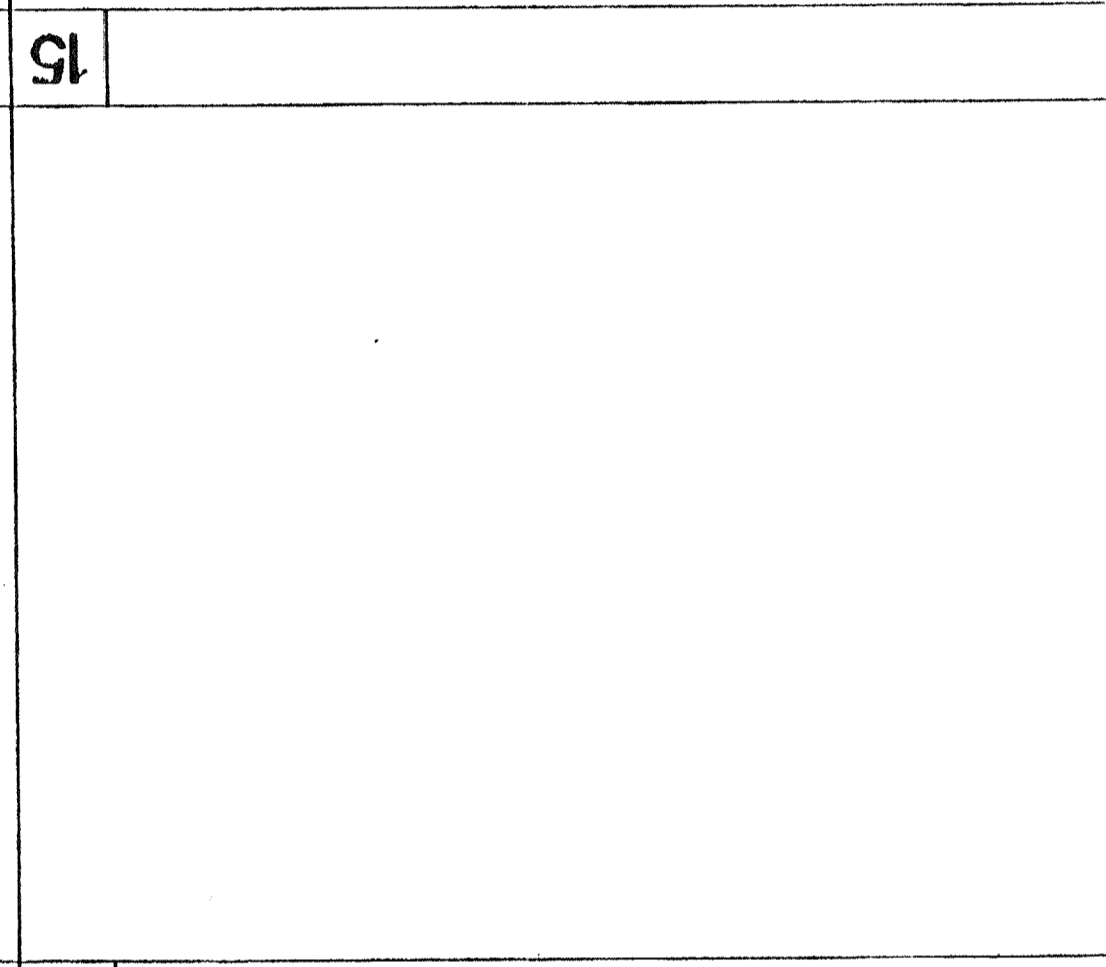
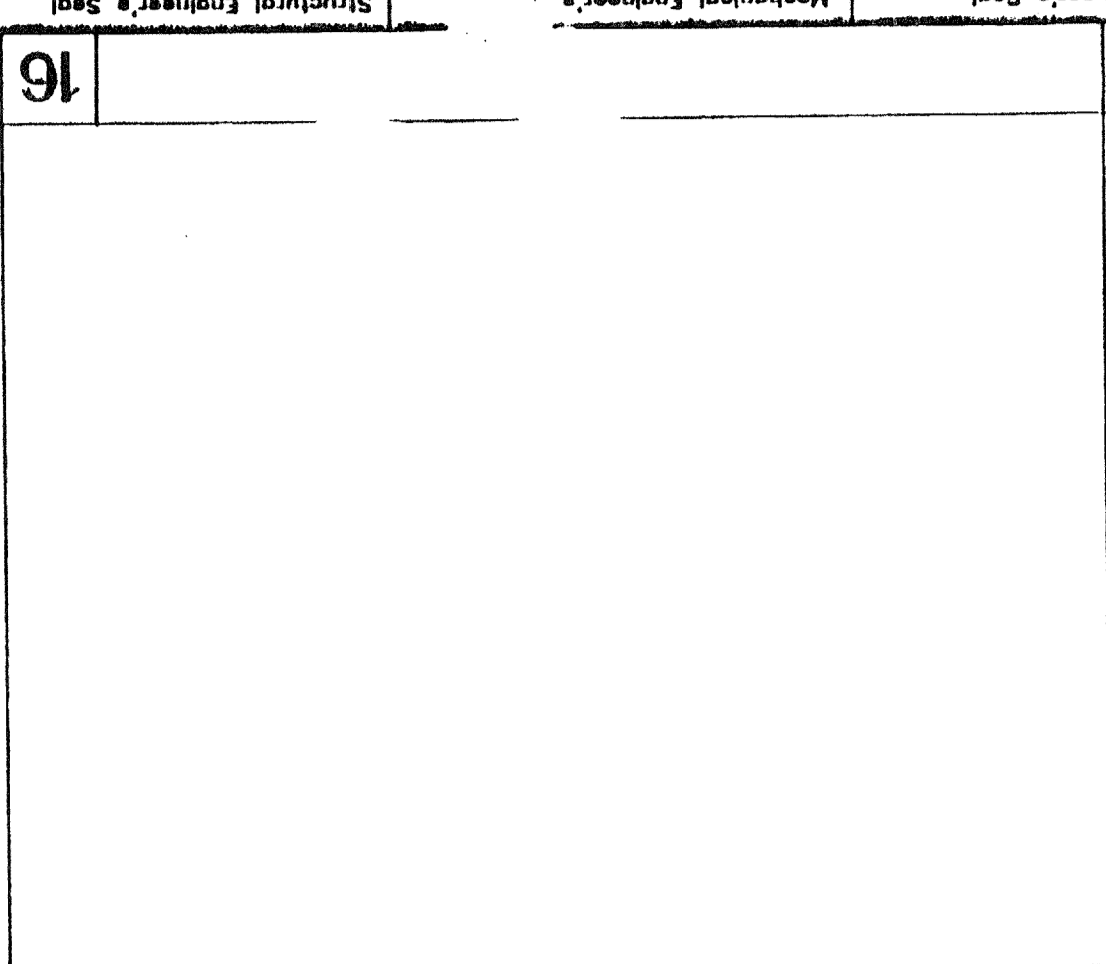
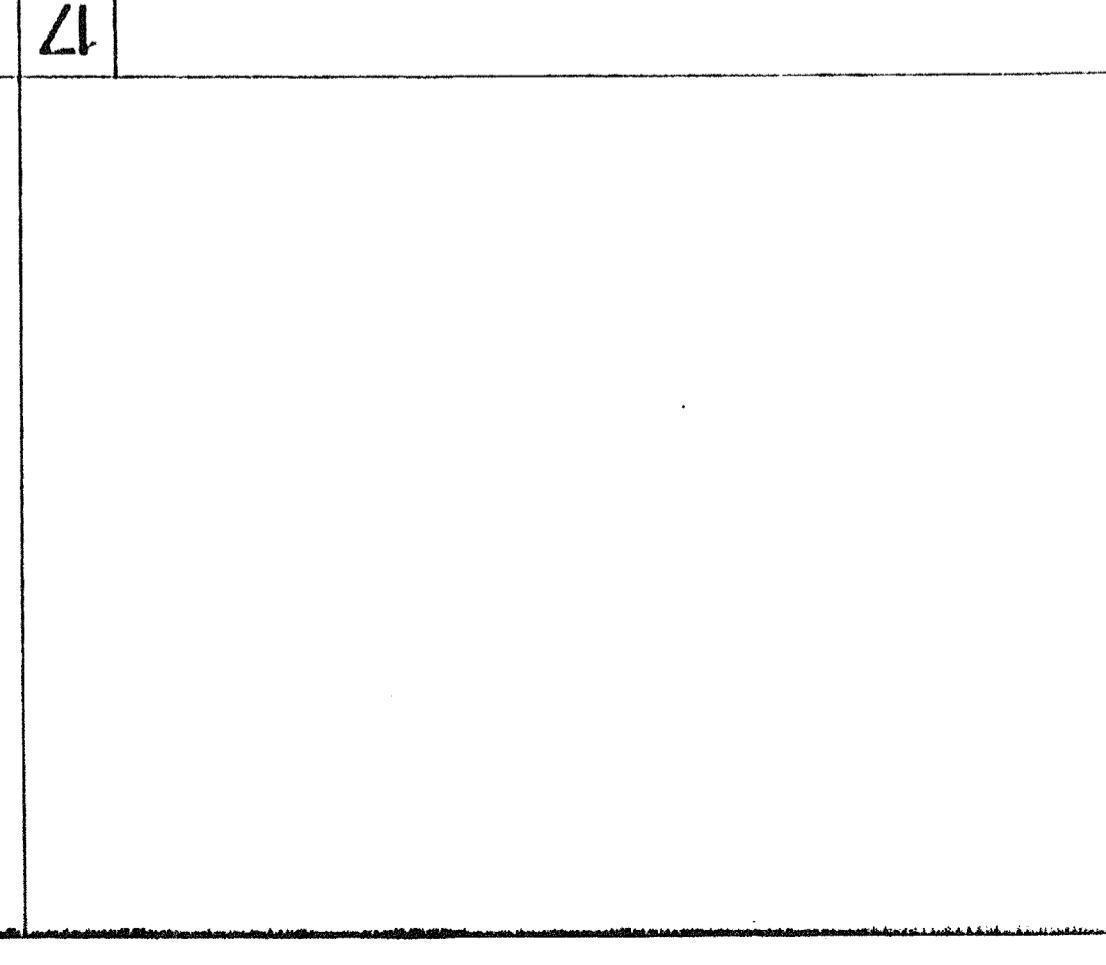
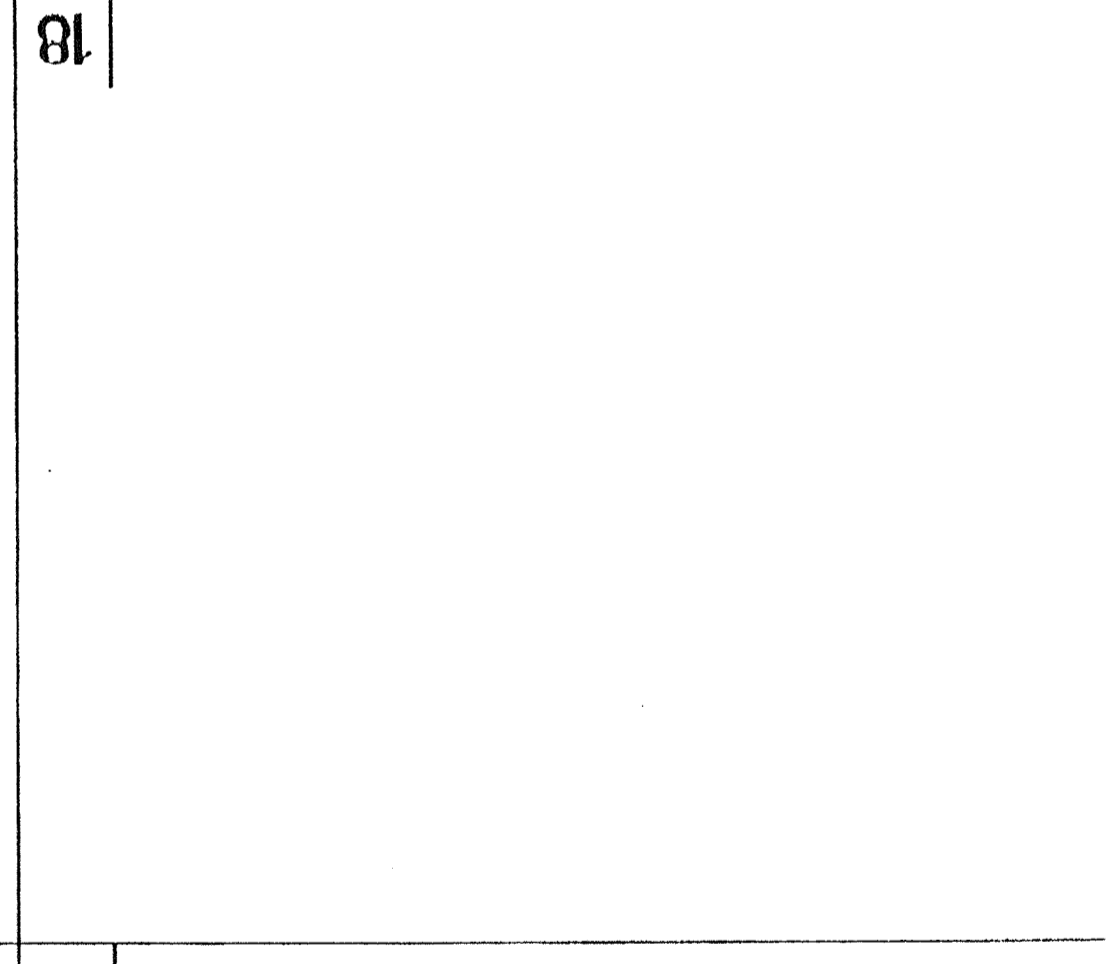
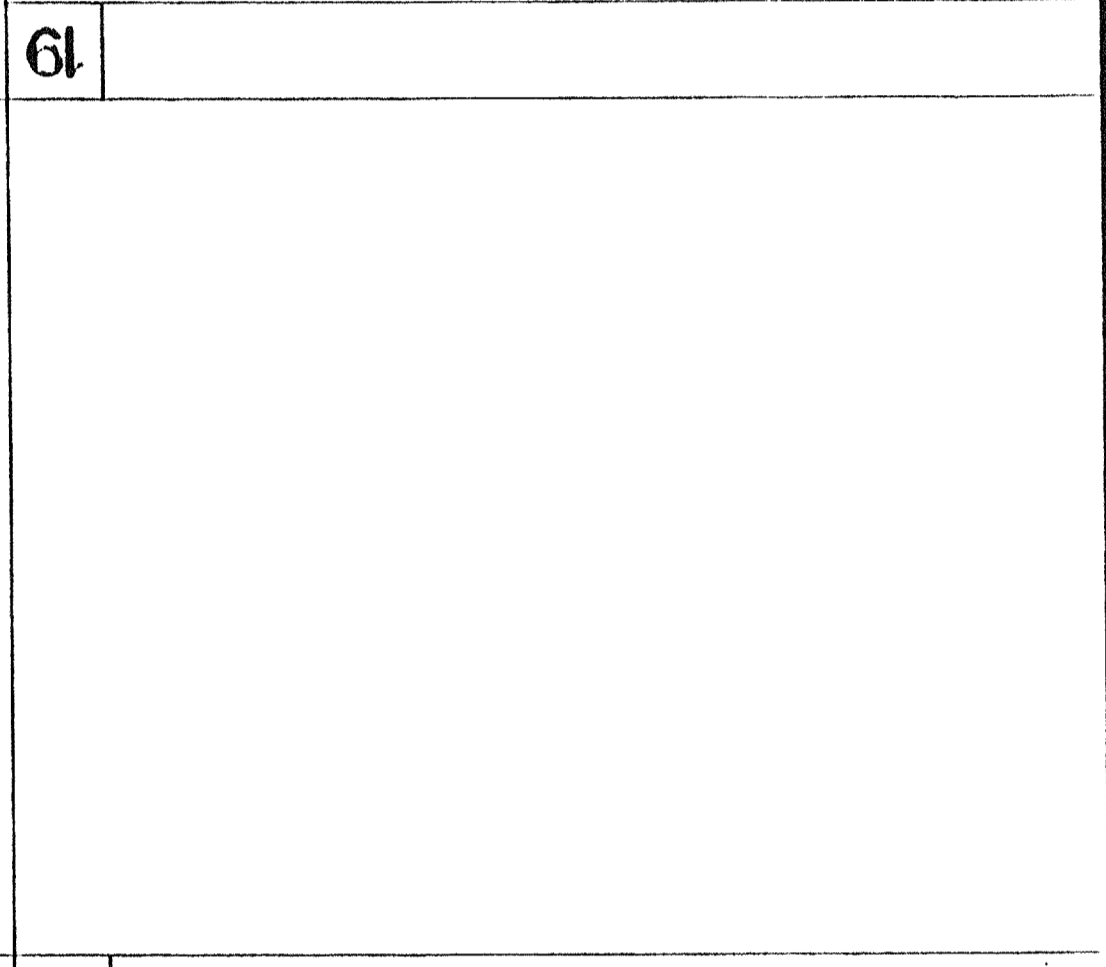
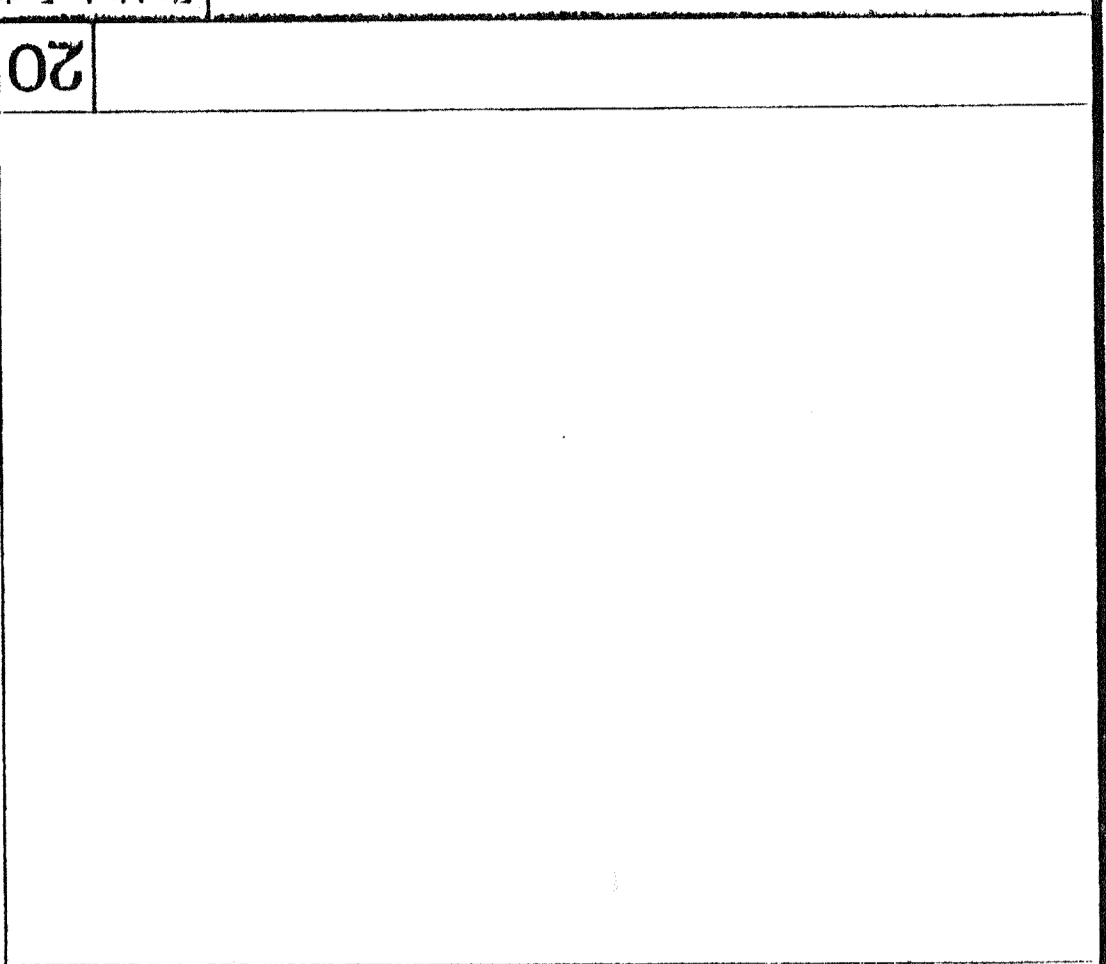

- 1 TYP. INTERIOR FINISH
- 2 TYP. EXTERIOR FINISH
- 3 #14STMS X 3/4" W/NEO WASHTR 3 PER PAN
MAX 6" O.C.
- 4 2X4 STUD TYP. 16" O.C.
- 5 1 1/2"X1 1/2" X 22GA 7 CLIP AT 32" O.C.
- 6 TUBE STEEL SEE STR
- 7 1 1/2"X1 1/2" X 20GA COPED ANGLE W/2
#10 STMS TO PURLIN (TYP) AT 8'-0" O.C.
- 8 SEALANT TYP. (SEE SPECIFICATIONS)
- 9 EXTERIOR WALL (SEE S5.1 FOR CONNECTIONS)
- 10 #14 STMS AT EA STANDING RIB (16" OC)
- 11 DOWNSPOUT
- 12 #8 STMS- 1 AT EA SIDE OF DOWNSPOUT
TO BRACKET
- 13 (1) - #14 STMS W/NEOPRENE WASHER
THROUGH RIB
- 14 ATTACHMENT BRACKET(TYP 3 PLACES: TOP,
BOTTOM & MIDSPAN W/ 2-#10 STMS,
BRACKET TO STUD)
- 15 2 X 4 SILL PLATE PER 4/S5.1
- 16 ROOF HEADER SEE STR
- 17 GI FLASHING 22GA
- 18 STANDING SEAM ROOF (SEE A2.0 FOR GA.)
- 19 ROOF PURLIN SEE STR
- 20 FLOOR BEAM SEE STR
- 21 NOT USED
- 22 CONTINUOUS 26GA. GUTTER (SEE 9/A6.1)
- 23 INSULATION (SEE SPECS FOR TYPE AND SIZE)
(SEE NOTES/A6.1 FOR BURNING DATA)
- 24 #14 STMS AT EACH CLIP (32" O.C.)

KEY NOTES

DATE: SEP 02 1999
AC FLS 23
SS 24
04 101527
OFFICE OF REGULATION SERVICES
DIV. OF THE STATE ARCHITECT
DATE: MAR 20 1999
REVISED
DATE: SEP 01 1999

PROJECT NO. PC-270

FILE PATH: PC270A61.DWG