

EXTERIOR DOOR HEADS (JAMBS SIMILAR) SCALE 3/4"=1'-0"

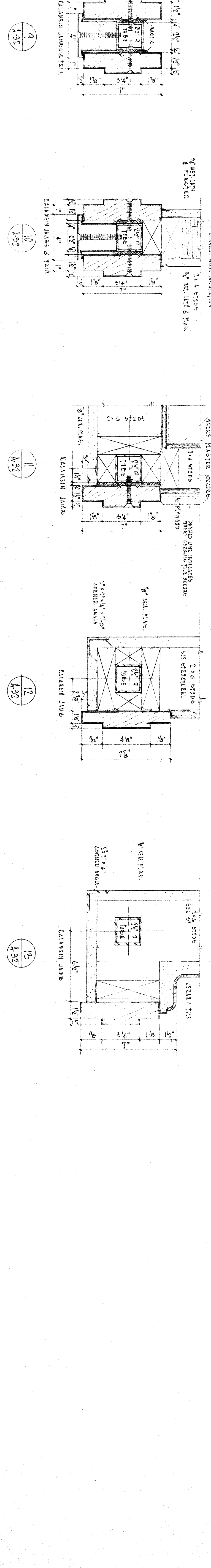

EXTERIOR DOOR JAMBS SCALE 3/4"=1'-0"

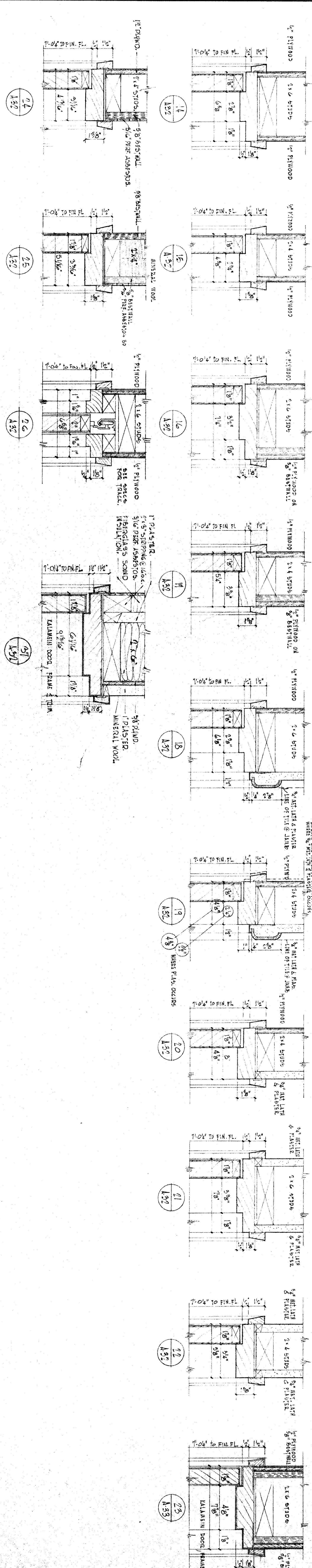

INTERIOR DOOR HEADS (JAMBS SIMILAR) SCALE 3/4"=1'-0"

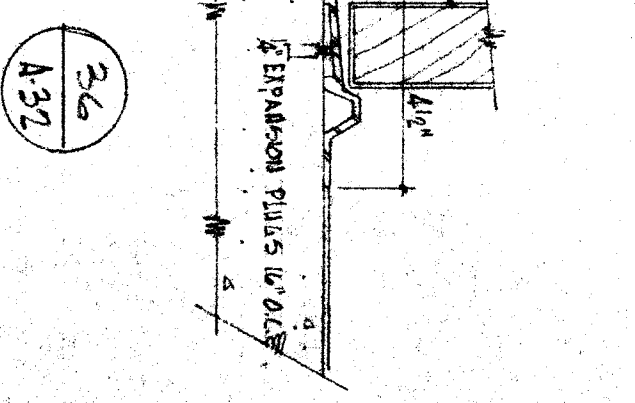
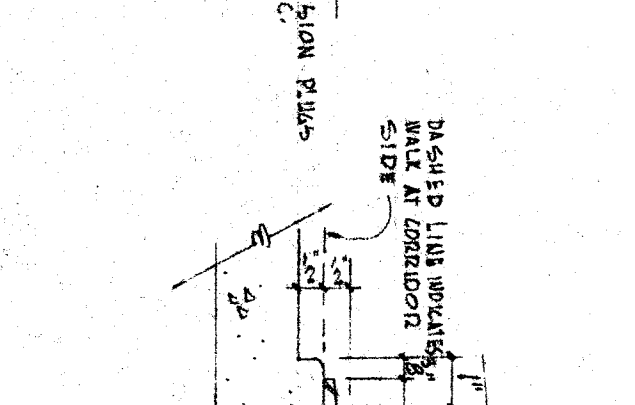
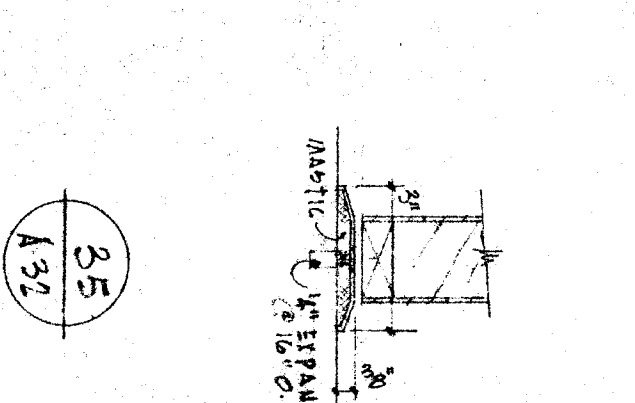
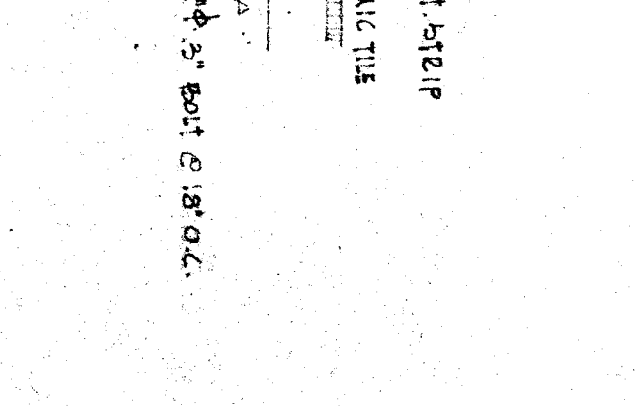
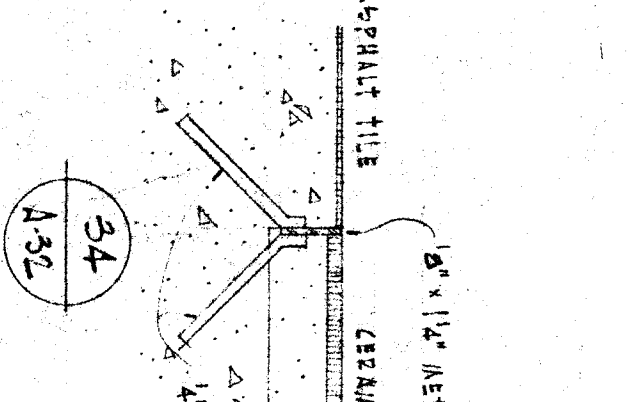
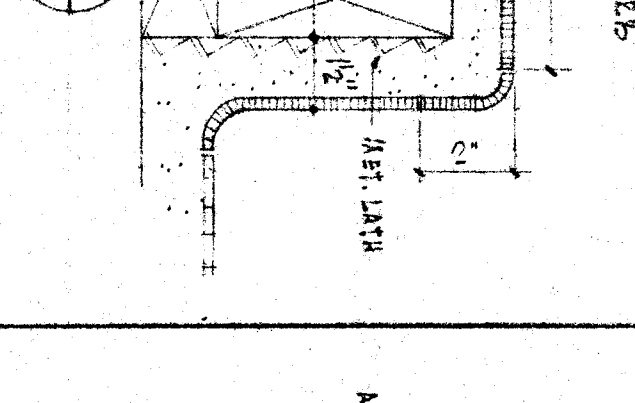
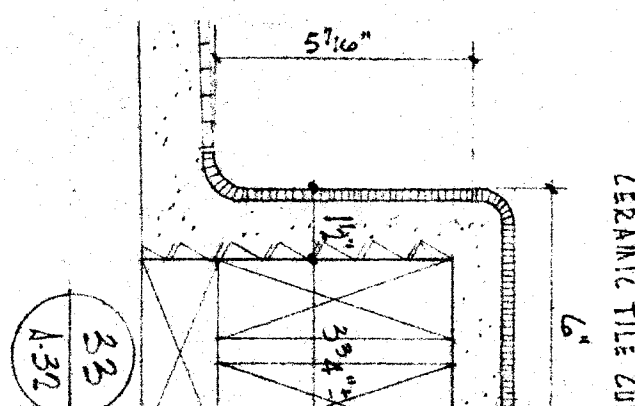
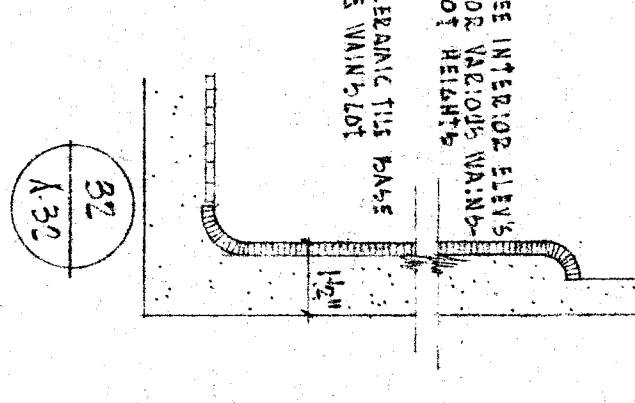
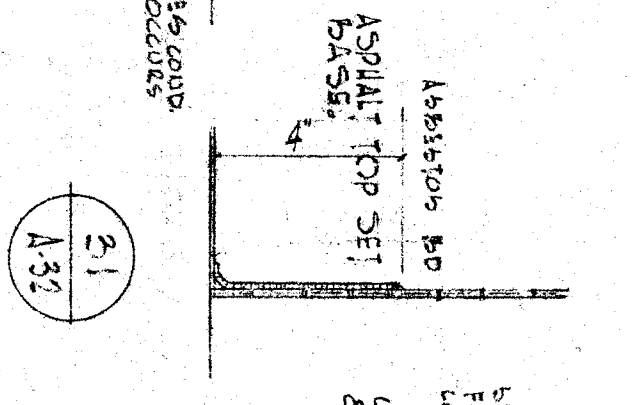
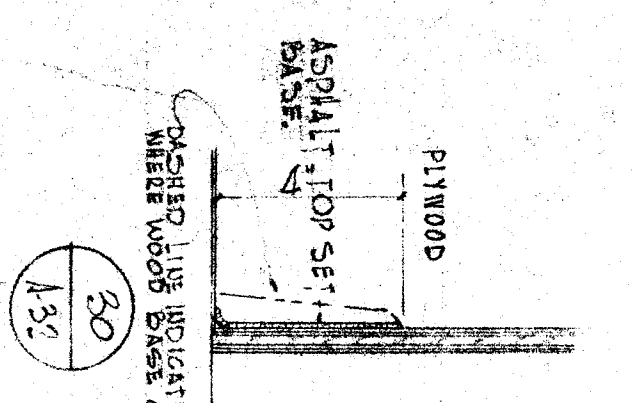
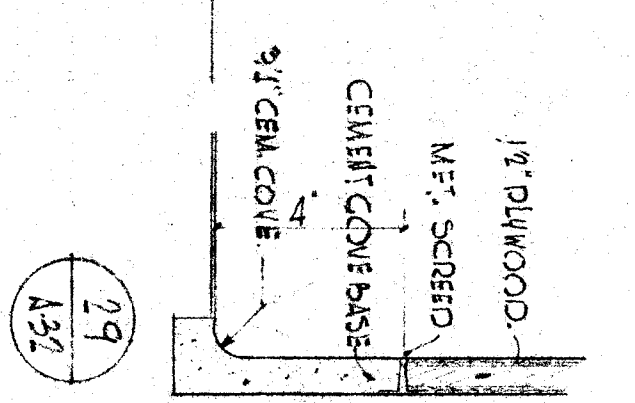
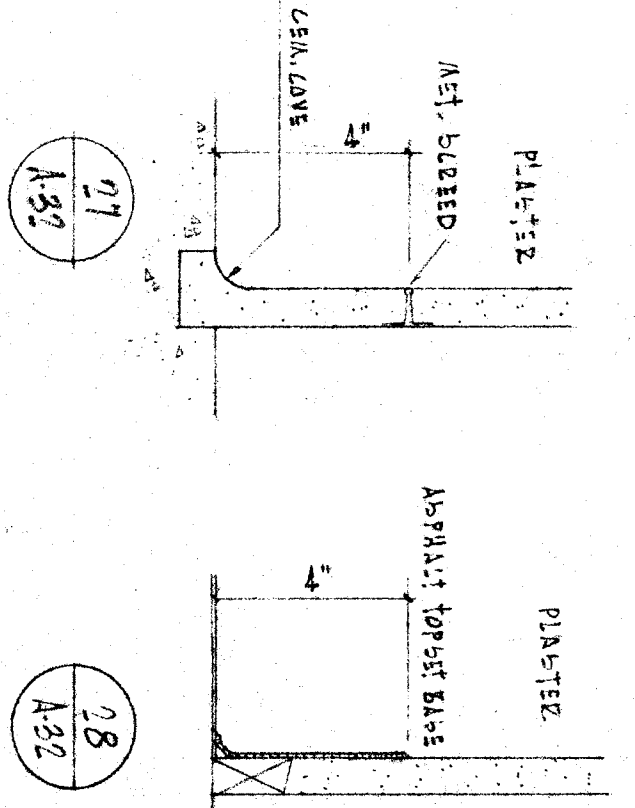
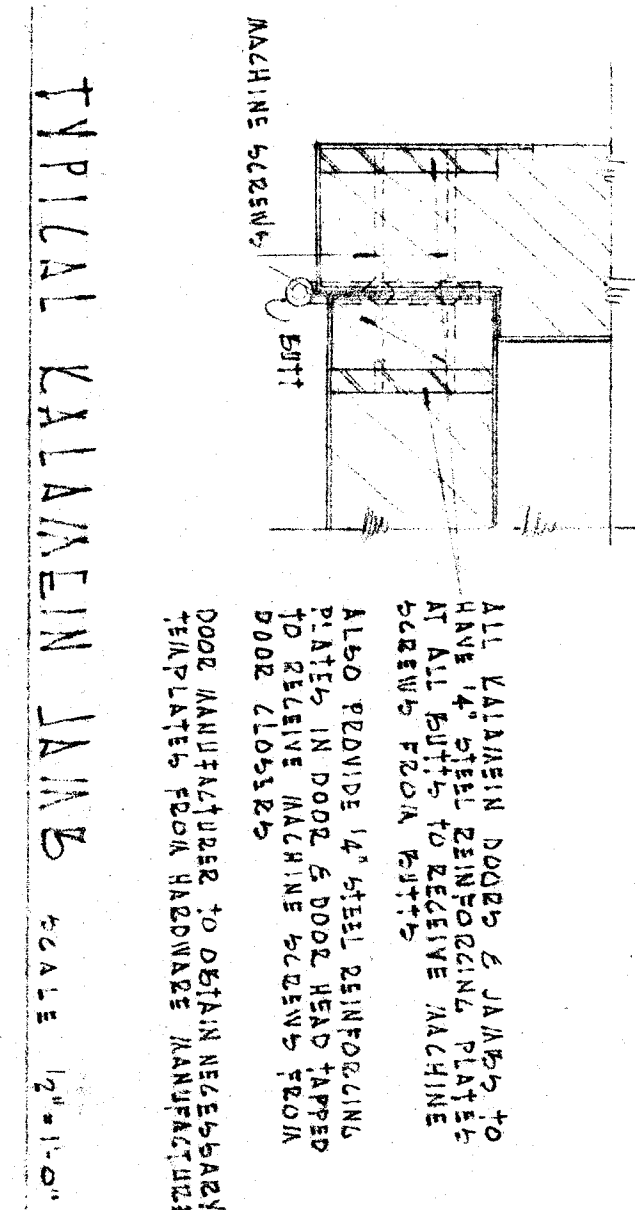

BASE DETAILS SCALE 3/4"=1'-0"

THRESHOLD DETAILS SCALE 3/4"=1'-0"

DOOR, BASE & THRESHOLD DETAILS

ALL LATH AND PLASTER JAMBS TO BE FINISHED WITH PLASTER AND PAINT. ALSO FINISH WITH PLASTER AND PAINT. DOOR JAMBS TO BE FINISHED WITH PLASTER AND PAINT. DOOR HEADS TO BE FINISHED WITH PLASTER AND PAINT. DOOR THRESHOLDS TO BE FINISHED WITH PLASTER AND PAINT.

PLASTER
ART. BRICK
CONCRETE
WOOD

PLASTER
ART. BRICK
CONCRETE
WOOD

PLASTER
ART. BRICK
CONCRETE
WOOD

PLASTER
ART. BRICK
CONCRETE
WOOD

PLASTER
ART. BRICK
CONCRETE
WOOD

PLASTER
ART. BRICK
CONCRETE
WOOD

PLASTER
ART. BRICK
CONCRETE
WOOD

PLASTER
ART. BRICK
CONCRETE
WOOD

PLASTER
ART. BRICK
CONCRETE
WOOD

PLASTER
ART. BRICK
CONCRETE
WOOD

PLASTER
ART. BRICK
CONCRETE
WOOD

PLASTER
ART. BRICK
CONCRETE
WOOD

PLASTER
ART. BRICK
CONCRETE
WOOD

69
126
20
1/15/34
1/26/34

OFFICE OF SUPERINTENDENT OF SCHOOLS
APPROVED DATE

STATE OF CALIFORNIA
DEPARTMENT OF PUBLIC WORKS
DIVISION OF ARCHITECTURE

STATE OF CALIFORNIA - DEPARTMENT OF PUBLIC WORKS
DIVISION OF ARCHITECTURE
APPROVED DATE

BAKERFIELD CITY SCHOOLS
1600 K ST. BAKERFIELD, CALIF.
BOARD OF EDUCATION

APPROVED DATE

WALTER H. MCGOWAN JR. ARCHITECT
3811 H STREET
BAKERFIELD
CALIFORNIA

DOOR, BASE & THRESHOLD DETAILS

DATE
DRAWN
CHECKED
BY