

NORTH
ELEVATIONS OF PRINCIPALS OFFICE
A-20

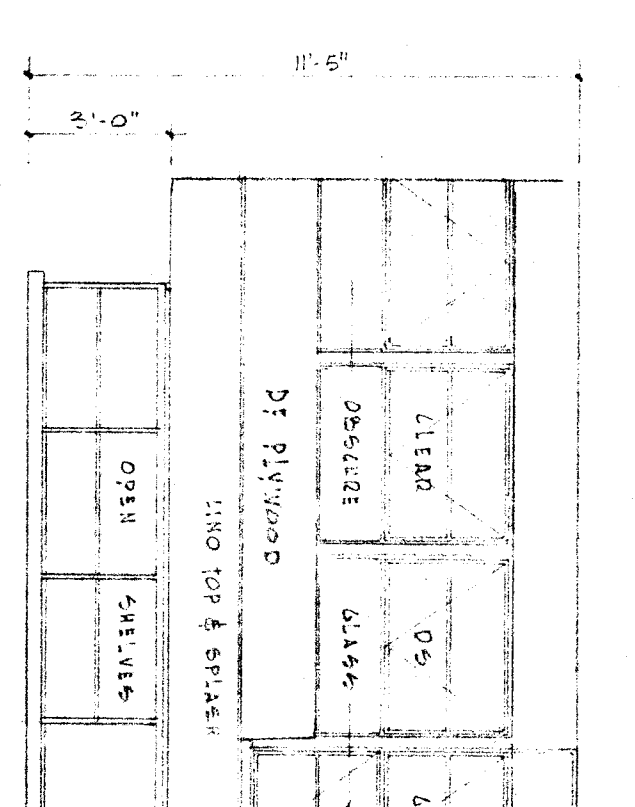

NORTH
ELEVATIONS OF SUPPLY ROOM
A-16

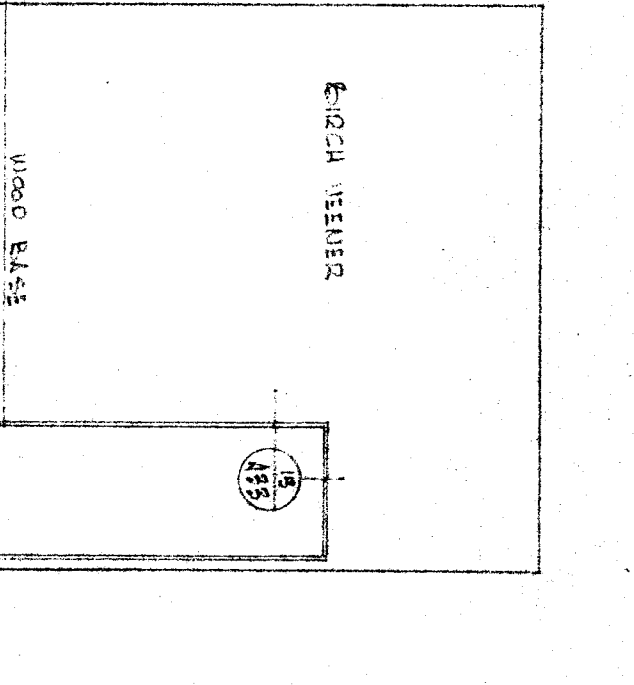
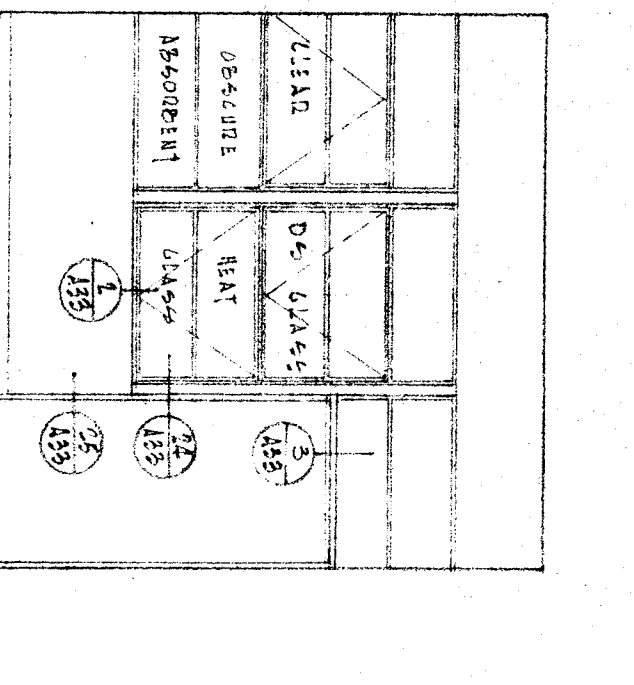
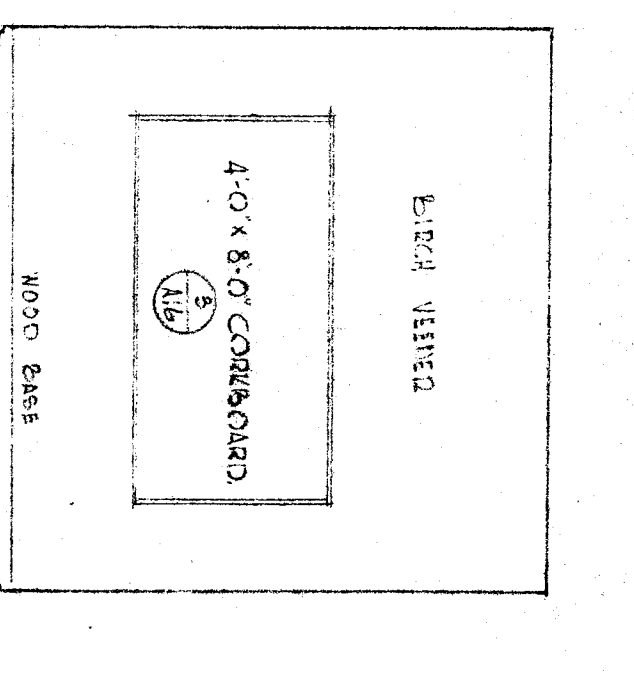
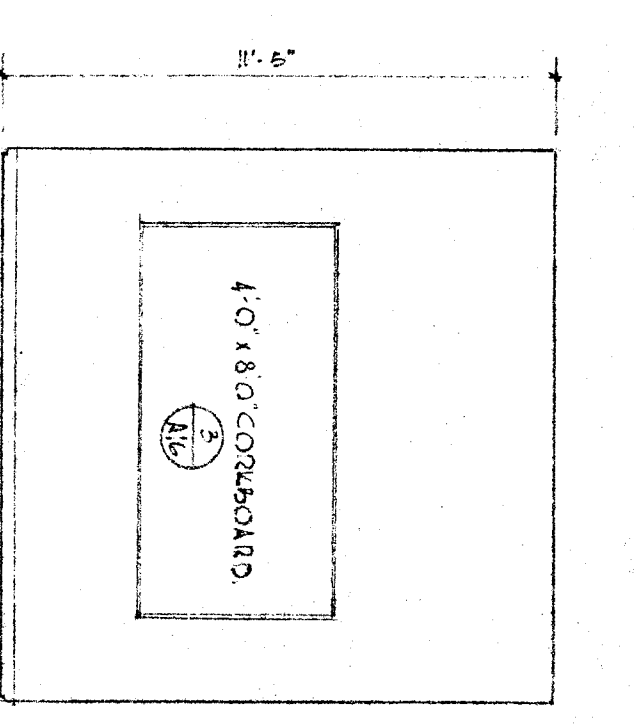
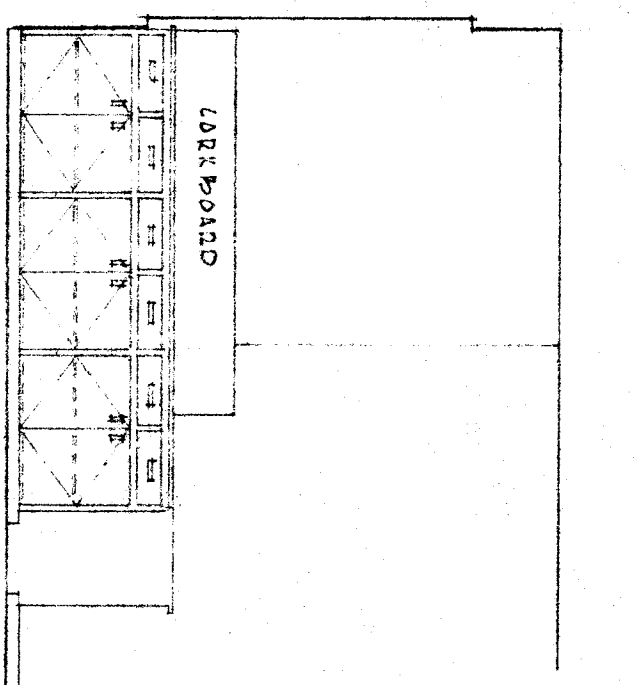
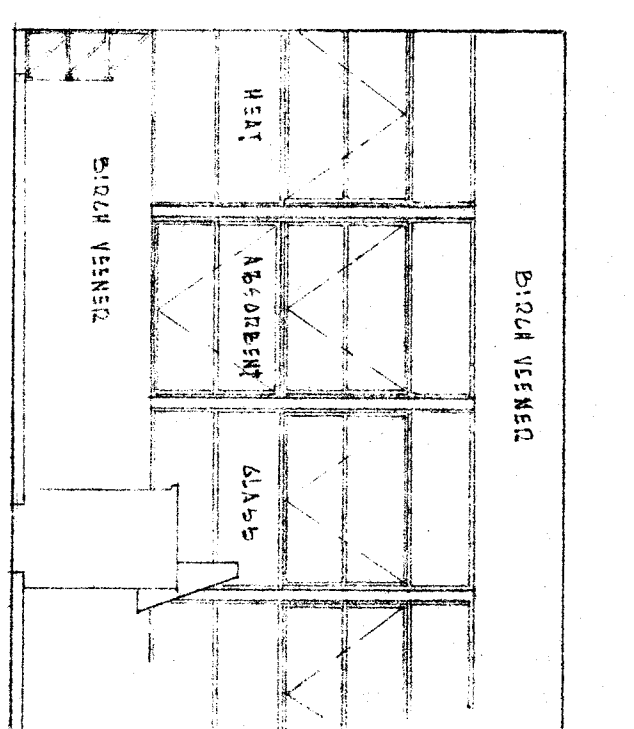
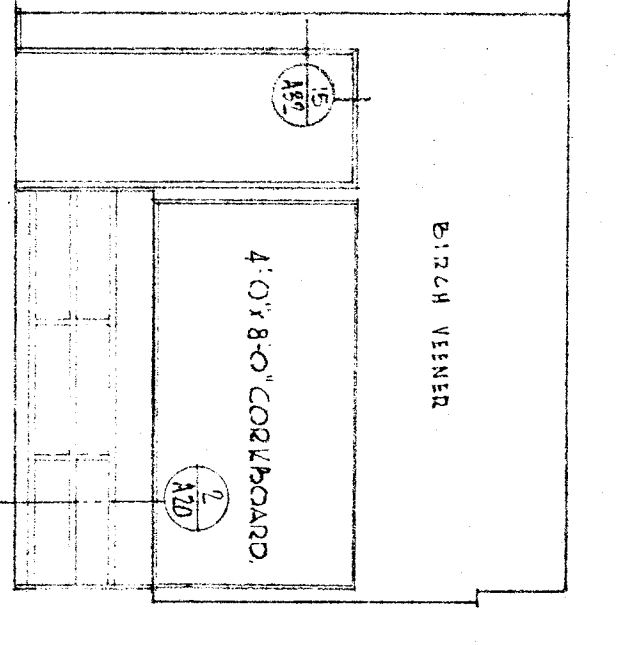
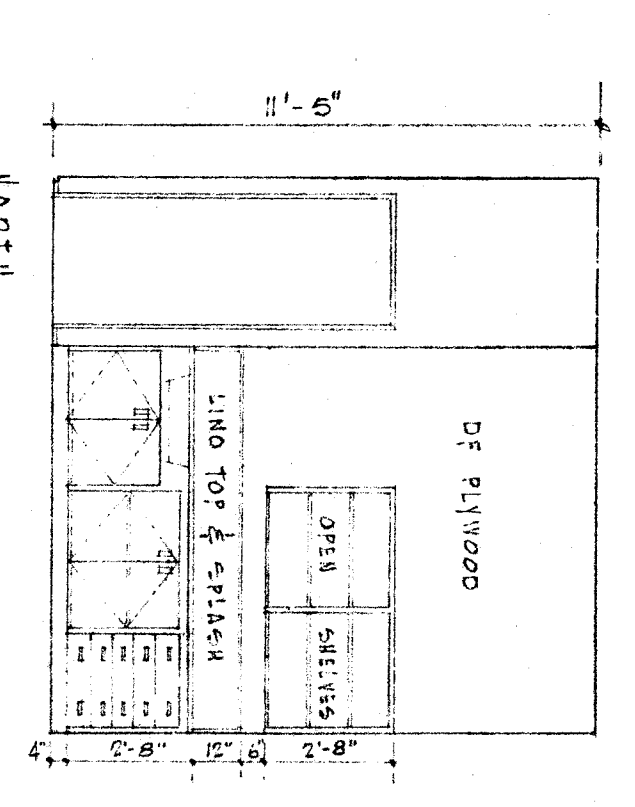
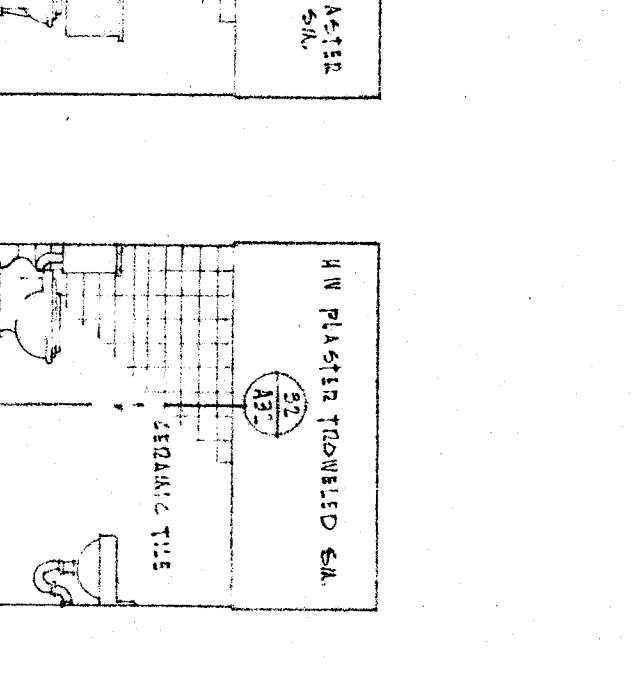
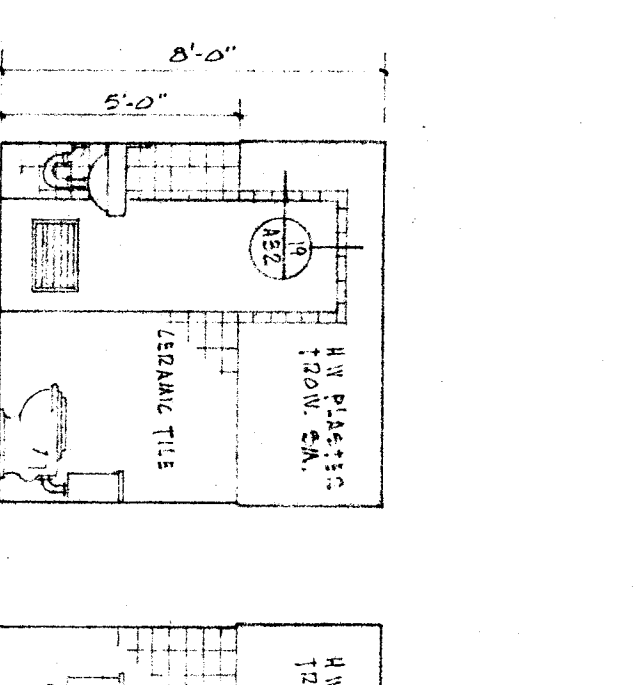
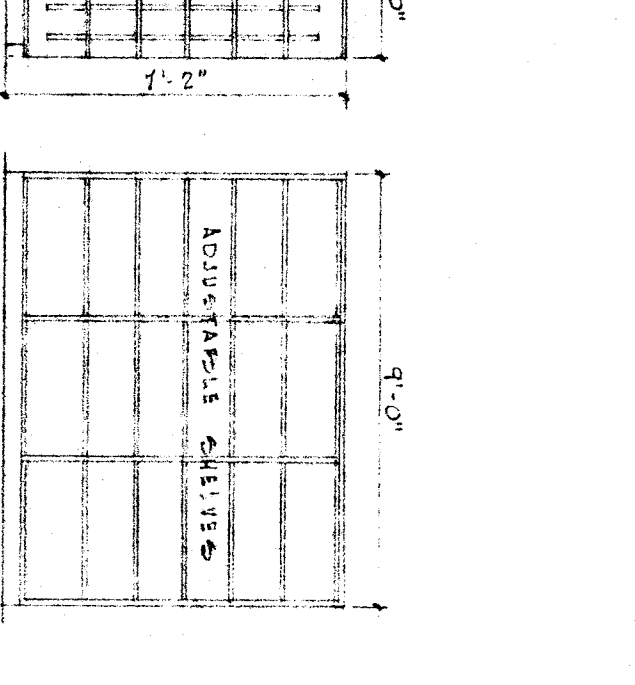
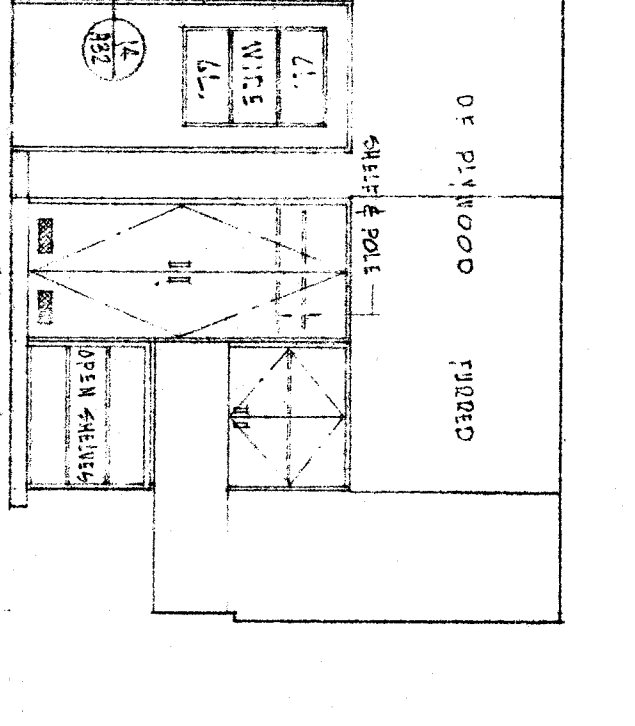
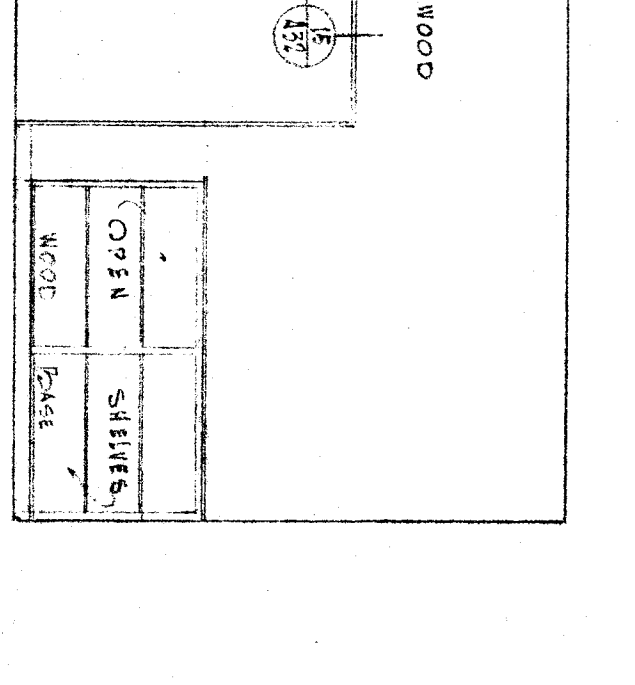
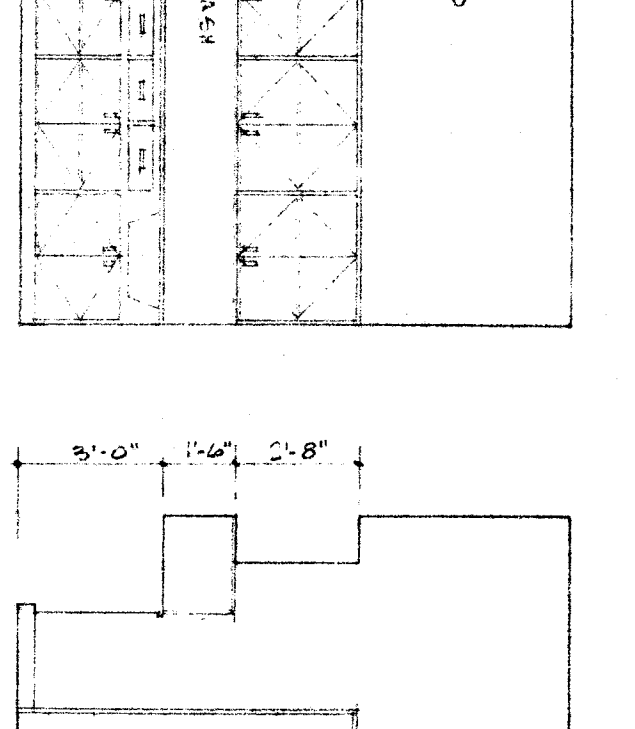
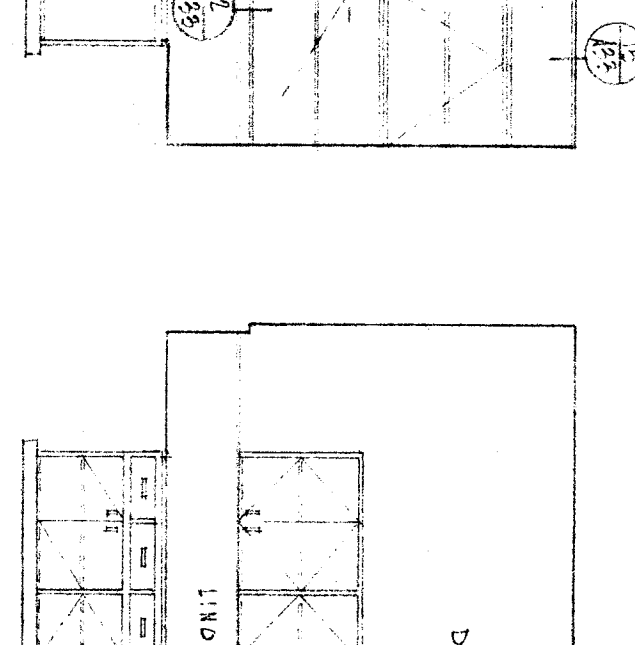

NORTH
ELEVATIONS OF CHECK OUT ROOM
A-10

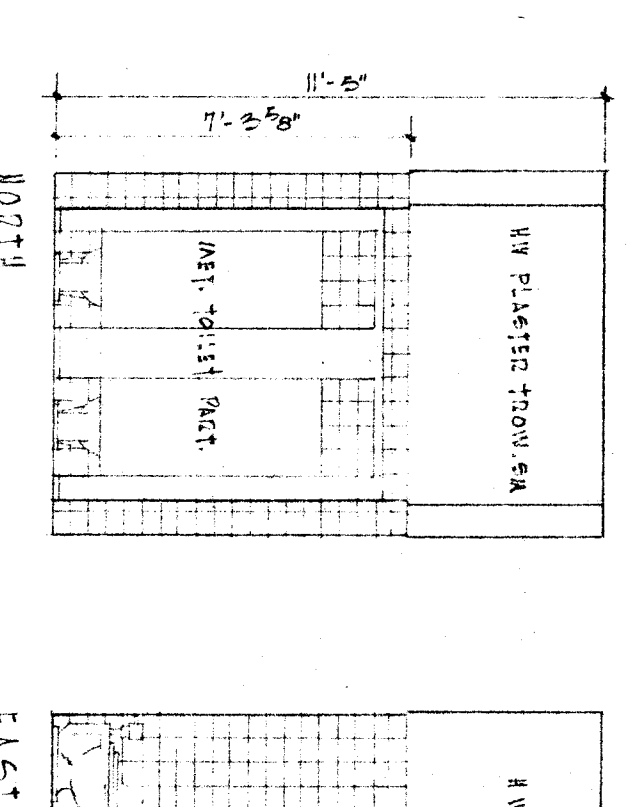
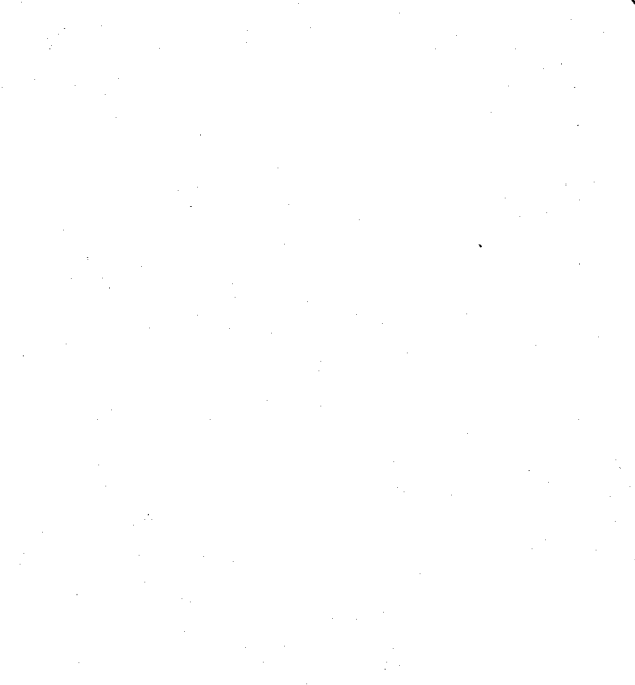
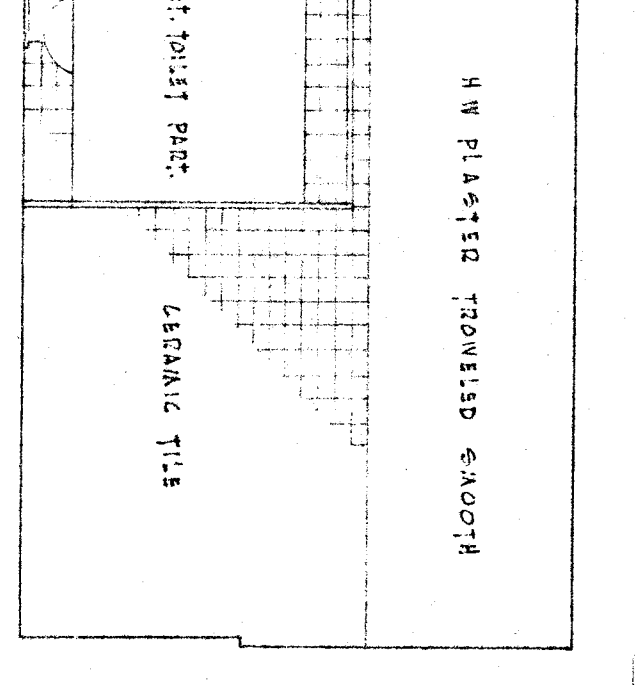
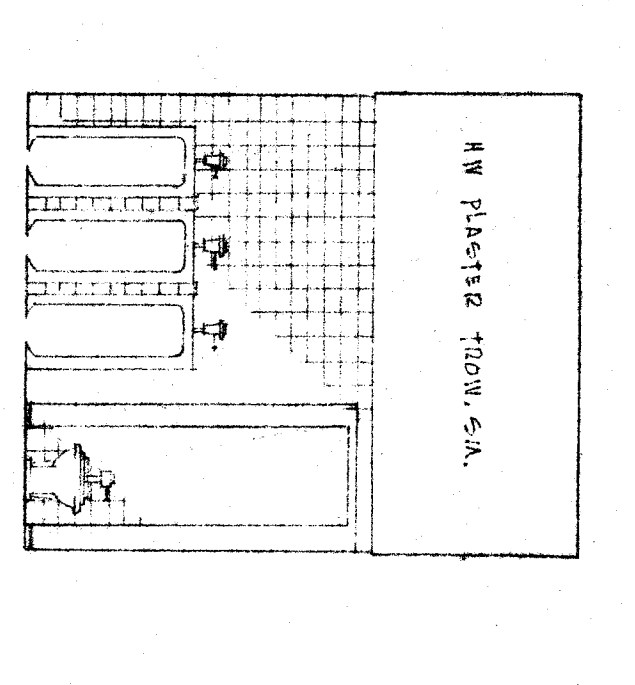
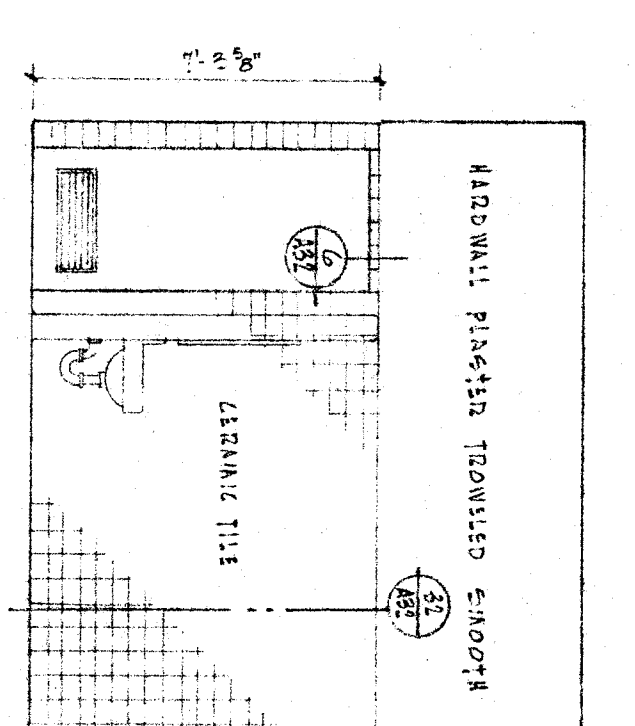
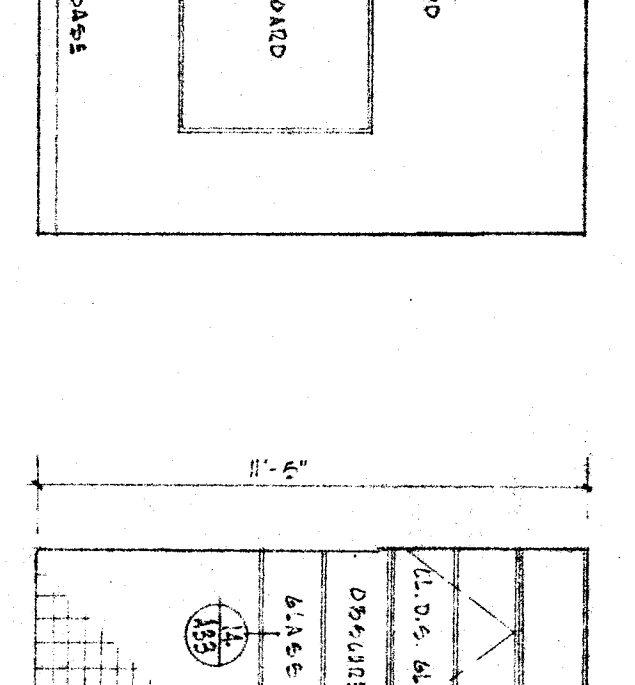
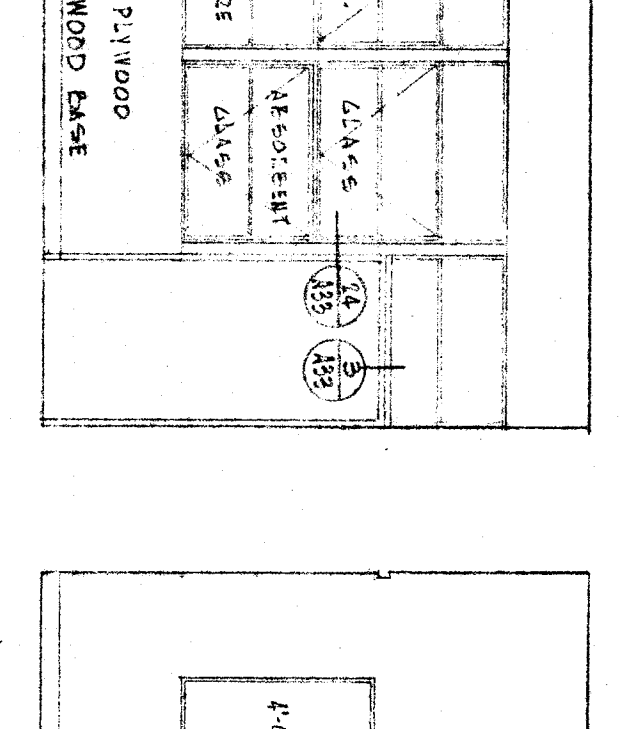
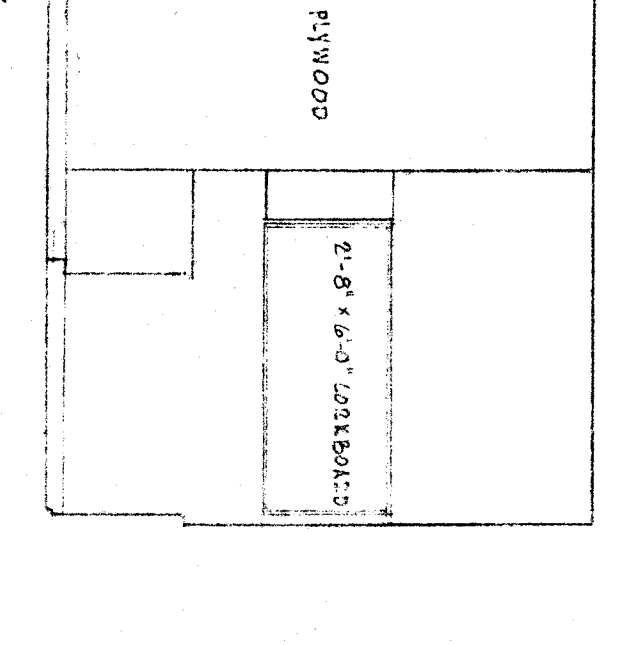

NORTH
ELEVATIONS OF GIRLS TOILET
A-8

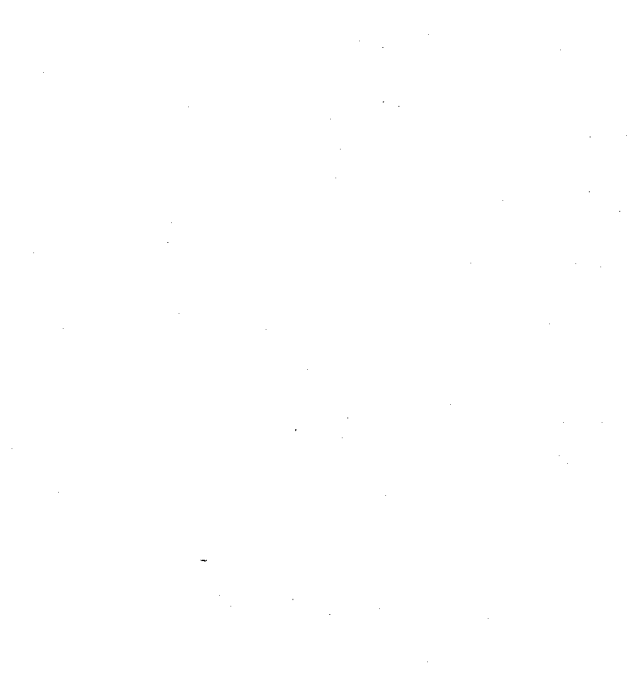
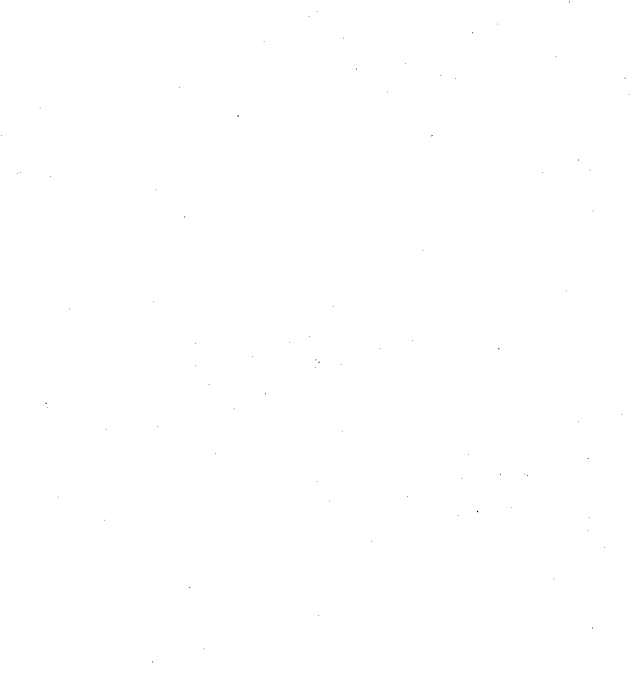
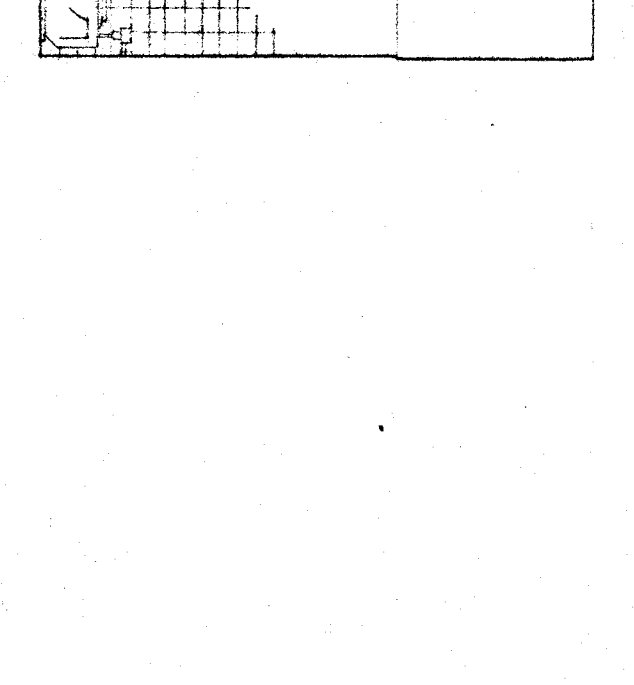
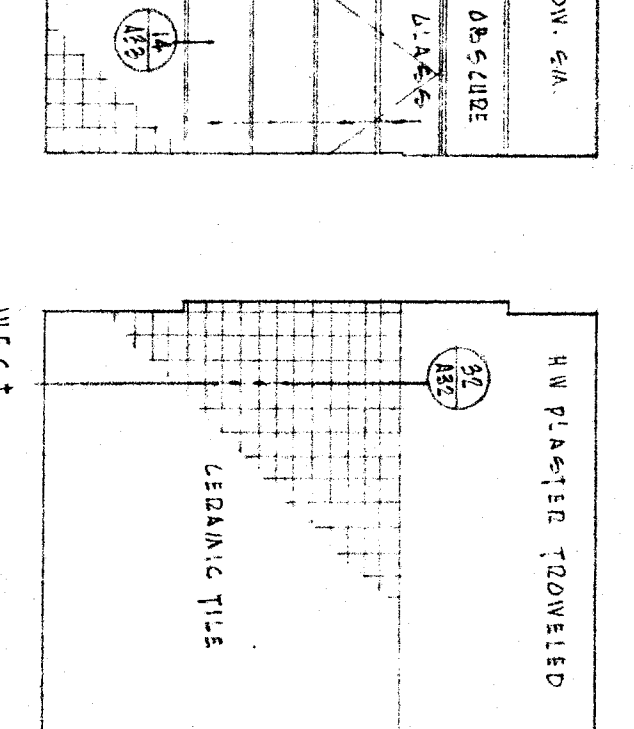
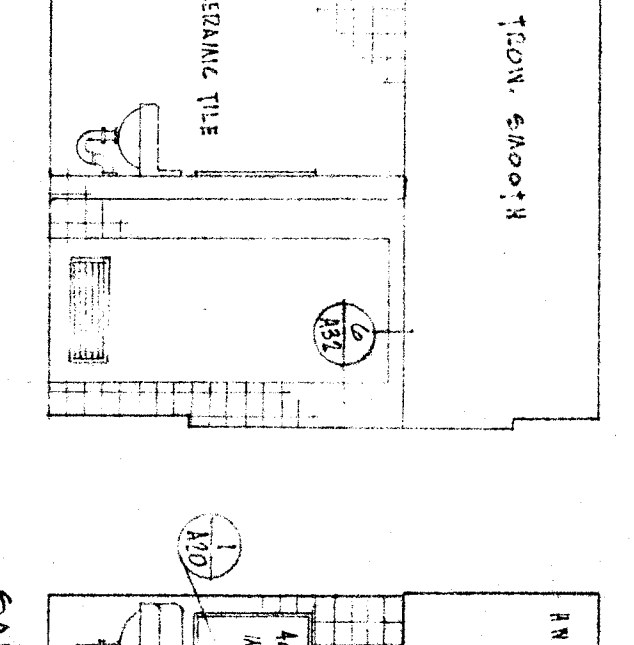

NORTH
ELEVATIONS OF CONFERENCE ROOM
A-25

SECTION & ELEVATION OF SLANTING SHELVES
IN SUPPLY ROOM A-16 (SEE PLAN FOR LOCATION)

NORTH
ELEVATIONS OF TOILET TR
A-12

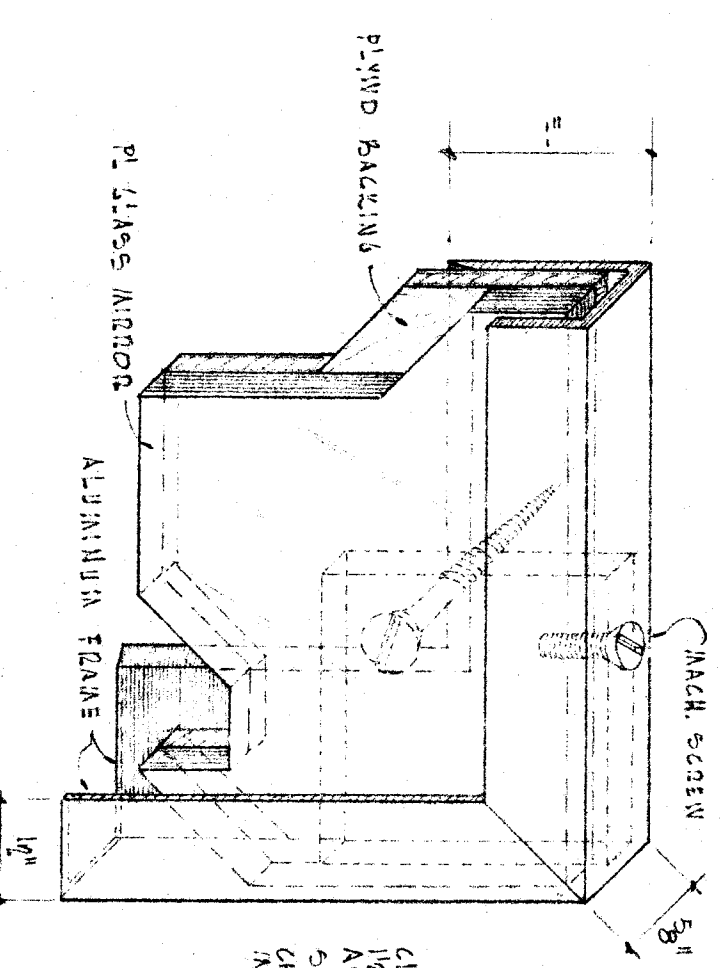

1. MIRROZ ATTACHMENT
SCALE: 1/4" = 1'-0"

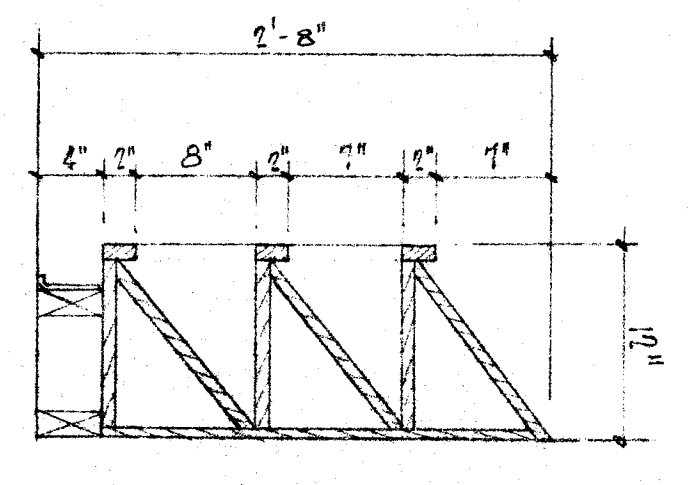

2. SLANTING BOOK SHELVES
SCALE: 1/4" = 1'-0"

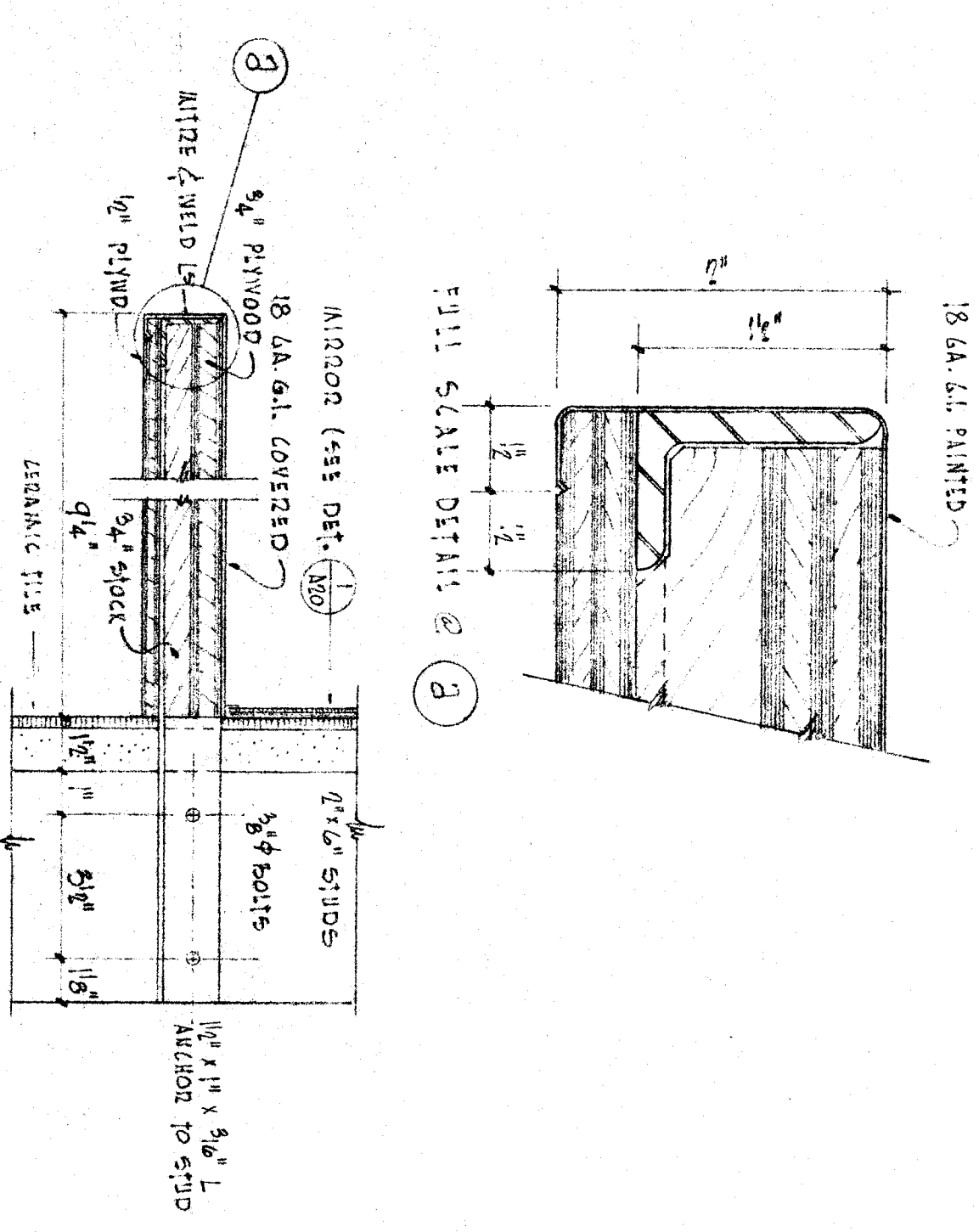

3. SHELF DETAIL
SCALE: 1/4" = 1'-0"

20
8/1/54
A-6
APPROVED
DATE

OFFICE OF SUPERINTENDENT OF SCHOOLS
DEPARTMENT OF PUBLIC WORKS
DIVISION OF ARCHITECTURE

STATE OF CALIFORNIA
DEPARTMENT OF PUBLIC WORKS
DIVISION OF ARCHITECTURE

STATE OF CALIFORNIA - DEPARTMENT OF PUBLIC WORKS
DIVISION OF ARCHITECTURE
APPROVED
DATE

BAIRDSEFIELD CITY SCHOOLS
1000 K ST. BAIRDSEFIELD, CALIF.
BOARD OF EDUCATION

APPROVED
DATE

WASHINGTON JR. HIGH SCHOOL
BAIRDSEFIELD CITY SCHOOL DISTRICT
BAIRDSEFIELD CALIFORNIA

ERNEST L. MCCOY A.T.A. ARCHITECT
2811 H STREET
BAIRDSEFIELD CALIFORNIA

DATE
DRAWN
CHECKED
SCALE

INTERIOR ELEVATIONS QMS A-12 THRU A-18 SCALE 1/4" = 1'-0"

