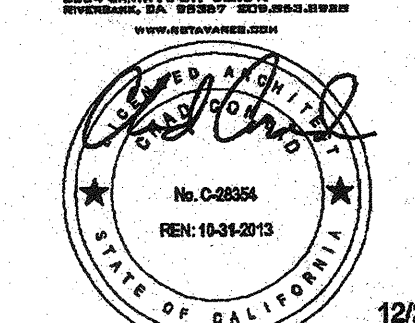

THESE DRAWINGS AND ALL MATERIAL CONTAINED HEREIN ARE THE PROPERTY OF SILVERCREEK INDUSTRIES, INC (SCI Inc) AND SHALL NOT BE REPRODUCED, COPIED OR OTHERWISE DISPOSED OF DIRECTLY OR INDIRECTLY AND SHALL NOT BE USED IN WHOLE OR IN PART TO ASSIST IN THE MAKING OF OR FOR THE PURPOSE OF FURNISHING ANY INFORMATION FOR THE MAKING OF DRAWINGS, PRINTS, APPARATUS OR PARTS THEREOF WITHOUT THE FULL KNOWLEDGE AND WRITTEN CONSENT OF SCI Inc.  
ALL PATENTABLE MATERIAL CONTAINED HEREIN AND ORIGINATING WITH SCI Inc SHALL BE THE PROPERTY OF SCI Inc.

**SILVER CREEK INDUSTRIES, INC.**  
  
 BUILDING FOR THE NEXT GENERATION  
 195 EAST MORGAN PERRIS, CALIFORNIA 92571  
 PHONE: 951-943-5393 FAX: 951-943-2211

PROJECT NAME:  
**CLASS LEASING CLASSROOMS BLDG'S**

SHEET TITLE:  
**CROSS SECTION**

**TAVARES ASSOCIATES**  
 ARCHITECTS  
 1000 S. GARDEN ST. SUITE 200  
 PERRIS, CA 92571  
 WWW.TAVARESARCHITECTS.COM  
  
 No. C-8854  
 Exp. 12-31-2015  
 12/23/2011

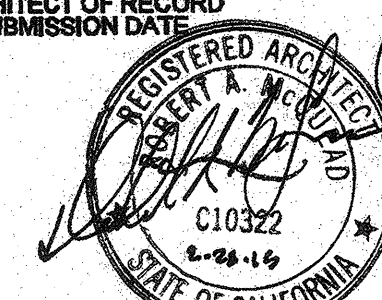
ARCHITECT OF RECORD  
 SUBMISSION DATE  
  
 REGISTERED ARCHITECT  
 ROBERT A. TAVARES  
 C10322  
 2-28-11  
 STATE OF CALIFORNIA

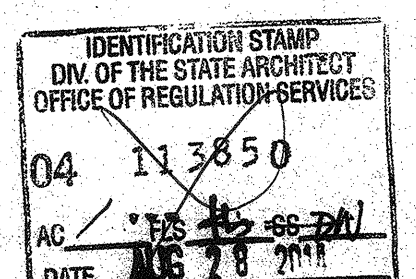
PROJECT SPECIFIC STATE AGENCY APPROVAL  
  
 IDENTIFICATION STAMP  
 DIV. OF THE STATE ARCHITECT  
 OFFICE OF REGULATION SERVICES  
 04 113850  
 AC [Signature]  
 DATE AUG 28 2011

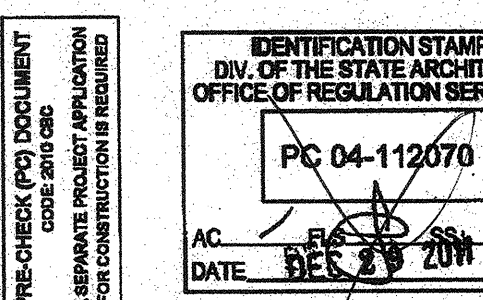
ORIGINAL PC STATE AGENCY APPROVAL  
  
 PRE-CHECK (PC) DOCUMENT  
 A SEPARATE PRELIMINARY APPLICATION FOR CONSTRUCTION IS REQUIRED  
 IDENTIFICATION STAMP  
 DIV. OF THE STATE ARCHITECT  
 OFFICE OF REGULATION SERVICES  
 PC 04-112070  
 AC [Signature]  
 DATE DEC 29 2011

REVISIONS

SILVER CREEK INDUSTRIES  
 30' x 32' PC  
 PROJECT NO:  
 DRAWN BY:  
 SCALE: AS NOTED  
 DATE: 6-17-11  
 P.C. SHEET NUMBER  
**A-5.05**

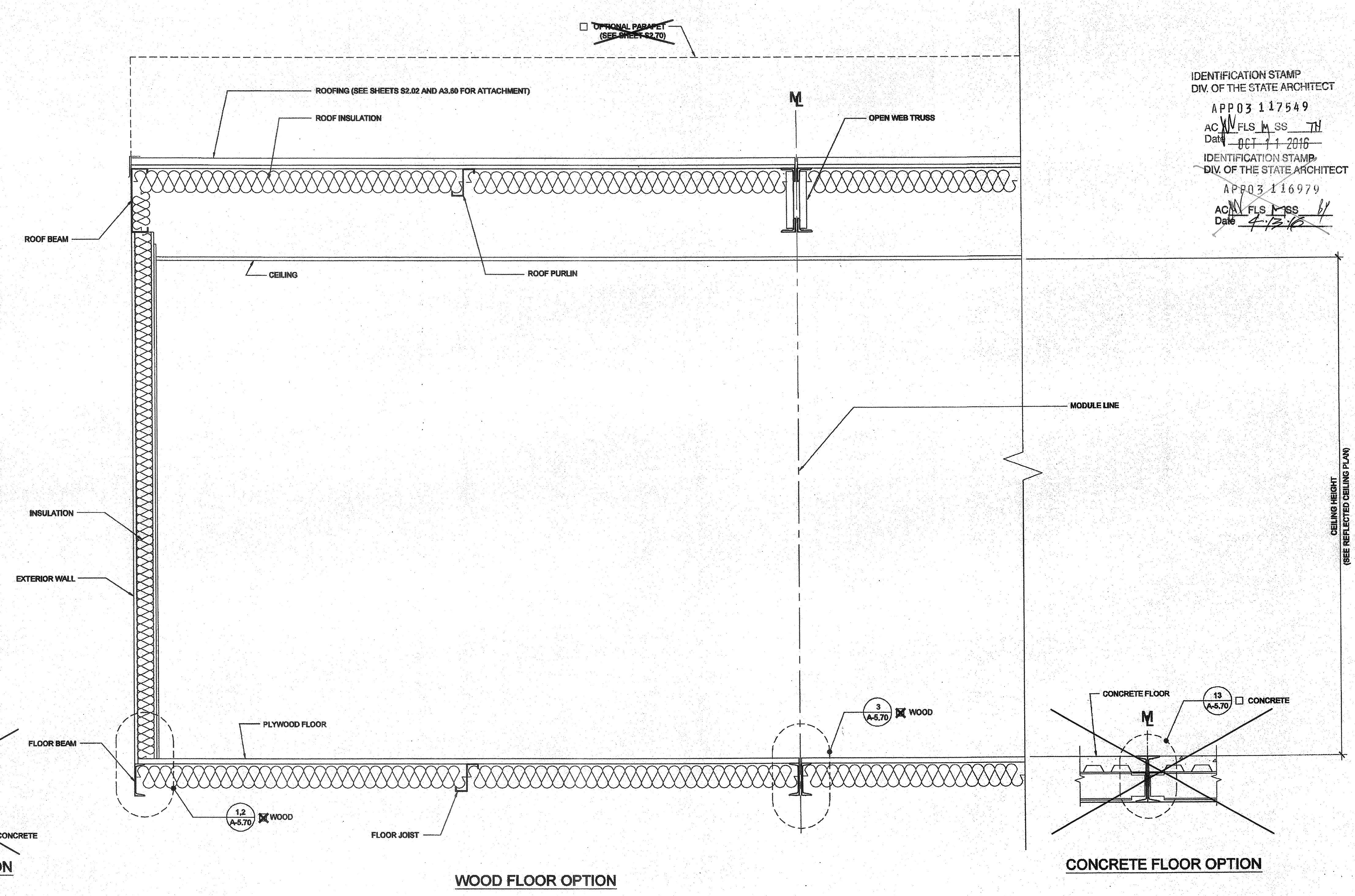

IDENTIFICATION STAMP  
 DIV. OF THE STATE ARCHITECT  
 APP03 117549  
 AC [Signature]  
 DATE OCT 11 2010  
 IDENTIFICATION STAMP  
 DIV. OF THE STATE ARCHITECT  
 APP03 116979  
 AC [Signature]  
 DATE 7-13-10

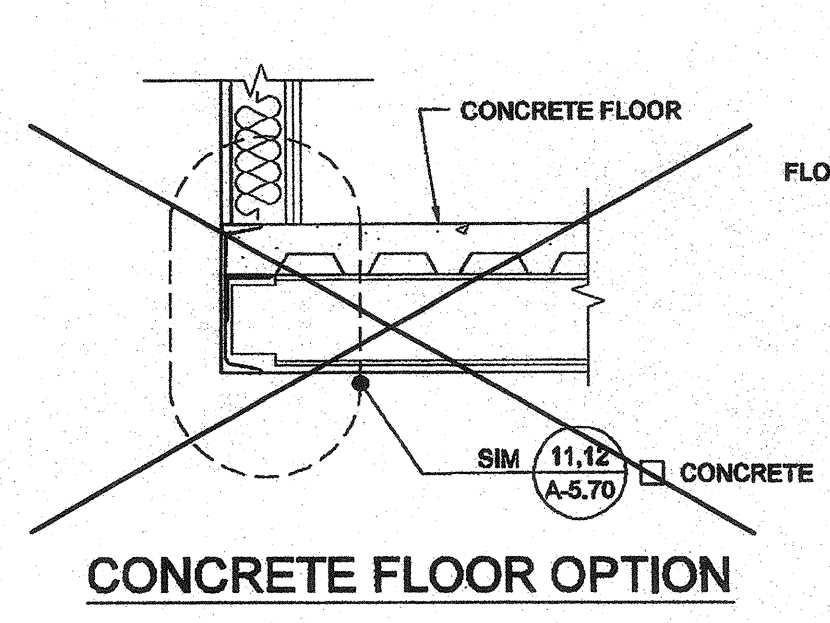

**WOOD FLOOR OPTION**

