

BAKERSFIELD CITY SCHOOL DISTRICT WAYSIDE ELEMENTARY SITE IMPROVEMENTS LANDSCAPE AND IRRIGATION PLANS

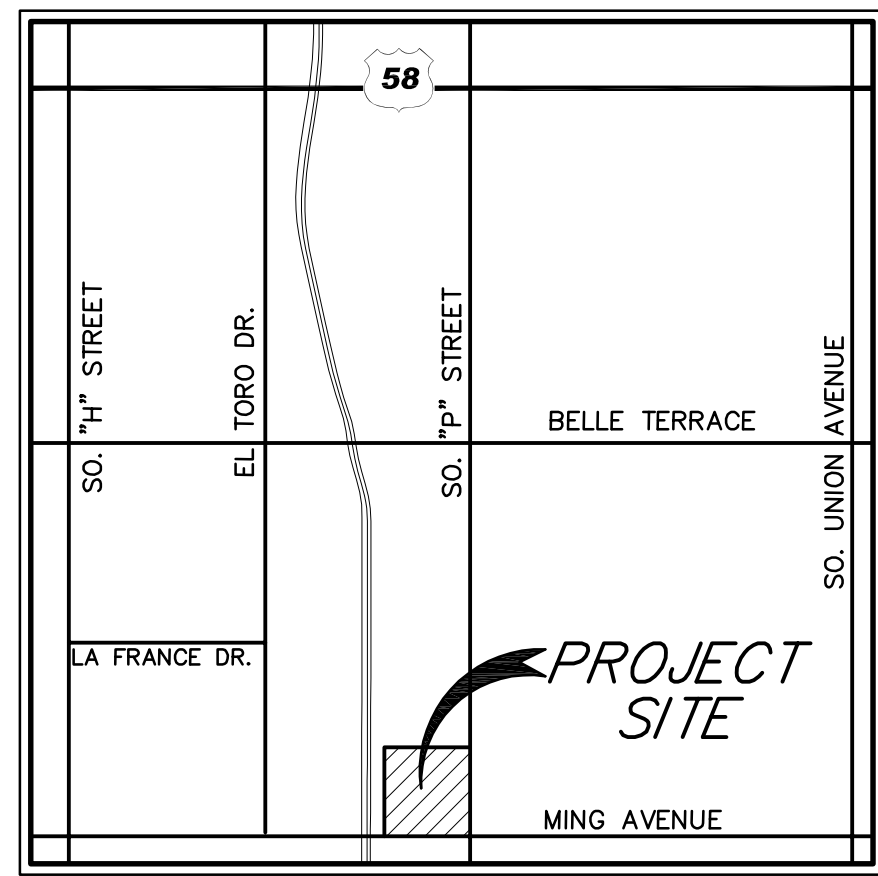

VICINITY MAP
NO SCALE

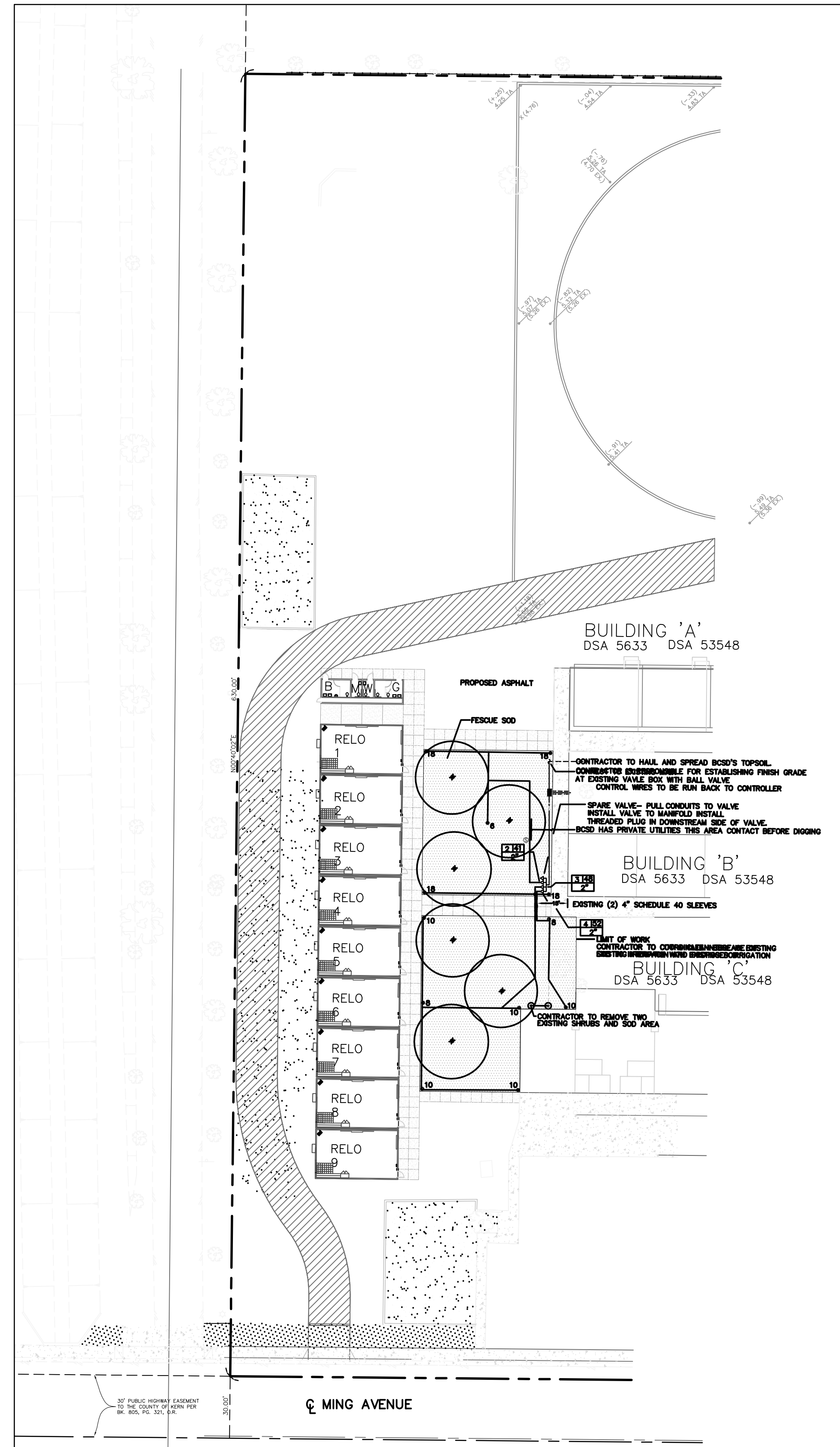

SHEET No. INDEX

- ① COVER SHEET
- ⑪ LANDSCAPING SPECIFICATIONS 1 OF 2
- ⑫ LANDSCAPING SPECIFICATIONS 2 OF 2
- ⑬ IRRIGATION SPECIFICATIONS 1 OF 2
- ⑭ IRRIGATION SPECIFICATIONS 1 OF 2
- ⑨ PLANTING & IRRIGATION DETAILS
- ⑮ LANDSCAPE & IRRIGATION PLAN

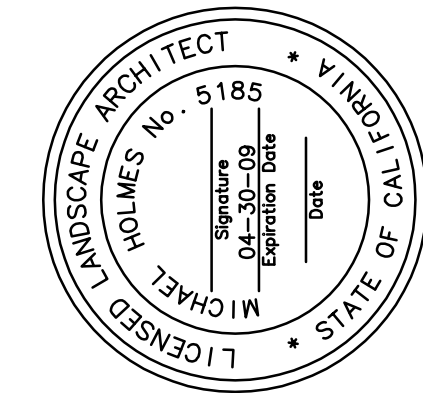

STATISTICS:

1. ASSESSOR'S PARCEL NUMBER: 011-290-20
2. APPROXIMATE ACREAGE: 8.5 AC
3. BUILDING SIZE: APPROXIMATELY 5216 S.F.
4. WATER: EXISTING ON-SITE WATER (CAL WATER)
5. SEWER DISPOSAL: EXISTING ON-SITE SEWER (C.O.B.)
6. DRAINAGE: ON-SITE
7. EXISTING LAND USE: SCHOOL SITE
8. PROPOSED LAND USE: SCHOOL SITE
9. FIRE PROTECTION: C.O.B.
10. ADDRESS: 1000 MING AVENUE
BAKERSFIELD, CA 93307

BENCHMARK USED:

THE SOUTHWEST CORNER OF THE EXISTING SANDBOX NEAR THE EXISTING DRIVEWAY AT MING AVENUE.

ELEVATION = 102.35 TOP OF CONCRETE CURB (ASSUMED)

NOTICE TO CONTRACTORS

- A. THE CONTRACTOR IS REQUIRED TO TAKE DUE PRECAUTIONARY MEASURES TO PROTECT THE UTILITIES OR STRUCTURES SHOWN AND ANY OTHER UTILITIES OR STRUCTURES FOUND AT THE SITE. IT SHALL BE THE CONTRACTORS' RESPONSIBILITY TO NOTIFY THE OWNERS OF THE UTILITIES OR STRUCTURES CONCERNED BEFORE STARTING WORK.
- B. ALL CONTRACTORS AND SUBCONTRACTORS PERFORMING WORK SHOWN ON OR RELATED TO THESE PLANS SHALL CONDUCT THEIR OPERATIONS SO THAT ALL EMPLOYEES ARE PROVIDED A SAFE PLACE TO WORK AND THE PUBLIC IS PROTECTED. ALL CONTRACTORS AND SUBCONTRACTORS SHALL COMPLY WITH THE "OCCUPATIONAL SAFETY AND HEALTH REGULATIONS" OF THE U.S. DEPARTMENT OF LABOR, AND WITH THE STATE OF CALIFORNIA DEPARTMENT OF INDUSTRIAL RELATIONS' "CONSTRUCTION SAFETY ORDERS".
- C. THE LANDSCAPE ARCHITECT SHALL NOT BE RESPONSIBLE IN ANY WAY FOR THE CONTRACTORS' AND SUBCONTRACTORS' COMPLIANCE WITH THE "OCCUPATIONAL SAFETY AND HEALTH REGULATIONS" OF THE U.S. DEPARTMENT OF LABOR OR WITH THE STATE OF CALIFORNIA DEPARTMENT OF INDUSTRIAL RELATIONS' "CONSTRUCTION SAFETY ORDERS".
- D. CONTRACTOR FURTHER AGREES THAT HE SHALL ASSUME SOLE AND COMPLETE RESPONSIBILITY FOR JOB SITE CONDITIONS DURING THE COURSE OF CONSTRUCTION OF THIS PROJECT, INCLUDING SAFETY OF ALL PERSONS AND PROPERTY. THAT THIS REQUIREMENT SHALL APPLY CONTINUOUSLY AND NOT BE LIMITED TO NORMAL WORKING HOURS, AND THAT THE CONTRACTOR SHALL DEFEND, INDEMNIFY AND HOLD THE OWNER AND THE LANDSCAPE ARCHITECT HARMLESS FROM ANY AND ALL LIABILITY, REAL OR ALLEGED, IN CONNECTION WITH THE PERFORMANCE OF WORK ON THIS PROJECT, EXCEPTING FOR LIABILITY ARISING FROM THE SOLE NEGLIGENCE OF THE OWNER OR THE LANDSCAPE ARCHITECT.
- E. THE ESTIMATED QUANTITIES HEREON ARE ONLY FOR THE PURPOSE OF OBTAINING THE NECESSARY PERMITS, AND PINNACLE CIVIL ENGINEERING INC. DOES NOT GUARANTEE THE ACCURACY OF THE ESTIMATED QUANTITIES. THE CONTRACTOR SHALL PERFORM HIS OWN QUANTITY TAKEOFF BEFORE SUBMITTING A BID FOR ANY PORTION OF THE IMPROVEMENTS COVERED BY THESE PLANS.

KEY MAP
SCALE: 1"=40'

CALL: 1-800-227-2600

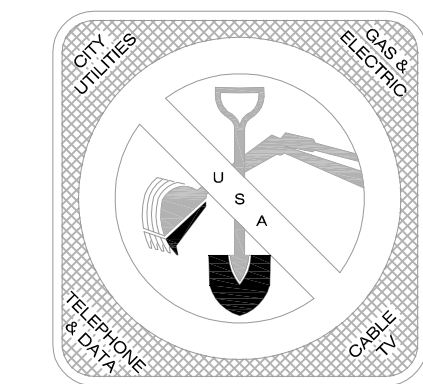

PINNACLE Civil Engineering, Inc.

2161 Saturn Court, Bakersfield, CA 93308
Phone: (661) 869-0184 Fax: (661) 377-0076

MICHAEL HOLMES	LA 5185 EXP. 4/30/09	DATE
REVISIONS	DELETED NORTH PORTION OF SITE	7-14-09
SPECIFIED TREES AND IRRIGATION COMPONENTS		

LANDSCAPE AND IRRIGATION PLANS
BCSD - WAYSIDE ELEMENTARY
IRRIGATION DETAILS
BAKERSFIELD, CALIFORNIA

JOB No.:	07-320
DWG NO.:	07-320GRBM
DATE:	04/07/08
DRAWN BY:	MH
CHECKED BY:	MH
SHEET	1
OF 7 SHEETS	

SECTION 02900

LANDSCAPE FINISH GRADING,
PLANTING, AND ESTABLISHMENT PERIOD

PART 1 GENERAL

1.1 DESCRIPTION

1.1.1
THE GENERAL AND SPECIAL CONDITIONS OF THE CONTRACT APPLY TO THE WORK OF THIS SECTION THE SAME AS THOUGH WRITTEN HEREIN.

1.2 SCOPE OF WORK

1.2.1
THE WORK INCLUDES ALL LABOR, MATERIALS, AND EQUIPMENT TO PERFORM THE WORK HEREIN AND AS REQUIRED TO COMPLETE THE CONTRACT PROPERLY.

1.2.2
THE LANDSCAPE CONTRACTOR SHALL ADEQUATELY PROTECT THE WORK, ADJACENT PROPERTY, AND THE PUBLIC, AND SHALL BE RESPONSIBLE FOR ANY DAMAGE, INJURY, AND LOSS DUE TO HIS ACTS OR NEGLIGENCE. LANDSCAPE CONTRACTOR SHALL CONTINUOUSLY PROTECT AND MAINTAIN ALL AREAS INCLUDED IN THE CONTRACT DURING THE PROGRESS OF THE WORK, THROUGH THE ESTABLISHMENT PERIOD, AND UNTIL FINAL ACCEPTANCE OF THE WORK. LANDSCAPE CONTRACTOR IS RESPONSIBLE FOR ALL REPAIRS OR REPLACEMENTS CAUSED BY ACTS OF VANDALISM, INCLUDING REMOVAL OF GRAFFITI, AND/OR REFINISHING, AS REQUIRED.

1.2.3
THE LANDSCAPE ARCHITECT SHALL BE NOTIFIED OF ANY DISCREPANCIES BETWEEN THE RECOMMENDATIONS ON THE CONTRACT DOCUMENTS AND SITE CONDITIONS.

1.2.4
THE LANDSCAPE CONTRACTOR SHALL EMPLOY ONLY CERTIFIED LANDSCAPE TECHNICIANS (CLT'S) REGISTERED WITH THE CALIFORNIA LANDSCAPE CONTRACTORS ASSOCIATION (CLCA), AS FOREMEN FOR ALL PLANTING INSTALLATION WORK.

1.3 RELATED WORK

1.3.1
SECTION 02811 – IRRIGATION SYSTEM

1.3.2
SECTION 2.10 – TREE ROOT BARRIERS

1.3.3
SECTION 4.1–4.3 – MAINTENANCE PERIOD

1.4 SUBMITTALS, TESTS, AND INSPECTIONS

1.4.1
SUBMIT SAMPLES AND/OR DESCRIPTIVE LITERATURE AND SPECIFICATIONS FOR THE FOLLOWING:

- A. ORGANIC SOIL AMENDMENTS.
- B. PRE-EMERGENT HERBICIDE(S).
- C. ALL INORGANIC SOIL AMENDMENTS, FERTILIZERS, AND CHEMICALS.
- D. ALL PLANT MATERIALS: TREES, SHRUBS, SOD, AND GROUND COVERS
- E. ORGANIC AND INORGANIC MULCH MATERIALS.
- F. HYDRO SEEDING MATERIALS AND SEEDS.
- G. POTTERY AND OTHER LANDSCAPE FURNISHINGS CALLED FOR ON THE DRAWINGS.

1.4.1.2
ANY MATERIALS THAT DIFFER FROM THAT SPECIFIED, WHEN A BRAND NAME IS CALLED FOR ON THE DRAWINGS OR IN THESE SPECIFICATIONS.

1.4.2
LANDSCAPE CONTRACTOR SHALL SUBMIT TO THE LANDSCAPE ARCHITECT PHOTOCOPIES OF CURRENT CLT REGISTRATION FOR ALL FOREMEN PERFORMING WORK ON THIS PROJECT.

1.4.2.1
ANY SAMPLING, TESTING, OR INSPECTION COSTS OF MATERIAL ARE TO BE BORNE BY THE LANDSCAPE CONTRACTOR, AND COPIES OF INSPECTION CERTIFICATES, REQUIRED BY LAW, SHALL BE FURNISHED WITHOUT ADDITIONAL CHARGE.

1.4.2.2
SUBMIT, TO THE OWNER OR THE OWNER'S REPRESENTATIVE, ORIGINAL (NOT PHOTOCOPIED) DELIVERY TICKETS FOR ALL MATERIALS DELIVERED TO THE JOBSITE. IT IS THE RESPONSIBILITY OF THE LANDSCAPE CONTRACTOR TO MAINTAIN COPIES OF TRIP TICKETS FOR HIS USE. THIS REQUIREMENT MUST BE SATISFIED PRIOR TO COMMENCEMENT OF THE ESTABLISHMENT PERIOD.

1.4.3
PLANT MATERIAL 15 GALLON AND LARGER SHALL BE APPROVED AND TAGGED AT THE SOURCE PRIOR TO DELIVERY. WHEN THIS IS NOT PRACTICAL, AND APPROVED BY THE LANDSCAPE ARCHITECT, PHOTOS SHALL BE SUBMITTED FOR APPROVAL. SUBMIT SOURCE FOR ALL 5 GALLON AND SMALLER PLANT MATERIALS, REGARDLESS OF WHICH METHOD IS USED. FINAL APPROVAL OF PLANT MATERIAL SHALL OCCUR AT THE SITE. ANY PLANT MATERIAL THAT IS NOT ACCEPTED SHALL BE IMMEDIATELY REMOVED FROM THE SITE AT LANDSCAPE CONTRACTOR'S EXPENSE.

PART 2 PRODUCTS

2.1 BOXED TREES, CONTAINER TREES, AND OTHER PLANT MATERIAL

2.1.1
NOMENCLATURE: SEE LIST OF PLANT MATERIALS ON LANDSCAPE PLANTING PLAN. PLANT SPECIES' NAMES SHALL BE PER 2003 EDITION OF SUNSET WESTERN GARDEN BOOK. BOTANICAL NAMES SHALL TAKE PRECEDENCE OVER COMMON NAMES.

2.1.2
CONDITIONS: PLANTS SHALL BE SYMMETRICAL, TYPICAL FOR VARIETY AND SPECIES, SOUND, HEALTHY, VIGOROUS, FREE FROM PLANT DISEASE, INSECT PESTS OR THEIR EGGS, EXCESSIVE ABRASIONS OR OTHER OBJECTIONABLE DISFIGUREMENTS, AND SHALL HAVE HEALTHY, NORMAL ROOT SYSTEMS, WELL-FILLING THEIR CONTAINERS, BUT NOT TO THE POINT OF BEING ROOT BOUND. TREE TRUNKS SHALL BE STURDY AND WELL HARDENED-OFF. PLANTS SHALL NOT BE PRUNED PRIOR TO DELIVERY EXCEPT AS AUTHORIZED BY THE LANDSCAPE ARCHITECT.

2.1.3
GROUND-COVER PLANTS (ROOTED CUTTINGS) SHALL HAVE BEEN GROWN IN FLATS AND SHALL REMAIN IN THOSE FLATS UNTIL TIME FOR TRANSPLANTING. AT TIME OF TRANSPLANTING, THE FLAT SOIL SHALL CONTAIN SUFFICIENT MOISTURE AND THE SOIL DOES NOT FALL APART WHEN LIFTING PLANTS FROM FLAT. EACH PLANT SHALL BE PLANTED WITH ITS PROPORTIONATE AMOUNT OF THE FLAT SOIL IN A MANNER THAT WILL ENSURE A MINIMUM OF DISTURBANCE TO THE ROOT SYSTEM. PLANTS SHALL BE FULLY DEVELOPED AND HARDENED OFF AND SHALL BE FILLING THE FLAT.

2.1.4
IN NO CASE SHALL TREES OR SHRUBS BE TOPPED OR PRUNED WITHIN 6 MONTHS PRIOR TO DELIVERY. PLANTS SHALL BE GROWN IN NURSERIES THAT HAVE BEEN INSPECTED BY THE STATE DEPARTMENT OF AGRICULTURE AND HAVE COMPLIED WITH ITS REGULATIONS.

2.1.5
IDENTIFICATION: PLANTS SHALL BE OF THE VARIETY AND SIZE SHOWN ON THE DRAWINGS, AND SHALL CONFORM TO THE REQUIREMENTS HEREIN. ONE OF EACH BUNDLE OR LOT SHALL BE TAGGED WITH PLANT NAME IN ACCORDANCE WITH RECOMMENDATIONS OF THE AMERICAN ASSOCIATION OF NURSERYMEN.

2.1.6
SUBSTITUTIONS: THE LANDSCAPE CONTRACTOR SHALL NOT SUBSTITUTE ANY PLANT MATERIAL WITHOUT AUTHORIZATION BY THE LANDSCAPE ARCHITECT. WITHIN 10 CALENDAR DAYS OF NOTICE TO PROCEED, LANDSCAPE CONTRACTOR SHALL SUBMIT COPIES OF ALL PAPERWORK TO THE LANDSCAPE ARCHITECT STATING LOCATION OF PLANT MATERIAL TO BE PURCHASED AND TO BE INSTALLED ON THIS PROJECT. WORK SHALL NOT PROCEED WITHOUT RECEIPT OF THIS PAPERWORK. SUBSTITUTIONS FOR THE INDICATED PLANT MATERIALS WILL BE PERMITTED PROVIDED THE

LANDSCAPE CONTRACTOR BEING AWARDED THE PROJECT NOTIFIED THE LANDSCAPE ARCHITECT OF LACK OF AVAILABILITY DURING THE BIDDING PROCESS. THE LANDSCAPE ARCHITECT MAY ALLOW THE REQUESTED SUBSTITUTIONS AS LONG AS THE SUBSTITUTIONS ARE MADE AT NO ADDITIONAL COST TO THE OWNER, EXCEPT FOR THE VARIATIONS SO AUTHORIZED, SUBSTITUTED PLANT MATERIALS SHALL CONFORM TO THE REQUIREMENTS OF THESE SPECIFICATIONS. IF ACCEPTED SUBSTITUTE MATERIALS ARE LESS VALUE THAN THOSE INDICATED OR SPECIFIED, THE CONTRACT PRICE WILL BE ADJUSTED IN ACCORDANCE WITH THE PROVISIONS OF THE CONTRACT. SHOULD THE LANDSCAPE CONTRACTOR FAIL TO PROCURE THE REQUIRED PLANT MATERIAL CALLED FOR IN THE DRAWINGS AFTER SUBMITTING THE PAPERWORK CALLED FOR ABOVE INDICATING THE PLANT MATERIAL WAS AVAILABLE AND SET ASIDE FOR THIS PROJECT, THE LANDSCAPE CONTRACTOR SHALL INSTALL THE NEXT SIZE UP AT NO ADDITIONAL COST TO THE OWNER.

2.1.7
CONTAINER PLANT INSPECTION AND REJECTION: ROOT CONDITION OF CONTAINER PLANTS WILL BE DETERMINED BY THE LANDSCAPE ARCHITECT THROUGH THE REMOVAL OF PLANTS FROM THEIR CONTAINERS OF AT LEAST TWO PLANTS BUT NOT MORE THAN 2% OF THE TOTAL NUMBER EACH SPECIES FROM EACH SOURCE AND EACH SIZE.

2.1.8
LANDSCAPE ARCHITECT WILL INSPECT TREES UPON DELIVERY. TREES AND/OR SHRUBS WILL BE REJECTED IF ANY ONE OF THE FOLLOWING CHARACTERISTICS ARE PRESENT:

- A. ENLARGED CANKERS OR GALLS AT THE BASE OF THE TRUNK, JUST ABOVE THE SOIL LEVEL.
- B. CROOKED TRUNKS.
- C. SCARS OR TRUNK DAMAGE, BROKEN BRANCHES, ETC.

D. ASYMMETRICAL BRANCHING.

E. ROOT BOUND CONDITION.

F. ANY TREES THAT HAVE BEEN RECENTLY PRUNED BACK.

2.1.8.1
ALL TREES SHALL BE MATCHING IN SIZE AND SHAPE.

2.1.9
QUANTITIES: IN ALL CASES, PLANT MATERIAL SHALL BE FURNISHED AS NEEDED TO COMPLETE WORK AS INDICATED ON THE DRAWINGS, INCLUDING RESEEDING, REPLANTING, AND MAINTENANCE (REPLACEMENTS) DURING THE CONTRACT PERIOD. LANDSCAPE ARCHITECT IS NOT RESPONSIBLE FOR PLANT QUANTITIES SHOWN.

2.1.10
SIZES AND CALIPER: MINIMUM HEIGHT (ABOVE SOIL LEVEL), WIDTH (AVERAGE DIAMETER OF DRIP LINE), AND CALIPER (TREES ONLY, MEASURED AT 30" ABOVE THE SOIL LEVEL) OF PLANT MATERIALS SHALL BE AS NOTED IN THE LEGEND.

2.1.11 N/A

2.1.12
ALL PLANT MATERIAL SHALL BE ACCLIMATED TO THE SITE PRIOR TO DELIVERY TO THE SITE. DAMAGE OF ANY PLANT MATERIAL DUE TO THE LANDSCAPE CONTRACTOR'S FAILURE TO INSURE SUCH ACCLIMATIZATION SHALL BE REPLACED AT NO COST TO THE OWNER.

2.2 SOIL AMENDMENTS

2.2.1
ALL AREAS TO BE PLANTED AND IRRIGATED SHALL RECEIVE SOIL AMENDMENTS, EXCEPT WHERE SPECIFICALLY NOTED OTHERWISE ON THE DRAWINGS.

2.2.2
THE FOLLOWING SOIL AMENDMENTS ARE TO BE USED AS THE BASIS FOR BIDS. ONCE ALL SITE IMPROVEMENTS ARE IN PLACE AND APPROXIMATE FINISH GRADES ESTABLISHED, THE LANDSCAPE CONTRACTOR SHALL FURNISH TO THE LANDSCAPE ARCHITECT A SOILS REPORT MADE FROM THE SURFACE AND SUBSURFACE (18" BELOW GRADE) SOIL BY AN APPROVED AGRICULTURAL LAB. THE REPORT SHALL INCLUDE PH, N-P-K, SAR, ECE, BORON LEVELS, AND SOIL PARTICLE SIZE AND TEXTURAL EVALUATION. LANDSCAPE ARCHITECT SHALL REVIEW THIS REPORT PRIOR TO COMMENCEMENT OF SOIL PREPARATION OR PLANTING, AND RECOMMEND ADJUSTMENTS TO THE LANDSCAPE CONTRACTOR, IF REQUIRED. LOCATIONS OF SOIL TESTING SHALL BE APPROVED BY THE LANDSCAPE ARCHITECT IN THE FIELD. A MINIMUM OF 5 (FIVE) SUCH TESTS SHALL BE PERFORMED BY THE LANDSCAPE CONTRACTOR.

2.2.2.1
SOIL PREPARATION FOR TURF AREAS, AMOUNT PER 1000 SQUARE FEET:

3 CU. YDS. SEA-SOIL, COMPOSTED KELP ORGANIC AMENDMENT (AVAILABLE FROM BUTLER'S MILL, SAN DIEGO, CA, (619)) OR APPROVED EQUAL

75 LBS. Tri-C HUMATE PLUS

25 LBS. 16-6-8 GRANULAR FERTILIZER

100 LBS. AGRICULTURAL GYPSUM

10 LBS. SOIL SULFUR

2.2.2.2
GENERAL SOIL PREPARATION FOR AREAS WHICH ARE LESS THAN 2:1 SLOPE ASPECT RATIO, AMOUNT PER 1000 SQUARE FEET:

4 CU. YDS. COMPOSTED ORGANIC SOIL AMENDMENT (PER SECTION 2.2.3).

75 LBS. HUMATE PLUS, (AVAILABLE FROM TRI-C ENTERPRISES, CHINO, CA, (800) 927-3311)

25 LBS. 16-6-8 GRANULAR FERTILIZER

100 LBS. AGRICULTURAL GYPSUM

10 LBS. SOIL SULFUR

2.2.2.3 N/A

2.2.3 COMPOSTED ORGANIC SOIL AMENDMENT

2.2.3.1
SHALL BE RECYC COMPOST SOIL CONDITIONER (AVAILABLE FROM RECYC, INC. 114 BUSINESS CENTER DRIVE, CORONA, CA 91720-1724, (919) 71-3929), OR APPROVED EQUAL.

OR
SHALL BE EARTHWISE ECO-HUMUS SOIL AMENDMENT (AVAILABLE FROM A.J. ECOLOGY INDUSTRIES, INC., RANCHO SANTA FE, CA, (619) 744-0942), OR APPROVED EQUAL.

2.2.3.2
PRODUCT SHALL CONSIST OF A BLEND OF SEWAGE SLUDGE, RECYCLED GARDEN WASTE, AND WOOD BY-PRODUCTS. IT SHALL BE PROPERLY CURED FOR A MINIMUM OF 150 DAYS, AND BE FREE FROM ANY TRASH, DELETERIOUS MATERIALS, AND/OR TOXIC CHEMICALS. PRODUCT SHALL BE NON-HAZARDOUS, AND CONFORM WITH US ENVIRONMENTAL PROTECTION AGENCY 40 CFR 503 CRITERIA FOR "CLASS A" PRODUCT. IT SHALL EXCEED STANDARDS AND SPECIFICATIONS FOR UNRESTRICTED APPLICATION AS A LANDSCAPING AND AGRICULTURAL SOIL AMENDMENT.

2.2.3.3
PRODUCT SHALL BE RICH FULLY COMPOSTED 100 % RECYCLED ORGANIC PRODUCT CONSISTING OF 35% DIGESTED, CENTRIFUGED, COMPOSTED BIO-SOLIDS PRODUCT, AND 65 % AGED WOOD FIBERS.

- TOTAL NITROGEN 0.50%
- (1) ORGANIC N 0.40%
- (2) AMMONIUM / N 0.09%
- (3) NITRATE N 0.01%
- PHOSPHORUS (AS P2O5) 8,684PPM
- POTASSIUM (AS K2O) 5,485PPM
- CALCIUM 25,283PPM
- COPPER 195PPM
- IRON 17,562PPM
- MAGNESIUM 4,413PPM
- MANGANESE 283PPM
- SULFUR 4,927PPM
- ZINC 362PPM
- BORON LESS THAN 1.00PPM
- CARBON TO NITROGEN RATIO 20:01
- ORGANIC MATTER (DRY WT BASIS) 40%
- ECE LESS THAN 10.50 MMHOS/CMPH RANGE 7.2-7.8
- MOISTURE CONTENT 45-50%
- BULK DENSITY 1,100 LBS. PER CU. YD.

2.2.3.4
FOR EACH PRODUCT TO BE USED, LANDSCAPE CONTRACTOR SHALL SUBMIT A SAMPLE AND SPECIFICATION SHEET, INCLUDING PARTICLE SIZE EVALUATION, TOTAL N (NITROGEN), NH4-N (AMMONIA), NO3-N (NITRATE), ECE, PH, MICRO NUTRIENTS, AND METALS. GUARANTEED ANALYSIS SHALL CONFORM TO THE FOLLOWING, WITH A ± 10% VARIANCE ALLOWABLE.

2.2.3.5
PARTICLE SIZE SHALL BE 100 % PASSING A 1/2" SCREEN.

2.2.4
THE LANDSCAPE CONTRACTOR IS RESPONSIBLE FOR CORRECTION OF SOIL PH, NUTRIENT LEVELS, AND CHEMICAL BALANCE UNTIL FINAL ACCEPTANCE BY THE OWNER. THE LANDSCAPE CONTRACTOR SHALL TAKE SOIL SAMPLES FROM FIVE SEPARATE LOCATIONS AS DIRECTED BY THE LANDSCAPE ARCHITECT, AND PREPARE SOILS REPORTS BY A TESTING SERVICE APPROVED BY THE LANDSCAPE ARCHITECT. PREPARE SOILS REPORTS BEFORE PREPARING SOIL, AT THE START OF THE ESTABLISHMENT PERIOD, ON THE 45TH DAY OF ESTABLISHMENT PERIOD, AND ON THE 80TH DAY OF ESTABLISHMENT PERIOD. CORRECT ANY DEFICIENCIES IDENTIFIED AT TESTING INTERVALS BY AMENDING OR TOP DRESSING AS REQUIRED, AT NO ADDITIONAL COST TO THE OWNER.

2.3 SOD

2.3.1
SOD SHALL BE AS SPECIFIED IN DRAWINGS.

2.3.2
SOD SHALL BE MACHINE CUT AT A UNIFORM SOIL THICKNESS OF 5/8" PLUS OR MINUS 1/4". MEASUREMENTS FOR THICKNESS SHALL EXCLUDE TOP GROWTH AND THATCH. INDIVIDUAL PIECES OF SOD SHALL BE CUT TO THE SUPPLIER'S STANDARD WIDTH AND LENGTH. MAXIMUM ALLOWABLE DEVIATION FROM STANDARD WIDTH AND LENGTHS SHALL BE 2% BROKEN ROLLS OR SLABS AND TORN OR UNEVEN ENDS WILL NOT BE ACCEPTABLE. STANDARD SIZE SECTIONS OF SOD SHALL BE STRONG ENOUGH TO SUPPORT THEIR OWN WEIGHT AND RETAIN THEIR SIZE AND SHAPE WHEN SUSPENDED VERTICALLY FROM A FIRM GRASP ON THE UPPER 10% OF THE SECTION.

2.3.3
INSTALL SOD GREEN SIDE UP.

2.4 ARTIFICIAL TURF

2.4.1 N/A

2.4.2 N/A

2.4.3 N/A

2.5 N/A

2.5.1 N/A

2.6 HEADER MATERIAL

2.6.1
CONCRETE HEADERS AND MOW CURBS SHALL BE INSTALLED ACCORDING TO THE DETAILS AND IN STRICT ADHERENCE TO THE DIMENSIONING PLAN. FORMS FOR THE ABOVE SHALL BE STAKED AT 4 FEET MAXIMUM INTERVALS AND ALL FORMING SHALL BE APPROVED IN THE FIELD BY THE LANDSCAPE ARCHITECT PRIOR TO POURING CONCRETE. MOW CURBS MAY BE EXTRUDED IF THE LANDSCAPE ARCHITECT APPROVES SUCH METHODS IN ADVANCE.

2.6.2
FORMING STAKES SHALL BE AT LEAST ONE INCH BY TWO INCHES ACTUAL DIMENSIONS, OF LENGTH NECESSARY TO EXTEND INTO SOLID EARTH A MINIMUM OF TWELVE (12) INCHES.

2.7 TREE STAKES

2.7.1
TREE STAKES SHALL BE 2" IN DIAMETER BY 8' OR 10' LONG NEW PINE LODGE POLES TREATED WITH COPPER NAPHTHENATE, PER DETAILS.

2.7.2
TREE STAKES FOR 30" BOX OR LARGER TREES SHALL BE 3" IN DIAMETER.

2.8 TIES

2.8.1
TREE TIES SHALL BE "INCH-TIE" AS MANUFACTURED BY V.I.T. PRODUCTS, ESCONDIDO, CA (800) 729-1314, OR APPROVED EQUAL.

2.8.2
USE 30" LONG TIES FOR 5 & 15 GALLON TREES, 36" LONG FOR 24" BOX AND LARGER.

2.8.3
USE 1-1/4" OR 1-1/2" LONG GALVANIZED ROOFING NAILS TO SECURE TIES.

2.8.4
ESPALIER TO WOOD SURFACE: GALVANIZED 1" STAPLE AND 1/2" WIDE "TYE-ALL" TIE.

2.8.5
ESPALIER TO CONCRETE OR STUCCO SURFACE: 7/8" DIAMETER ALUMINUM FLAT WASHER OR CLEAR PLASTIC "BUTTON" WITH WIRE HOOK SECURED TO SURFACE WITH G.E. CLEAR SILICONE RUBBER AND 1/2" WIDE "TYE-ALL" TIE.

2.9 TREE GUYING MATERIALS

2.9.1
ANCHORS SHALL BE DUCKBILL, EARTH ANCHOR SYSTEMS, AS MANUFACTURED BY FORESIGHT PRODUCTS, INC., OR APPROVED EQUAL. CABLE SHALL BE NON-COATED, STAINLESS STEEL BRAIDED CABLE, SIZED PER MANUFACTURER'S RECOMMENDATIONS.

2.9.2
ANCHOR
3.3 AND CABLE SIZING SHALL BE PER THE FOLLOWING SCHEDULE: TREE CALIPER ANCHOR CABLE SIZE RATED CAPACITY UP TO 3", USE A #40 AND 1/16th INCH CABLE WITH A RATED CAPACITY OF *300 LBS. 3" TO 6", USE A #68 AND 1/8th INCH CABLE AND WITH A RATED CAPACITY OF 1,100 LBS. 6" TO 11", USE A #88 AND 3/16th INCH CABLE AND WITH A RATED CAPACITY OF 3,000 LBS.

2.9.3
HOSE CABLE GUARDS SHALL BE NEW 5/8" RUBBER, BROWN OR RED.

2.9.4
CABLE SLEEVES SHALL BE NEW 1/2" WHITE SCHEDULE 40 PVC PIPE. CUT TO LENGTH PROVIDED BY MANUFACTURERS RECOMMENDATIONS.

2.9.5
CABLE CLAMPS SHALL BE HOT DIP GALVANIZED. WEDGED FITTINGS ARE NOT ALLOWED, EXCEPT AT ANCHOR.

2.10 ROOT BARRIERS

2.10.1
ROOT BARRIERS SHALL BE AS CALLED FOR ON PLANS AND DETAILS.

2.10.2
THE CONTRACTOR SHALL FURNISH AND INSTALL TREE ROOT BARRIERS AS SPECIFIED. THE TREE ROOT BARRIERS SHALL BE PRODUCT # UB 18-2 AS MANUFACTURED BY DEEP ROOT PARTNERS, L.P., 81 LANGTON ST. #4, SAN FRANCISCO, CA (800-458-7668), OR APPROVED EQUAL. THE BARRIER SHALL BE BLACK, INJECTION MOLDED PANELS, OF .080" (2.03MM) WALL THICKNESS IN MODULES 24" (61CM) LONG BY 18" (46CM) DEEP; MANUFACTURED WITH A MINIMUM 50% POST CONSUMER RECYCLED POLYPROPYLENE PLASTIC WITH ADDED ULTRAVIOLET INHIBITORS; RECYCLABLE.

EACH PANEL SHALL HAVE: NOT LESS THAN 4 MOLDED INTEGRAL VERTICAL ROOT DEFLECTING RIBS OF AT LEAST 0.06"(1.52MM) THICKNESS PROTRUDING 1/2"(12.7MM) AT 90° FROM INTERIOR OF THE BARRIER PANEL, SPACED 6"(15.24MM) APART.

A DOUBLE TOP EDGE CONSISTING OF TWO PARALLEL, INTEGRAL, HORIZONTAL RIBS AT THE TOP OF THE PANEL OF A MINIMUM 0.06"(1.52MM) THICKNESS 3/8"(9.53MM) WIDE AND 1/4"(6.35MM) APART WITH THE LOWER RIB ATTACHED TO THE VERTICAL ROOT DEFLECTING RIBS.

A MINIMUM OF 9 ANTI-LIFT GROUND LOCK TABS CONSISTING OF INTEGRAL HORIZONTAL RIDGES OF A MINIMUM 0.06"(1.52MM) THICKNESS IN THE SHAPE OF A SEGMENT OF A CIRCLE, THE 2 1/4"(57MM) CHORD OF THE SEGMENT JOINING THE PANEL WALL AND THE SEGMENT, PROTRUDING 3/8" (9.53MM) FROM THE PANEL. THE NINE GROUND LOCKS ON EACH PANEL SHALL BE ABOUT EQUALLY SPACED BETWEEN EACH OF THE VERTICAL ROOT DEFLECTING RIBS (3 BETWEEN EACH SET OF RIBS, SEE MANUFACTURERS SPECIFICATIONS).

AN INTEGRATED ZIPPER JOINING SYSTEM PROVIDING FOR INSTANT ASSEMBLY BY SLIDING ONE PANEL INTO ANOTHER.

2.11 IMPORT SOIL OR TOPSOIL

2.11.1
IMPORT SOIL SHALL BE CLASS A TOPSOIL NATURAL, FRIABLE, WELL-DRAINING SOIL. PROVIDE SOIL FREE FROM SUBSOIL, BRUSH, OBJECTIONABLE WEEDS, SEEDS, ROCKS, ORGANIC OR INORGANIC DEBRIS, SILT, AND CLAY. THE SOIL SHALL BE FREE OF ANY TOXIC SUBSTANCE, ORGANIC OR INORGANIC, SOIL STERILANTS, SALTS, AND NO SOIL REMOVED FROM ROAD BED EXCAVATIONS.

2.11.2
THE LANDSCAPE CONTRACTOR SHALL FURNISH, UPON THE REQUEST OF THE LANDSCAPE ARCHITECT, A SOILS REPORT MADE FROM THE INTENDED IMPORT BY AN APPROVED AGRICULTURAL LAB. THE REPORT SHALL INCLUDE PH, N-P-K, SAR, MINERALS, MICRO-NUTRIENTS, ECE, BORON LEVELS, SOIL PARTICLE SIZE, AND TEXTURAL ELEVATION. SOIL IMPORTED TO SITE AND FOUND TO BE UNSUITABLE BY THE LANDSCAPE ARCHITECT SHALL BE REMOVED FROM THE SITE AND REPLACED WITH AN APPROVED SOIL AT THE LANDSCAPE CONTRACTOR'S EXPENSE. THE LANDSCAPE CONTRACTOR SHALL PAY ALL EXPENSES FOR SOIL TESTING OF IMPORT MATERIALS.

2.12
LIGHT WEIGHT SOIL FOR PLANTERS AND POTS

2.12.1
A-1-87 LIGHTWEIGHT SOIL, A LIGHTWEIGHT SOIL MIXTURE, AVAILABLE AT A-1 SOILS, SAN DIEGO, (619) 566-2000, OR EQUIVALENT. SOIL BLEND OF THE FOLLOWING COMPOSITION SHALL BE USED FOR IMPORT SOIL TO FILL RAISED PLANTERS AND POTS. SOIL SHALL BE PREMIXED BY MACHINE BLENDER PRIOR TO DELIVERY TO SITE: PH 6.8 - 7.2 ECE 1.7 - 2.0 MMHOS/CM BULK DENSITY (AT SATURATION) 86 LBS/CU. FT.

2.12.2
THE COMPONENTS OF THIS MIXTURE SHALL BE LONG-LASTING, THEREBY MINIMIZING UNDESIRABLE SHRINKAGE AND SETTLING WHICH ARE OFTEN FOUND WITH PRODUCTS CONTAINING RAPIDLY DECOMPOSING COMPONENTS.

2.12.3
THE MIX SHALL CONTAIN A LONG-LASTING FORM OF IRON AND A NON-IONIC WETTING AGENT.

2.13
ORGANIC MULCH MATERIAL

2.13.1
SHALL BE AS SPECIFIED IN DRAWINGS. CONTRACTOR TO PROVIDE 1 CU. FT. SAMPLE, NAME, AND CONTACT INFORMATION TO LANDSCAPE ARCHITECT FOR APPROVAL.

2.13.2
MULCH SHALL CONSIST OF 100% RECYCLED ABOVE GROUND TREE PRODUCTS. MULCH SHALL CONTAIN NO DEMOLITION WOOD WASTE, GRASS, WEED SEED, YUCCA, PALM, BAMBOO, OR OTHER SUCULENTS OR CONTAMINANTS. MULCH SHALL BE NITROGEN STABILIZED AND SHALL CONTAIN NO TRASH, HAZARDOUS WASTE, OR TOXIC MATERIALS.

2.13.3
MULCH SHALL BE GROUND AND SCREENED TO PRODUCE A 3/8" TO 3" PARTICLE SIZE.

2.14
PRE-EMERGENT HERBICIDE (SHRUB AND PLANTED GROUND COVER AREAS ONLY)

2.14.1
PRE-EMERGENT HERBICIDES SHALL BE WETTABLE POWDER OR GRANULAR TYPE.

2.14.2
SELECT PRE-EMERGENT HERBICIDE APPROPRIATE TO SITE AREA, SOIL TYPE, INDIGENOUS WEEDS TO BE CONTROLLED, AND TYPE OF GROUND COVER TO BE PLANTED.

2.14.3
DO NOT USE PRE-EMERGENT HERBICIDES IN AREAS TO BE HYDROSEEDED OR STOLONIZED.

2.14.4
FOLLOW ALL MANUFACTURER'S PRECAUTIONS AND LABEL INSTRUCTIONS. COMPLY WITH ALL LOCAL JURISDICTIONAL RESTRICTIONS AND ORDINANCES.

2.15
TRI-C MYCO PAKS

2.15.1
PAKS SHALL BE "TRI-C MYCO" AS DISTRIBUTED BY TRI-C ENTERPRISES, LLC @ 800-927-3311

2.15.2
TRI-C MYCO PAKS 7 GRAM

PART 3 EXECUTION

3.1 SCHEDULING

3.1.1 INSPECTION

3.1.1.1
PRIOR TO WORK OF THIS SECTION, CAREFULLY INSPECT PREVIOUSLY INSTALLED WORK. VERIFY ALL SUCH WORK IS COMPLETE TO THE POINT WHERE THIS INSTALLATION MAY PROPERLY COMMENCE.

3.1.1.2
VERIFY THAT WORK OF THIS SECTION MAY BE INSTALLED IN STRICT ACCORDANCE WITH THE ORIGINAL DESIGN, ALL PERTINENT CODES AND REGULATIONS, AND ALL PERTINENT PORTIONS OF THE REFERENCED STANDARDS.

3.1.1.3
DO NOT PROCEED WITH INSTALLATION IN AREAS OF DISCREPANCY UNTIL ALL SUCH DISCREPANCIES HAVE BEEN FULLY RESOLVED.

3.1.2
PLANTING OPERATIONS SHALL NOT COMMENCE UNTIL COMPLETION OF ALL CONSTRUCTION WORK, GRADING, SOIL PREPARATION, WEED CONTROL, AND SPRINKLER INSTALLATION.

3.2 SOIL PREPARATION

3.2.1
FOR AREAS TO RECEIVE HYDROSEEDING, SOD, STOLONS, OR FLATTED GROUNDCOVERS ONLY: IRRIGATE SITE NORMALLY FOR TWO WEEKS TO GERMINATE WEEDS. APPLY CONTACT HERBICIDE PER MANUFACTURER. REPEAT PROCESS IF REQUIRED BY LANDSCAPE ARCHITECT.

3.2.2
RIP IN TWO DIRECTIONS, ALL AREAS TO RECEIVE SOIL AMENDMENTS TO A MINIMUM DEPTH OF 12 INCHES. ROTOTILL TOP 6" OF SOIL TO A LOOSE AND FRIABLE CONSISTENCY. APPLY SOIL AMENDMENTS AS SPECIFIED, EVENLY AND AT THE SPECIFIED APPLICATION RATES.

3.2.3
FINISH GRADE TO CONTOURS AND SPOT ELEVATIONS SHOWN ON DRAWINGS.

3.2.4
AT TIME OF PLANTING, TOP 3" OF SOIL IN ALL AREAS TO BE PLANTED OR SEEDDED SHALL BE FREE OF STONES, STUMPS, ROOTS, OR OTHER DELETERIOUS MATTER 1" IN DIAMETER OR LARGER AND SHALL BE FREE FROM ALL WIRE, PLASTER, OR SIMILAR OBJECTS THAT WOULD BE A POTENTIAL HAZARD OR HINDRANCE TO PLANTING OR MAINTENANCE.

3.3 LANDSCAPE FINISH GRADING

3.3.1
FINISH GRADING AFTER SOIL PREPARATION SHALL ESTABLISH FINAL FLOW LINES AND GRADIENTS FOR UNIFORM WATER

3.3.2
FINISH GRADE FOR ALL LAWN AREAS SHALL BE 1" BELOW SIDEWALKS AND CURBS, EXCEPT AT LOCATIONS WHERE DRAINAGE WATER WILL FLOW ONTO OR ACROSS HARDCAPE, CURBS, OR PAVING. AT THESE CONDITIONS, THE GRADE SHALL BE FLUSH OR NO MORE THAN 1/2" BELOW HARDCAPING. FINISHED GRADES SHALL BE OF UNIFORM SLOPE AND GRADE BETWEEN POINTS OF FIXED ELEVATIONS OR ELEVATION CONTROLS. FINISH GRADES SHALL BE ESTABLISHED FROM SUCH POINTS.

3.3.3
ALL FINISH GRADES SHALL BE FLOATED TO ASSURE A UNIFORM SURFACE WITHOUT IRREGULAR DIPS OR RIDGES. ALL TURF AREAS SHALL BE FLOATED WITH A MINIMUM 4' WIDE FLOAT AND GRADED AWAY FROM THE ESTABLISHED FLOWLINE. ROLL ALL TURF AREAS AND REFLOAT TO ELIMINATE DEPRESSIONS.

3.3.4
LANDSCAPE CONTRACTOR SHALL BE RESPONSIBLE FOR BRINGING ALL SHRUB PLANTING AREAS TO FINISH GRADE AFTER SOIL PREPARATION WHICH SHALL BE 2" BELOW PAVING AND CURBS OR AS NOTED BY SPOT ELEVATIONS. SPECIAL ATTENTION SHALL BE GIVEN TO MAINTAINING CONTINUOUS AND EVEN FLOW LINES, AND DRAINAGE AWAY FROM STRUCTURES, TO DRAIN INLET OR OUTLET. GRADES SHALL BE ESTABLISHED TO DRAIN ALL WATER AWAY FROM STRUCTURES BEHIND WALLS. WHEN DRAINAGE IS DIFFICULT TO ACHIEVE, THE LANDSCAPE CONTRACTOR SHALL NOTIFY THE LANDSCAPE ARCHITECT AND REQUEST A SOLUTION BEFORE CONTINUING. GRADES IN SHRUB AREAS SHALL BE ESTABLISHED PRIOR TO PLANTING TO ENSURE PROPER FINAL PLANTING HEIGHTS.

3.3.5
ALL FILL AREAS AND CONSTRUCTED BERMS OR MOUNDS SHALL BE COMPACTED IN EVEN LEVELS TO COMPACTION AS SPECIFIED IN THE GEOTECHNICAL REPORT.

3.4 SPACING / LOCATION OF PLANT MATERIALS

3.4.1
WHEN PLANT MATERIAL IS SPACED IN ROWS, THE TOTAL DIMENSION SHALL BE VERIFIED AND THE PLANTS EQUALLY SPACED WITHIN THE DESIGNATED AREA. WHEN PLANT MATERIAL IS SHOWN IN A LOOSE PATTERN, THE LANDSCAPE CONTRACTOR SHALL SPACE THE MATERIAL AS SHOWN ON DRAWINGS AND AS DIRECTED BY LANDSCAPE ARCHITECT. GROUND COVER MATERIAL SHALL BE TRIANGULARLY SPACED PER DIMENSION INDICATED ON DRAWINGS (WHERE APPLICABLE.)

3.4.2
ALL BOXED AND CONTAINER STOCK SHALL BE SPOTTED ON-SITE BY THE LANDSCAPE CONTRACTOR PER DRAWINGS PRIOR TO PLANTING. PLANT PITS SHALL NOT BE EXCAVATED UNTIL THE REVIEW OF PLANT LOCATIONS BY THE LANDSCAPE ARCHITECT.

3.4.3
THE WORK SHOWN ON PLANTING PLANS IS SCHEMATIC. ALL ITEMS, I.E. TREES, SHRUBS, GROUNDCOVERS, ETC., ARE SHOWN IN THEIR APPROXIMATE LOCATIONS ONLY. DETAIL DRAWINGS MAY PROVIDE ADDITIONAL CLARIFICATION OR LOCATION OF SOME ITEMS. LANDSCAPE CONTRACTOR SHALL NOT LOCATE ANY ITEMS WHERE IT IS OBVIOUS THAT THEY ARE IN DIRECT CONFLICT WITH PERMANENT IMPROVEMENTS, OR PEDESTRIAN AND VEHICULAR SAFETY CONSIDERATIONS, OR CAUSE DAMAGE TO UTILITIES. LANDSCAPE CONTRACTOR SHALL NOT INSTALL ANY PLANT MATERIALS IN LOCATIONS WHERE THE ULTIMATE GROWTH OF THE PLANT MATERIALS WILL DAMAGE OR AFFECT STRUCTURES OR IMPEDE PEDESTRIAN OR VEHICULAR CIRCULATION. DO NOT LOCATE TREES OR TALLER SHRUBS IN LOCATIONS WHERE THEY WILL BLOCK IRRIGATION HEADS AND PREVENT ADEQUATE COVERAGE. WHERE CALLED FOR, OBTAIN APPROVAL OF THE LANDSCAPE ARCHITECT FOR PLACEMENT OF TREES, SHRUBS, AND OTHER ITEMS OF WORK.

3.4.4
LOCATE TREES AND TALLER SHRUBS 10' MINIMUM AWAY FROM ROTOR IRRIGATION HEADS, 5' MINIMUM FROM SPRAY HEADS.

3.4.5
INSURE THAT ALL TREES AND LARGER SHRUBS ARE NOT IN CONFLICT WITH ANY UNDERGROUND UTILITIES. DAMAGE TO UNDERGROUND UTILITIES SHALL BE THE RESPONSIBILITY OF THE LANDSCAPE CONTRACTOR AND SHALL BE REPLACED AT NO COST TO THE OWNER.

3.5 PLANT PITS AND PLANTING TECHNIQUE

3.5.1
PLANT PITS SHALL BE DUG WITH LEVEL BOTTOMS WITH WIDTHS AND DEPTHS AS SHOWN IN DETAIL DRAWINGS. PITS FOR TREES SHALL BE DUG SQUARE. FILL PITS WITH WATER AND ALLOW TO PERCOLATE OUT OVER A 12 HOUR PERIOD. REFILL HOLE AND IF WATER IS NOT ABSORBED WITHIN 12 HOURS OF THE SECOND FILLING, CONTACT LANDSCAPE ARCHITECT FOR DIRECTION.

3.5.2
PLANT HOLES DUG BY AUGER METHOD WILL BE ACCEPTABLE, BUT SHALL HAVE SIDE WALLS ROUGHENED OR SQUARED WITH A SHOVEL. SLICK PIT WALLS CAUSED BY AUGERING IN TOO WET SOIL WILL NOT BE ACCEPTED FOR PLANTING.

3.5.3
CONTAINER STOCK SHALL BE REMOVED CAREFULLY FROM CONTAINER AFTER LIGHTLY COMPRESSING THE SIDES OF THE CONTAINERS TO LOOSEN THE ROOT BALL. SLIDE PLANTS AND HANDLE BY EARTH BALL ONLY.

3.5.4
HANDLING: NO CONTAINERIZED PLANT MATERIAL SHALL BE PLANTED IF THE BALL IS BROKEN OR CRACKED EITHER BEFORE OR DURING THE PROCESS OF PLANTING.

3.5.5
SETTING: PLANTS SHALL BE SET WITH TOP OF ROOT BALL 1" ABOVE FINISH GRADE. EACH PLANT SHALL BE PLACED IN CENTER OF PLANT PIT.

3.5.6 PIT BACKFILLING

3.5.6.1
BACKFILL MATERIAL FOR PLANT PITS SHALL BE A MIXTURE AS NOTED BELOW OR AS INDICATED ON DRAWINGS. THE MATERIALS SHALL BE THOROUGHLY BATCH-MIXED PRIOR TO PLACEMENT SO THAT THEY ARE EVENLY DISTRIBUTED AND WITHOUT CLODS OR LUMPS. BACKFILL SHALL BE SO PLACED IN THE PITS THAT THE PLANT WILL BE AT ITS NATURAL GROWING HEIGHT AFTER SETTLEMENT.

90% BY VOLUME - EXCAVATED SOIL, FREE FROM ROCKS, ETC. (PER SECTION 3.2.6) 10% BY VOLUME - COMPOSTED ORGANIC SOIL AMENDMENT (PER SECTION 2.2.3)
10 LBS - AGRICULTURAL GYPSUM PER CU. YD. OF MIX (PER SECTION 2.2)
8 LBS - TRI-C 6-2-4 W/5% SULFUR PER CU. YD. OF MIX

3.5.6.2 PALM BACKFILL, AMOUNTS PER CU. YD.:

1 PART - COMPOSTED ORGANIC SOIL AMENDMENT (PER SECTION 2.2.3)
5 PARTS - WASHED PLASTER
1 LB. - SLOW RELEASE PALM FERTILIZER

3.5.6.3 CAMELLIA, AZALEA, GARDENIA, FERN, AND CLIVIA BACKFILL, AMOUNTS PER CU. YD.:

2 PARTS - COMPOSTED ORGANIC SOIL AMENDMENT (PER SECTION 2.2.3)
1 PART - WASHED PLASTER SAND
3 LBS. - 16-8-8 FERTILIZER
1 LB. - SEQUESTERINE FE330 IRON CHELATE
5 LBS. - TRI-C PREMIUM HUMATE

3.5.6.4 BUILD MOUND OF COMPACTED BACKFILL WIDE ENOUGH IN BOTTOM OF HOLE TO SUPPORT ROOT BALL.

3.5.6.5 BACKFILL PIT WITH BACKFILL MIX HALFWAY TO FINISH GRADE AND WATER THOROUGHLY.

3.5.6.6
PLACE 7 GRAM MYCO PAKS FOR GALLON MATERIAL IN PLANT PITS, ADHERING TO THE FOLLOWING SCHEDULE:
1 GAL. 5 GAL. 15GAL. 24" BOX 36" BOX
1 PAK 2-3 PAKS 6-8 PAKS 10-12 PAKS 16-18 PAKS
48" BOX 60" BOX 72" BOX 84" BOX 96" BOX
20-22 PAKS 26-28 PAKS 32-34 PAKS 40-42 PAKS 46-48 PAKS

3.5.6.7
BACKFILL TO FINISH GRADE. BACKFILL MIX SHALL BE TAMPED LIGHTLY, AND A SHALLOW BASIN FORMED AT PERIMETER OF ROOT BALL TO HOLD ENOUGH WATER TO SATURATE THE ROOT BALL AND BACKFILL MIX.

3.5.6.8
WATER IMMEDIATELY TO SATURATE ENTIRE ROOT BALL AND BACKFILL.

3.5.6.9
REMOVE WATERING BASIN PRIOR TO HYDROSEEDING (IN TURF AREAS ONLY).

3.5.7 BOUGAINVILLEA PLANTING NOTES

3.5.7.1
DO NOT REMOVE BOUGAINVILLEAS FROM CONTAINERS. PLACE IN HOLE AND CUT CONTAINER ON FOUR SIDES. BE CAREFUL NOT TO CUT ROOTS, OR DISTURB INTEGRITY OF ROOTBALL. CUT AWAY SIDES OF CONTAINER AND BACKFILL PER SECTION 3.5.3 ABOVE.

3.5.8 ROOT BARRIERS

3.5.8.1
THE CONTRACTOR SHALL INSTALL THE TREE ROOT BARRIERS WITH THE NUMBER OF PANELS AND IN THE MANNER SHOWN ON THE DRAWINGS OR DETAILS. THE VERTICAL ROOT DEFLECTING RIBS SHALL BE FACING INWARDS TO THE ROOT BALL AND THE TOP OF THE DOUBLE EDGE SHALL BE 1/2" (12.7MM) ABOVE GRADE. EACH OF THE REQUIRED NUMBER OF PANELS SHALL BE CONNECTED IN A LINEAR FASHION AND PLACED ALONG THE ADJACENT HARDCAPE.

EXCAVATION AND SOIL PREPARATION SHALL CONFORM TO THE DRAWINGS

3.6 TREE STAKING

3.6.1
STAKE ALL TREES AS SHOWN IN DETAILS.

3.6.2
TREE AND STAKES SHALL BE VERTICAL IN ALL CASES.

3.6.3
ONE-GALLON TREES SHALL BE PLANTED WITH NURSERY STAKES REMOVED.

3.7 TREE GUYING

3.7.1
GUY 36" BOX AND LARGER PLANT MATERIAL WITH AT LEAST THREE GUYS IN TRIANGULAR PATTERN (PER DETAILS). WIRE SHALL BE ENCASED IN NEW RUBBER HOSE WHERE IT COMES IN CONTACT WITH TREE. LOCATE LOOPS ON BRANCHES PER DETAILS AND SO THAT CABLES DO NOT CHAFE ON EACH OTHER OR BRANCHES.

3.7.2
USE ONLY MANUFACTURER-APPROVED DRIVING RODS FOR INSTALLATION OF ANCHORS. SET ANCHOR, USING METHOD RECOMMENDED BY MANUFACTURER APPROPRIATE FOR SIZE ANCHOR BEING DRIVEN.

3.7.3
GUYING REQUIREMENT MAY BE OMITTED BY LANDSCAPE ARCHITECT WHEN CONDITIONS PERMIT. IF OMITTED, CREDIT SHALL BE GIVEN BACK TO OWNER.

3.8 SODDED LAWN

3.8.1
SOD SHALL BE HARVESTED, DELIVERED AND INSTALLED WITHIN A PERIOD OF 24 HOURS, UNLESS A SUITABLE PRESERVATION METHOD IS APPROVED PRIOR TO DELIVERY. SOD NOT INSTALLED WITHIN THIS PERIOD SHALL BE INSPECTED AND ACCEPTED BY THE LANDSCAPE ARCHITECT. SOD SHALL NOT BE HARVESTED OR TRANSPORTED WHEN MOISTURE CONTENT (EXCESSIVELY DRY OR WET) MAY ADVERSELY AFFECT ITS UNIFORMITY AT A HEIGHT OF 2" TO 2-1/2" AND ALL CLIPPINGS REMOVED.

3.8.2
PREPARE SOD BED PER SOIL PREPARATION SPECIFICATIONS PRIOR TO INSTALLATION OF SOD. BROADCAST FERTILIZER AS SUPPLIED BY GROWER AT 2 LBS./1,000 SQ. FT. PRIOR TO LAYING SOD.

3.8.3
ROLL AREA TO BE SODDED WITH WATER-FILLED ROLLER TO ERADICATE ANY POSSIBLE AIR POCKETS. FILL ANY AREAS OF SETTLEMENT. WATER THOROUGHLY TO A PENETRATION DEPTH OF AT LEAST 6". REGRADE SOIL IF SETTLING OCCURS. ORDER SOD TO BE CUT AND DELIVERED ONLY AFTER SITE IS PREPARED FOR INSTALLATION. UNROLL SOD IN SAME DIRECTION EACH TIME. SOD SHALL BE LAID IN A STAGGERED PATTERN, WITH NO GAPS OR VOIDS. CUT ROLLS AS NECESSARY TO FIT, WITH NO LENGTHS SHORTER THAN 18". START LAYING SOD ALONG LONGEST STRAIGHT EDGE AND AT BOTTOM OF SLOPES. PEG BOTH ENDS OF EVERY ROLL OF SOD WHEN LAYING SOD ALONG ON SLOPES GREATER THAN 3:1. PIN DOWN SOD WITH WOODEN PEGS, WATER SOD WITHIN 30 MINUTES OF LAYING. IF SOD ENDS AGAINST AND OPEN BED OF SOIL, MOUND THE SOIL AGAINST THE NEW SOD TO KEEP THE EDGES FROM DRYING, OR REGRADE THE SOIL TO PROVIDE THIS PROTECTION AUTOMATICALLY. WATER THOROUGHLY AT THE END OF DAY ALL SOD PLACED THAT DAY TO PENETRATE SOIL AT LEAST 6".

3.8.4
ROLL ALL SODDED AREAS WITH A ROLLER WEIGHING APPROXIMATELY 16 POUNDS PER LINEAL INCH TO COMPACT THE SOIL AROUND THE ROOTS AND PROVIDE A SMOOTH, EVEN MOWING SURFACE.

3.9 FLATTED GROUND COVER

3.9.1
ROOTED CUTTINGS SHALL BE PLANTED SUFFICIENTLY DEEP TO COVER ALL ROOTS AND SPACED AS SPECIFIED IN PLANT MATERIAL LEGEND ON LANDSCAPE PLAN.

3.9.2
ROOTED CUTTINGS SHALL NOT BE ALLOWED TO DRY OUT BEFORE OR WHILE BEING PLANTED. WILTED PLANTS SHALL NOT BE ACCEPTED.

3.9.3
AT TIME OF PLANTING ALL GROUND COVER PLANTS, THE EARTH AROUND EACH PLANT SHALL BE FIRMED SUFFICIENTLY TO FORCE OUT ALL AIR POCKETS.

3.9.4
EACH GROUND COVER PLANT SHALL BE PLANTED WITH A MINIMUM OF ONE (1) 5 GRAM 20-15-5 PLANT TABLET ADJACENT TO ROOT ZONE.

3.10 APPLICATION OF PRE-EMERGENT HERBICIDE(S)

3.10.1
APPLY PRE-EMERGENT HERBICIDE(S) TO SHRUB AND PLANTED GROUND COVER AREAS ONLY. DO NOT APPLY TO HYDROSEEDED AREAS. STRICTLY ADHERE TO MANUFACTURER'S SPECIFICATIONS FOR APPLICATION RATES AND METHODS.

3.10.2
APPLY PRE-EMERGENT(S) ONLY AFTER ALL PLANTING OPERATIONS HAVE BEEN COMPLETED SO AS TO MINIMIZE DISTURBANCE OF THE CHEMICAL "BARRIER". REAPPLY WHERE NECESSARY TO ANY AREAS DISTURBED BY PLANTING OR REPAIR OPERATIONS AFTER IR REEL-INITIAL APPLICATION.

3.10.3
PAY CAREFUL ATTENTION TO ACTIVATION REQUIREMENTS, "WATERING-IN", ETC., PER MANUFACTURER'S SPECIFICATIONS AND LABEL INSTRUCTIONS. AVOID EXCESSIVE IRRIGATION RUN-OFF THAT WOULD MOVE OR WASH AWAY THE PRE-EMERGENT "BARRIER" --- USE REPEAT WATERING CYCLES AND SPLIT WATERING TIMES.

3.12 MULCHING OF GROUND COVER AREAS

3.12.1
AFTER, PLANTING OPERATIONS ARE COMPLETE AND GROUND COVER AREAS HAVE BEEN RAKED AND DRESSED, APPLY 3" THICK LAYER OF 400 PLUS ORGANIC MULCH BY GREENEARTH: (760) 639-6296, TO ALL OTHER GROUND COVER AREAS.

3.12.2
COBBLES AND PEBBLES, DECOMPOSED GRANITE, OR CRUSHED STONE LAYER SHOULD TAPER TO ZERO AT PLANT STEM OR TREE TRUNK. DO NOT PLACE MULCH MATERIALS UP AGAINST PLANT CROWN OR TRUNK.

3.13 PROTECTION

3.13.1
THE LANDSCAPE CONTRACTOR SHALL CAREFULLY AND CONTINUOUSLY PROTECT ALL AREAS INCLUDED IN THE CONTRACT, INCLUDING LAWN AREAS, PLANT MATERIAL, SUPPORTS, ETC. UNTIL FINAL ACCEPTANCE OF THE WORK BY THE OWNER OR HIS REPRESENTATIVE.

3.14 CLEAN-UP

3.14.1
AFTER ALL PLANTING OPERATIONS ARE COMPLETED, LANDSCAPE CONTRACTOR SHALL REMOVE ALL TRASH, EXCESS SOIL, EMPTY PLANT CONTAINERS, OR OTHER ACCUMULATED DEBRIS FROM THE SITE AT NO EXTRA COST TO OWNER. LANDSCAPE CONTRACTOR SHALL REPAIR ALL SCARS, RUTS, OR MARS IN AREA CAUSED BY WORK OPERATIONS. AREAS SHALL BE LEFT IN A NEAT AND ORDERLY CONDITION.

3.15 OBSERVATIONS (PLANTING PHASE).

3.15.1
LANDSCAPE CONTRACTOR SHALL GIVE FORTY-EIGHT (48) HOURS NOTICE AND SET APPOINTMENT FOR ALL OBSERVATION BY THE LANDSCAPE ARCHITECT. IF WORK IS NOT COMPLETED WHEN LANDSCAPE ARCHITECT IS CALLED FOR REVIEW AND LANDSCAPE ARCHITECT SHALL BE REQUIRED TO RESCHEDULE THIS REVIEW, THE LANDSCAPE CONTRACTOR SHALL PAY THE LANDSCAPE ARCHITECT FOR HIS TIME, INCLUDING TRAVEL TIME, AT HIS CONTRACTED HOURLY RATE.

3.15.2
REVIEW BY LANDSCAPE ARCHITECT SHALL BE SCHEDULED FOR THE FOLLOWING OPERATIONS:

3.15.2.1 REVIEW OF FINISH GRADING.

3.15.2.2
REVIEW OF ALL PLANT MATERIAL AFTER DELIVERY TO THE SITE.

3.15.2.3
TREE AND SHRUBS PLACEMENT PRIOR TO DIGGING HOLES.

3.15.2.4
REVIEW OF GROUND COVER LINES AND HEADERBOARD PRIOR TO PLANTING.

3.15.2.5
START OF ESTABLISHMENT PERIOD/ACCEPTANCE OF INSTALLATION.

3.15.2.6
FINAL ACCEPTANCE AT END OF ESTABLISHMENT PERIOD.

3.15.3
REVIEWS SHALL BE CALLED FOR AT THE END OF ALL PLANTING OPERATIONS FOR THE PURPOSE OF DETERMINING COMPLIANCE WITH DRAWINGS AND SPECIFICATIONS, INTENT, WORKMANSHIP, AND CLEAN-UP. LANDSCAPE CONTRACTOR SHALL SECURE WRITTEN VERIFICATION OF REVIEW DATA, ANY CORRECTIONS REQUIRED TO WORK, AND LIMITS OF REVIEWED AREA BEFORE BEGINNING THE DESCRIBED ESTABLISHMENT WORK.

3.15.4
IN THE EVENT THE LANDSCAPE CONTRACTOR REQUESTS INSPECTION OF WORK, AND SAID WORK IS SUBSTANTIALLY INCOMPLETE, THE LANDSCAPE CONTRACTOR SHALL BE RESPONSIBLE FOR LANDSCAPE ARCHITECT'S HOURLY CHARGES AND PER DIEM COSTS.

3.16 N/A

3.16.1 N/A

3.17 GUARANTEE

3.17.1
ALL SHRUBS, GROUND COVERS, LAWN AREAS, AND 15 GALLON SIZE TREES OR LESS SHALL BE GUARANTEED AS TO GROWTH AND HEALTH FOR A PERIOD OF NINETY (90) DAYS AFTER FINAL ACCEPTANCE BY THE OWNER OR HIS REPRESENTATIVE. BOX SIZED TREES SHALL BE GUARANTEED FOR A PERIOD OF ONE (1) YEAR AFTER DATE OF SUBSTANTIAL COMPLETION.

3.17.2
PLANTS WHICH DIE OR LOSE MORE THAN THIRTY PERCENT (30%) OF THEIR ORIGINAL LEAVES SHALL BE REPLACED UNDER THIS SECTION.

3.17.3
THE LANDSCAPE CONTRACTOR, WITHIN FOURTEEN (14) DAYS OF WRITTEN NOTIFICATION BY THE OWNER, SHALL REMOVE AND REPLACE ALL GUARANTEED PLANT MATERIALS WHICH FOR ANY REASON FAIL TO MEET THE REQUIREMENTS OF THE GUARANTEE. ALL PLANTS MATERIAL REPLACED SHALL BE GUARANTEED FOR THE ORIGINAL PERIOD, STARTING FROM THE DATE OF REPLACEMENT.

PART 4 ESTABLISHMENT / MAINTENANCE PERIOD

4.1
LANDSCAPE CONTRACTOR SHALL CONTINUOUSLY PROTECT AND MAINTAIN ALL AREAS INCLUDED IN THE CONTRACT DURING THE PROGRESS OF THE WORK, THROUGH THE ESTABLISHMENT PERIOD, AND UNTIL FINAL ACCEPTANCE OF THE WORK.

4.2
THE ENTIRE PROJECT SHALL BE CONTINUOUSLY AND SATISFACTORILY MAINTAINED FOR A PERIOD OF NINETY (90) CALENDAR DAYS. THE LANDSCAPE CONTRACTOR SHALL CALL FOR THE START OF ESTABLISHMENT PERIOD INSPECTION ONLY AFTER THE FIRST MOWING OF HYDROSEEDED GRASS AND AFTER AT LEAST 50% GERMINATION OF SLOPE HYDROSEEDING. ESTABLISHMENT PERIOD SHALL COMMENCE UPON THE DATE OF COMPLETION OF THE WORK, AS AUTHORIZED IN A WRITTEN NOTICE FROM THE LANDSCAPE ARCHITECT AFTER THE START OF ESTABLISHMENT PERIOD INSPECTION HAS BEEN COMPLETED AND ALL PUNCH LIST ITEMS HAVE BEEN CORRECTED BY THE LANDSCAPE CONTRACTOR.

4.3
CONTINUOUS MAINTENANCE AND ESTABLISHMENT WORK INCLUDES ALL MOWING, WATERING, WEEDING, RESEEDING, MULCHING, CULTIVATING, SPRAYING AND TRIMMING NECESSARY TO BRING THE PLANTED AREAS TO A HEALTHY GROWING CONDITION, AND ANY ADDITIONAL WORK NEEDED TO KEEP THE AREAS NEAT, EDGED, AND ATTRACTIVE.

4.4 WATERING:

4.4.1
WATER GRASS UNTIL FINAL ACCEPTANCE OF WORK. THE AREAS SHALL BE KEPT MOIST, BUT NOT GUSTENING WET, UNTIL TIME FOR THE FIRST CUTTING OF GRASS. AFTER FIRST CUTTING, WATER LAWN TO MAINTAIN A THRIVING CONDITION. DO NOT OVERWATER.

4.4.2
PAY SPECIAL ATTENTION TO WATERING SLOPED AREAS PLANTED IN LAWN ON THE WINDWARD AND / OR SUNNY SIDE SO THAT LAWN WILL BE ADEQUATELY WATERED AT ALL TIMES.

4.4.3
MONITOR WATERING USE ON A DAILY BASIS, AND MAKE ADJUSTMENTS TO CONTROLLER WATERING SCHEDULE AS NECESSARY TO APPLY ONLY THE PROPER AMOUNT OF WATER AT ALL TIMES. ADJUST WATERING SCHEDULE TO COMPENSATE FOR CHANGES IN ETO, RAINFALL, AND TEMPERATURE.

4.4.4
LANDSCAPE CONTRACTOR SHALL ONLY APPLY SUFFICIENT WATER TO PROMOTE HEALTHY GROWTH OF THE PLANT MATERIAL. AT NO TIME SHALL THE LANDSCAPE CONTRACTOR APPLY WATER AT A RATE OR FREQUENCY THAT CAUSES RUNOFF OR SOIL SATURATION.

4.4.5
LANDSCAPE CONTRACTOR SHALL MAINTAIN A DAILY LOG OF WATERING TIMES ON THE JOBSITE, AND MAKE IT AVAILABLE FOR INSPECTION BY THE LANDSCAPE ARCHITECT.

4.5
DURING THE PLANT ESTABLISHMENT PERIOD, ALL PLANTS AND PLANTED AREAS SHALL BE KEPT WEED FREE AT ALL TIMES. WEEDS, NUT GRASS, DALLAS GRASS, JOHNSON GRASS, BERMUDA GRASS, AND ANY OTHER NOXIOUS GRASS SPECIES SHALL BE REMOVED AND DISPOSED OF AS THEY APPEAR.

4.6
EDGING: THE LAWNS SHOULD BE EDGED WHENEVER NECESSARY. THE LAWN EDGES SHALL BE CONTINUOUSLY MAINTAINED IN A NEAT CONDITION UNTIL FINAL ACCEPTANCE OF THE WORK.

4.7
FIRST MOWING OF HYDROSEEDED GRASS SHALL OCCUR BEFORE GRASS EXCEEDS 4" IN HEIGHT. GRASS SHALL BE MOWED WITH SHARP AND ADJUSTED MOWERS, SIZED APPROPRIATELY FOR THE SIZE(S) OF THE AREA(S) BEING MOWED. MOWING HEIGHTS FOR VARIOUS TYPES OF TURFGRASS ARE GIVEN BELOW:

4.7.1
2ND & SUBSEQUENT MOWER TURFGRASS TYPE 1ST MOWING MOWINGS TYPE BERMUDAGRASS 1-1/2" 1" FLAIL OR REEL

4.7.2
COOL SEASON GRASSES 2-1/2" 1-1/2" ROTARY (FESCUE, RYEGRASS, BLUEGRASS)

4.8
WHERE TREES OCCUR IN GRASS AREAS, THE GRASS SHALL BE REMOVED AND NEATLY EDGED 2" AWAY FROM THE TRUNKS (48" DIAMETER).

4.9
WORKPERSONS SHALL NOT BE ALLOWED TO WALK ON GRASS AREAS UNNECESSARILY BEFORE, DURING, OR AFTER SEEDING OPERATION. GRASS AREAS THAT HAVE BEEN DAMAGED OR COMPACTED SHALL BE RE-CULTIVATED AND RESEEDED AT THE LANDSCAPE CONTRACTOR'S EXPENSE.

4.10
ANY DAY THE LANDSCAPE CONTRACTOR FAILS TO ADEQUATELY WATER, REPLACE UNSUITABLE PLANTS, WEED, AND OTHER WORK DETERMINED TO BE NECESSARY BY THE LANDSCAPE ARCHITECT, WILL NOT BE CREDITED AS PART OF THE ESTABLISHMENT PERIOD.

4.11
DURING THE ESTABLISHMENT PERIOD, ANY PLANT INDICATING WEAKNESS OR PROBABILITY OF DYING, SHALL BE REPLACED BY THE LANDSCAPE CONTRACTOR AT HIS OWN EXPENSE.

4.12
TREE STAKES WHICH FOR ANY REASON ARE DAMAGED OR RENDERED INADEQUATE FOR SUPPORT SHALL BE REPAIRED AND RESTORED TO THEIR ORIGINAL CONDITION.

4.13
CONSTANT DILIGENCE SHALL BE MAINTAINED TO DETECT THE PRESENCE OF DISEASE, INSECTS, AND/OR RODENT INFESTATIONS AND PROPER PREVENTATIVE OR CONTROL MEASURES TAKEN. THIS WILL BE DONE AT NO ADDITIONAL COST TO THE OWNER.

4.14
SHRUBS AND TREES SHALL BE MAINTAINED IN THEIR NATURAL SHAPES. TALL OR SCRAGGLY BRANCHES SHALL BE THINNED OUT WHERE NECESSARY. IN NO CASE SHALL TREES OR SHRUBS BE TRIMMED BY HEADING, SHEARING OR 'LOLLY POPPED'. ANY PLANTS SEVERELY PRUNED IN THIS MANNER SHALL BE REMOVED AND REPLACED AT LANDSCAPE CONTRACTOR'S EXPENSE.

4.15
ON THE 45TH DAY OF THE ESTABLISHMENT PERIOD, ALL LAWNS AREAS SHALL RECEIVE TOP DRESSING OF TEN (10) POUNDS OF 16-8-8 COMMERCIAL FERTILIZER PER 1,000 SQUARE FEET.

4.16
ON THE 80TH DAY OF THE ESTABLISHMENT PERIOD, LAWNS AND GROUNDCOVER AREAS SHALL RECEIVE TOP DRESSING OF TEN (10) POUNDS OF 16-8-8 COMMERCIAL FERTILIZER PER 1,000 SQUARE FEET.

4.17
AT COMPLETION OF ESTABLISHMENT PERIOD, AREAS INCLUDED IN THE CONTRACT SHALL BE SUBSTANTIALLY CLEAN AND FREE OF DEBRIS AND WEEDS. PLANT MATERIALS SHALL BE LIVE, HEALTHY, AND FREE OF INFESTATIONS.

4.18
ANY EROSION OR SLIPPAGE OF SOIL CAUSED BY WATERING SHALL BE REPAIRED BY THE LANDSCAPE CONTRACTOR AT HIS EXPENSE.

4.19
WALKS, CURBS, AND GUTTERS SHALL BE KEPT CLEAR OF DEBRIS, MUD, DUST, AND STANDING WATER BY SWEEPING, MOPPING OR HOSING DOWN AS REQUIRED TO MAINTAIN CLEANLINESS THROUGHOUT.

4.20
LANDSCAPE CONTRACTOR IS RESPONSIBLE FOR PROTECTING THE WORK COVERED BY THIS SECTION FROM VANDALISM AND ACCIDENTAL DAMAGE. ANY DAMAGE SHALL BE PROMPTLY REPAIRED BY THE LANDSCAPE CONTRACTOR AT NO ADDITIONAL COST TO THE OWNER. LANDSCAPE CONTRACTOR IS RESPONSIBLE FOR ALL REPAIRS OR REPLACEMENTS CAUSED BY ACTS OF VANDALISM, INCLUDING REMOVAL OF GRAFFITI, AND/OR REFINISHING, AS REQUIRED.

4.21
LANDSCAPE CONTRACTOR IS RESPONSIBLE FOR PROTECTING THE WORK COVERED BY THIS SECTION FROM DAMAGE CAUSED BY FROST AND/OR TORRENTIAL RAINS. ANY DAMAGE SHALL BE PROMPTLY REPAIRED BY THE LANDSCAPE CONTRACTOR AT NO ADDITIONAL COST TO THE OWNER. PLANT MATERIALS DAMAGED BY FROST AND/OR TORRENTIAL RAINS SHALL BE REPLACED BY THE LANDSCAPE CONTRACTOR AT NO ADDITIONAL COST TO THE OWNER.

PART 5 PAYMENT

5.1
PAYMENT FOR THE WORK OF THIS SECTION SHALL BE INCLUDED IN THE PRICE BID FOR LANDSCAPE FINISH GRADING, PLANTING, AND ESTABLISHMENT PERIOD AND NO ADDITIONAL COSTS WILL BE CONSIDERED.

5.2
AT THE END OF THE SPECIFIED ESTABLISHMENT PERIOD, THE LANDSCAPE CONTRACTOR SHALL PRESENT WRITTEN NOTICE TO THE LANDSCAPE ARCHITECT AND OWNER THAT HE HAS COMPLETED THE REQUIRED MAINTENANCE AND SUBMIT THE RECORD DRAWINGS. FURTHER MAINTENANCE WILL BE THE RESPONSIBILITY OF THE OWNER.

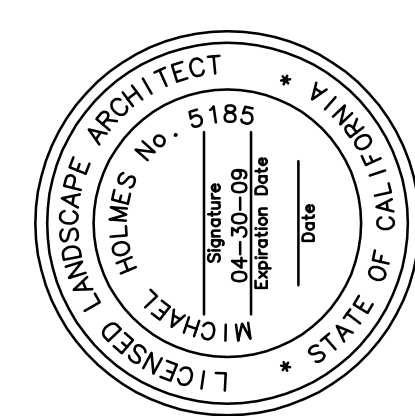

Pinnacle Civil Engineering, Inc.
2161 Saturn Court, Bakersfield, CA 93308
Phone: (661) 869-0184 Fax: (661) 377-0076

MICHAEL HOLMES	LA 5185 EXP. 4/30/09	DATE
REVISIONS	DELETED NORTH PORTION OF SITE	7-14-09
	SPECIFIED TREES AND IRRIGATION COMPONENTS	

LANDSCAPE SPECIFICATIONS
BCSD - WAYSIDE ELEMENTARY
LANDSCAPE SPECIFICATIONS
BAKERSFIELD, CALIFORNIA

CALL: 1-800-227-2600

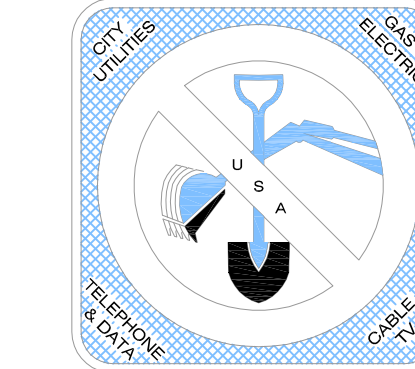

JOB No.:	07-320
DWG NO.:	07-320GRBM
DATE:	04/07/08
DRAWN BY:	MH
CHECKED BY:	MH
SHEET	3
	OF 7 SHEETS

LANDSCAPE IRRIGATION SPECIFICATIONS

PART 1 – GENERAL

1.1. DEFINITIONS:

1.1.1. CITY: BAKERSFIELD

1.1.2. OWNER: BCSD-WAYSIDE ELEMENTARY

1.1.3. LANDSCAPE ARCHITECT: PINNACLE CIVIL ENGINEERING INC.

1.2. SCOPE OF CONTRACT:

1.2.1. N/A

1.2.2. N/A

1.3. LANDSCAPE CONSTRUCTION DOCUMENTS

1.3.1. N/A

1.3.2. THESE PLANS ARE PREPARED FOR THE CONVENIENCE OF THE CONTRACTOR, THE CONTRACTOR SHALL VERIFY ALL SITE CONDITIONS, WHICH MAY AFFECT THE INTENDED DESIGN OF THE LANDSCAPE WORK. ANY DISCREPANCIES SHALL BE REPORTED TO THE OWNER'S REPRESENTATIVE IMMEDIATELY.

1.3.3. THE IRRIGATION DESIGN AS INDICATED ON THE PLANS IS DIAGRAMMATIC. SCALED DIMENSIONS ARE APPROXIMATE. VERIFY ALL SITE DIMENSIONS PRIOR TO PROCEEDING WITH THE WORK.

1.4. RELATED DOCUMENTS:

1.4.1. LOCAL, MUNICIPAL AND STATE CODES, LAWS, RULES AND REGULATIONS GOVERNING OR RELATING TO ANY PORTION OF THIS WORK ARE HEREBY MADE A PART OF THESE PLANS AND SPECIFICATIONS.

1.4.2. N/A

1.4.3. N/A

1.4.4. N/A

1.5. DESCRIPTION OF WORK:

1.5.1. N/A

1.5.2. THE INTENT OF THE DRAWINGS AND SPECIFICATIONS IS TO INDICATE AND SPECIFY A COMPLETE IRRIGATION SYSTEM, INSTALLED READY FOR USE WITHOUT FURTHER COST IN LABOR OR MATERIALS TO THE OWNER AND COMPLYING WITH ALL APPLICABLE CODES, SPECIFICATIONS AND DETAILS.

1.6. QUALITY ASSURANCE:

1.6.1. N/A

1.7. PRODUCT DATA SUBMITTALS:

1.7.1. N/A

1.8. RECORD DRAWINGS:

1.8.1. N/A

1.8.2. N/A

1.8.3. N/A

1.8.4. N/A

1.8.5. N/A

1.8.6. N/A

1.8.7. N/A

1.9. CONTROLLER CHARTS:

1.9.1. THE CONTRACTOR SHALL PREPARE A COLOR-CODED CHARTS SHOWING THE VALVES, MAINLINE, AND SPRINKLER HEADS SERVICED BY THAT PARTICULAR CONTROLLER.

1.9.2. WITHIN EACH CONTROLLER, EACH VALVE/SYSTEM SHALL BE IDENTIFIED BY A UNIQUE COLOR.

1.9.3. ALL VALVES SHALL BE NUMBERED TO MATCH THE OPERATION SCHEDULE AND THE DRAWINGS. ONLY THOSE AREAS CONTROLLED BY THAT CONTROLLER SHALL BE SHOWN.

1.9.4. CONTROLLER CHARTS SHALL BE A PLOT PLAN, ENTIRE OR PARTIAL, SHOWING BUILDINGS, WALKS, ROADS AND WALLS. A PHOTOSTATIC PRINT OF THIS PLAN, REDUCED AS NECESSARY AND LEGIBLE IN ALL DETAILS, SHALL BE MADE TO A SIZE THAT WILL FIT INTO THE CONTROLLER COVER.

1.9.5. THIS PRINT SHALL BE APPROVED BY THE LANDSCAPE ARCHITECT OR THE OWNER'S AUTHORIZED REPRESENTATIVE AND SHALL BE HERMETICALLY SEALED BETWEEN TWO PIECES OF TEN MIL THICK PLASTIC.

1.9.6. FOR EACH CONTROLLER, THE CONTRACTOR SHALL PROVIDE TWO SETS OF 11" X 17" CONTROLLER CHARTS AS FOLLOWS:

ONE COLOR CODED LAMINATED SET TO: OWNER

ONE COLOR CODED LAMINATED SET TO: SECURED ON THE INSIDE SURFACE OF THE COVER OF EACH AUTOMATIC CONTROLLER.

1.10. EQUIPMENT, KEYS, MANUALS & CERTIFICATIONS:

1.10.1. UPON COMPLETION OF THE CONTRACTOR'S MAINTENANCE PERIOD, THE CONTRACTOR SHALL PROVIDE THE FOLLOWING EQUIPMENT TO THE OWNER:
(2) CONTROLLER/C.C.U. ENCLOSURE KEYS FOR EACH ENCLOSURE.
(2) KEYS TO ACCESS SPECIAL ELECTRICAL SWITCH INSIDE EACH CONTROLLER ENCLOSURE.

(1) ACME THREAD QUICK COUPLING KEYS AND MATCHING SWIVELS FOR WATER IRRIGATION SYSTEMS.
(2) SETS OF TOOLS REQUIRED FOR SERVICING AND/OR ADJUSTING EACH SPRINKLER AND VALVE TYPE.

(1) COPY OF THE BACKFLOW PREVENTION DEVICE CERTIFICATION.

1.10.2. THE CONTRACTOR SHALL SUBMIT THE FOLLOWING TO THE OWNER'S REPRESENTATIVE:

(1) CONTROLLER/C.C.U. ENCLOSURE KEYS FOR EACH ENCLOSURE.

(1) CONTROLLER/C.C.U. KEYS FOR EACH CONTROLLER.

(1) KEYS TO ACCESS SPECIAL ELECTRICAL SWITCH INSIDE EACH CONTROLLER ENCLOSURE.

(1) STANDARD QUICK COUPLING LOCKING COVER KEYS

(1) ACME THREAD QUICK COUPLING KEYS AND MATCHING SWIVELS FOR IRRIGATION SYSTEMS.

(2) SETS OF TOOLS REQUIRED FOR SERVICING AND/OR ADJUSTING EACH SPRINKLER AND VALVE TYPE.

(1) COPY OF THE BACKFLOW PREVENTION DEVICE CERTIFICATION.

(2) SETS OF SERVICE MANUALS FOR ALL IRRIGATION EQUIPMENT INSTALLED.

1.11. GUARANTEES:

1.11.1. CONTRACTOR SHALL FURNISH A WRITTEN GUARANTEE IN ACCORDANCE WITH THE GENERAL CONDITIONS, FOR A PERIOD OF ONE (1) YEAR FROM THE DATE OF FINAL ACCEPTANCE AND CONCLUSION OF THE MAINTENANCE PERIOD. GUARANTEE SHALL COVER THE COMPLETE IRRIGATION SYSTEM, INCLUDING SETTLING OF THE BACKFILL IN TRENCHES AND REPAIRS AND/OR REPLACEMENT OF ANY MATERIAL DAMAGED THEREBY OR THERE FROM.

1.11.2. MANUFACTURER'S WARRANTIES SHALL NOT RELIEVE THE CONTRACTOR OF HIS LIABILITY UNDER THE GUARANTEE. SUCH WARRANTY SHALL ONLY SUPPLEMENT THE GUARANTEE.

1.12. WATER SERVICE:

1.12.1. POINT OF CONNECTIONS SHOWN ON PLANS ARE APPROXIMATE. CONTRACTOR SHALL COORDINATE WITH OWNER'S AUTHORIZED REPRESENTATIVE AND GOVERNING WATER DISTRICT TO HAVE WATER AVAILABLE WHEN REQUIRED.

1.12.2. N/A

1.12.3. N/A

1.13. ELECTRICAL SERVICE:

1.13.1. N/A

1.13.2. N/A

1.13.3. CONTROLLERS SHALL OPERATE ON SINGLE PHASE, 110 TO 120 VOLT, 60 CYCLE, ALTERNATING CURRENT AND "U.L." LISTED.

1.13.4. CONTROLLERS SHALL BE ENCLOSED IN A U.L. LISTED WEATHERPROOF CORROSION-RESISTANT ENCLOSURE WITH LOCKING COVER.

1.13.5. CONDUIT FOR 120 VOLT AND 24 VOLT WIRING SHALL BE APPROVED BY GOVERNING BUILDING CODES FOR ELECTRICAL SERVICE.

1.14. COMMUNICATION SERVICE:

1.14.1. N/A

1.14.2. POINT OF CONNECTION SHOWN ON PLANS IS APPROXIMATE. CONTRACTOR SHALL COORDINATE WITH OWNER'S AUTHORIZED REPRESENTATIVE TO HAVE COMMUNICATION LINE AVAILABLE WHEN REQUIRED.

1.14.3. N/A

PART 2 – PRODUCTS

2.1. GENERAL:

2.1.1. ALL MATERIALS AND EQUIPMENT SHALL BE PURCHASED NEW, SPECIFICALLY FOR THIS PROJECT, UNLESS OTHERWISE NOTED ON THE PLANS. OF T

2.1.2. THE CONTRACTOR SHALL FURNISH THE ARTICLES, EQUIPMENT, MATERIALS OR PROCESSES SPECIFIED BY NAME IN THE DRAWINGS AND SPECIFICATIONS. NO SUBSTITUTION WILL BE ALLOWED WITHOUT PRIOR WRITTEN APPROVAL BY THE LANDSCAPE ARCHITECT, OR THE OWNER'S AUTHORIZED REPRESENTATIVE.

2.1.3. EQUIPMENT OR MATERIALS INSTALLED OR FURNISHED WITHOUT THE PRIOR APPROVAL OF THE LANDSCAPE ARCHITECT MAY BE REJECTED AND THE CONTRACTOR REQUIRED TO REMOVE AND REPLACE SUCH MATERIALS FROM THE SITE AT HIS OWN EXPENSE.

2.2. BACKFLOW PREVENTION DEVICES:

2.2.1. N/A

2.2.2. N/A

2.2.3. N/A

2.3. PRESSURE REGULATION DEVICES: AS SPECIFIED IN DRAWINGS.

2.4. AUTOMATIC CONTROL SYSTEM: AS SPECIFIED IN DRAWINGS.

2.4.1. CONTRACTOR SHALL FURNISH LOW VOLTAGE SYSTEM MANUFACTURED EXPRESSLY FOR CONTROL OF AUTOMATIC CIRCUIT VALVES OF UNDERGROUND IRRIGATION SYSTEMS. PROVIDE UNIT OF CAPACITY TO SUIT NUMBER OF CIRCUITS AS INDICATED.

2.4.2. MECHANISM SHALL BE HOUSED IN A STURDY, VANDAL-PROOF ENCLOSURE, MANUFACTURED OF 14 GAUGE STEEL OR GAGE ALUMINUM, FURNISHED FOR MAXIMUM PROTECTION, AS CALLED FOR ON THE DRAWINGS (SIZE AS REQUIRED).

2.5. AUTOMATIC CONTROL WIRE: LOW VOLTAGE

2.5.1. DIRECT BURIAL COPPER WIRE AWG-U.F. 600 VOLT, SINGLE CONDUCTOR SOLID COPPER, PLASTIC INSULATED CABLE, U.L. APPROVED FOR DIRECT BURIAL APPLICATION.

2.5.2. AUTOMATIC CONTROL WIRE: LOW VOLTAGE

2.5.2.1. DIRECT BURIAL COPPER WIRE AWG-U.F. 600 VOLT, SINGLE CONDUCTOR SOLID COPPER, PLASTIC INSULATED CABLE, U.L. APPROVED FOR DIRECT BURIAL APPLICATION.

2.5.2.2. FOR TRADITIONAL CONTROL SYSTEMS WITH SINGLE PILOT WIRE TO EACH REMOTE CONTROL VALVE, WIRE SIZE AND COLOR SHALL BE AS FOLLOWS:

WIRE RUN TO 1200"	PILOT WIRE SIZE	COMMON WIRE SIZE
14 GA	12 GA	12 GA
EXCEEDING 1200"	12 GA	12 GA

PILOT WIRES SHALL NOT BE WHITE OR RED AND MUST BE UNIQUE IN COLOR FOR EACH CONTROLLER. COMMON WIRE SHALL BE WHITE WITH COLORED STRIPE EQUAL TO PILOT WIRE COLOR.

CONTROLLER	PILOT	COMMON	SPARE
"A"	BLACK	WHITE W/BLACK STRIPE	RED W/BLACK STRIPE
"B"	BLUE	WHITE W/BLUE STRIPE	RED W/BLUE STRIPE
"C"	YELLOW	WHITE W/YELLOW STRIPE	RED W/YELLOW STRIPE

2.5.2.3. WIRE CONNECTORS FOR SPLICING CONTROL WIRE SHALL BE WATERPROOF, DIRECT BURY, GEL-FILLED OR EPOXY-FILLED SPLICE HOUSING WITH WIRE NUTS OR BRASS CRIMP. WIRE CONNECTOR SHALL BE MODEL DBY AS MANUFACTURED BY THE 3M COMPANY, DS-100 WITH DS-300 FILLER OR DS-400 AS MANUFACTURED BY SPEARS MANUFACTURING COMPANY OR EQUAL.

2.6. FLOW, RAIN, MOISTURE SENSING DEVICES:

2.6.1. ALL SENSING DEVICES SHALL BE AS SPECIFIED IN DRAWINGS.

2.7. MASTER CONTROL / REMOTE CONTROL VALVES: AS SPECIFIED IN DRAWINGS.

2.7.1. VALVES SHALL BE OPERABLE MANUALLY WITHOUT ELECTRICITY BY MEANS OF AN INTERNAL BLEED. THE VALVE SHALL HAVE A PRESSURE REGULATING MODULE CAPABLE OF REGULATING OUTLET PRESSURE BETWEEN 15 AND 100 P.S.I. (+ 5 P.S.I.). MODULE SHALL HAVE AN ADJUSTING SCREW FOR SETTING PRESSURE AND A SCHRADER VALVE CONNECTION FOR MONITORING PRESSURE. PRESSURE REGULATOR SHALL BE ADJUSTED AT EACH VALVE FOR PROPER DOWNSTREAM PRESSURE REQUIRED.

2.8. QUICK COUPLING VALVES:

2.8.1. QUICK COUPLING VALVES SHALL BE 1" SIZE, 2 PIECE BRASS BODY WITH STAINLESS SPRING. AS SPECIFIED ON THE DRAWINGS.

2.8.2. QUICK COUPLING VALVES SERVICING POTABLE WATER IRRIGATION SYSTEMS SHALL ACCEPT A STANDARD BAYONET STYLE KEY. VALVE BODY SHALL BE WITH LOCKING YELLOW RUBBER COVER.

2.8.3. N/A

2.8.3.1. N/A

2.8.4. QUICK COUPLING KEY SHALL BE OF BRASS/BRONZE WITH SWIVEL ASSEMBLY, SUPPLY TWO (2) KEY/SWIVEL ASSEMBLIES FOR EACH TYPE OF QUICK COUPLING VALVE USED.

2.9. BALL VALVES: AS SPECIFIED IN DRAWINGS.

2.10. NON-PRESSURE LATERAL LINE ANTI-DRAIN VALVES:

2.10.1. ANTI-DRAIN VALVES SHALL BE REQUIRED TO PREVENT LOW HEAD DRAINAGE OF IRRIGATION WATER FROM SPRINKLER SYSTEM DUE TO CHANGES IN ELEVATION IN EXCESS OF THE ABILITY OF THE MANUFACTURED IN-HEAD CHECK VALVE.

2.11. MANUAL AND ANTISIPHON VALVES:

2.11.1. MANUAL AND ANTI-SIPHON CONTROL VALVES SHALL BE BRASS OR PLASTIC WITH NON-CORROSIVE INTERNAL PARTS AND CONVERTIBLE TO AUTOMATIC CONTROL. VALVES SHALL BE THE TYPE AND SIZE AS DESIGNATED ON THE DRAWINGS.

2.12. VALVE AND PULL BOXES:

2.12.1. MASTER CONTROL VALVE/PRESSURE REGULATOR ASSEMBLY -SHALL BE AS FOLLOWS:
1" VALVE ASSEMBLY SHALL BE 14"x20"x12" NOMINAL RECTANGULAR JUMBO PLASTIC VALVE BOX AND 6" EXTENSION WITH LOCKABLE GREEN TOP, MANUFACTURED BY ARMOR, PART #190106 AND #190110, OR EQUAL.

1-1/2" AND 2" VALVE ASSEM. SHALL BE 17"x30"x18" NOM. RECT. JUMBO PLASTIC VALVE BOX WITH LOCKABLE GREEN TOP MANUFACTURED BY ARMOR, PART #191013, OR EQUAL.

2.12.2. REMOTE CONTROL VALVE/ BALL VALVE -SHALL BE 10"x16"x12" NOMINAL RECTANGULAR PLASTIC VALVE BOX WITH LOCKABLE GREEN TOP, MANUFACTURED BY ARMOR, PART #170106, OR EQUAL.

2.12.3. REMOTE CONTROL VALVE/PRESSURE REGULATOR ASSEMBLY -SHALL BE 10"x16"x12" NOMINAL RECTANGULAR PLASTIC VALVE BOX WITH LOCKABLE GREEN TOP, MANUFACTURED BY ARMOR, PART #170106, OR EQUAL.

2.12.4. DRIP FILTER/BALL VALVE ASSEMBLY -SHALL BE 14"x19"x12" NOMINAL RECTANGULAR PLASTIC VALVE BOX WITH LOCKABLE GREEN TOP, MANUFACTURED BY ARMOR, PART #190106, OR EQUAL.

2.12.5. QUICK COUPLER VALVES, MULTI-EXIT DRIP EMITTERS, LATERAL LINE BLOW-OUT VALVES -SHALL BE 10" ROUND, PLASTIC VALVE BOX WITH GREEN TOP, MANUFACTURED BY ARMOR, PART #181104, OR EQUAL.

2.12.6. PULL OR SPLICE BOXES -FOR IRRIGATION SYSTEMS SHALL BE PLASTIC VALVE BOX WITH LOCKABLE GREEN TOP, MANUFACTURED BY ARMOR OR EQUAL AS FOLLOWS:
FOR 16 CONTROL WIRES OR LESS -10" ROUND BOX, PART #181104.
FOR MORE THAN 16 CONTROL WIRES OR FOR CONDUITED PULL BOX -10"x16"x12" RECTANGULAR BOX, PART #170106.
PLASTIC VALVE BOX WITH GREEN TOP MANUFACTURED BY ARMOR, PART #181104, OR EQUAL.

2.13. PIPE AND FITTINGS:

2.13.1. POLYVINYL CHLORIDE (PVC) PIPE AND FITTINGS:

2.13.1.1. ALL IRRIGATION PIPING, INSTALLED UNDER THIS DESIGN SHALL BE IDENTIFIED IN ACCORDANCE WITH THE DISTRICT'S STANDARD SPECIFICATIONS.

2.13.1.2. ALL PVC PIPE SHALL BE MADE FROM NSF APPROVED, TYPE I, GRADE II PVC COMPOUND CONFORMING TO ASTM RESIN SPECIFICATION D1784. PIPE SHALL MEET REQUIREMENTS SET FORTH IN FEDERAL SPECIFICATION PS-22-70 WITH AN APPROPRIATE STANDARD DIMENSION RATIO.

2.13.1.3. FURNISH PLASTIC PIPE CONTINUOUSLY AND PERMANENTLY MARKED WITH FOLLOWING INFORMATION: MANUFACTURE'S NAME OR TRADE MARK, SIZE, CLASS AND TYPE OF PIPE, WORKING PRESSURE AT 73.4 DEGREES F., AND NATIONAL SANITATION FOUNDATION (NSF) RATING.

2.13.1.4. ALL PRESSURE SUPPLY LINES LOCATED UPSTREAM OF REMOTE CONTROL VALVES AND QUICK COUPLERS SHALL MEET THE FOLLOWING CRITERIA:

2.13.1.4.1. ALL TWO (2) INCH AND LARGER SIZED PIPE SHALL BE CLASS 315 POLYVINYL CHLORIDE (PVC) WITH A STANDARD DIMENSION RATIO (SDR) OF 13.5, CONFORMING TO ASTM RESIN SPECIFICATION D1784 AND PRODUCT DESIGN SPECIFICATION ASTM D2241.

2.13.1.4.2. ALL ONE AND ONE-HALF (1-1/2) INCH AND SMALLER SIZED PIPE SHALL BE SCHEDULE 40 POLYVINYL CHLORIDE (PVC) CONFORMING TO ASTM RESIN SPECIFICATION D1784 AND PRODUCT DESIGN SPECIFICATION ASTM D1785.

2.13.1.5.1. ALL NON-PRESSURE DISTRIBUTION (LATERAL) LINES LOCATED DOWNSTREAM OF REMOTE CONTROL VALVES SHALL BE SCHEDULE 40 POLYVINYL CHLORIDE (PVC) CONFORMING TO ASTM RESIN SPECIFICATION D1784 AND PRODUCT DESIGN SPECIFICATION ASTM D1785.

2.13.1.5.2. MINIMUM LATERAL LINE PIPE SIZE IS 3/4". 1/2" DIAMETER PIPE IS NOT PERMITTED.

2.13.1.6. NO CLOSE NIPPLES SHALL BE USED.

2.13.1.7. ALL IRRIGATION PIPING SHALL BE WHITE PVC.

2.13.1.8. POLYVINYL CHLORIDE PIPE FITTINGS AND CONNECTIONS SHALL BE PRODUCED FROM TYPE I, GRADE I, POLYVINYL CHLORIDE CONFORMING TO ASTM RESIN SPECIFICATION D1784. FITTINGS SHALL BE HIGH IMPACT MOLDED FITTINGS, MANUFACTURED FROM VIRGIN COMPOUNDS AS SPECIFIED FOR PIPING TAPERED SOCKET OR MOLDED THREAD TYPE, SUITABLE FOR EITHER SOLVENT WELD OR SCREWED CONNECTIONS. MACHINE THREADED FITTINGS AND PLASTIC SADDLE AND FLANGE FITTINGS ARE NOT ACCEPTABLE. FURNISH FITTINGS PERMANENTLY MARKED WITH THE FOLLOWING INFORMATION: NOMINAL PIPE SIZE, TYPE AND SCHEDULE OF MATERIAL, AND NATIONAL SANITATION FOUNDATION (NSF) SEAL OF APPROVAL.

2.13.1.9.1. FITTINGS FOR PRESSURE SUPPLY LINES LOCATED UPSTREAM OF REMOTE CONTROL VALVES AND QUICK COUPLERS SHALL MEET THE FOLLOWING CRITERIA: FITTINGS SHALL BE SCHEDULE 80 SOCKET AND/OR THREADED TYPE CONFORMING PRODUCT DESIGN SPECIFICATION ASTM D2467.

2.13.1.9.2. FITTINGS FOR NON-PRESSURE DISTRIBUTION LINES LOCATED DOWNSTREAM OF REMOTE CONTROL VALVES SHALL MEET THE FOLLOWING CRITERIA: FITTINGS SHALL BE SCHEDULE 40 SOCKET AND/OR THREADED TYPE CONFORMING PRODUCT DESIGN SPECIFICATION ASTM D2466.

2.13.1.10. SLEEVES SERVICING WATER LINES AND ELECTRICAL CONDUIT SHALL BE SCHEDULE 40 POLYVINYL CHLORIDE (PVC) CONFORMING TO ASTM RESIN SPECIFICATION D1784 AND PRODUCT DESIGN SPECIFICATION ASTM D1785.

2.13.1.11. SOLVENT CEMENTS SHALL COMPLY WITH ASTM D2564. SOCKET JOINTS SHALL BE MADE PER RECOMMENDED PROCEDURES FOR JOINING PVC PLASTIC PIPE AND FITTINGS WITH PVC SOLVENT CEMENT BY THE PIPE AND FITTING MANUFACTURER AND PROCEDURES OUTLINED IN THE APPENDIX OF ASTM D2564.

2.13.1.12. THREAD LUBRICANT SHALL BE TEFLON RIBBON-TYPE, OR APPROVED EQUAL, SUITABLE FOR THREADED INSTALLATIONS AS PER MANUFACTURER'S RECOMMENDATIONS.

2.13.2. METALLIC PIPE AND FITTINGS

2.13.2.1. COPPER PIPE SHALL BE TYPE K HARD COPPER. FOR PLUMBING INSTALLATIONS BETWEEN THE WATER METER AND THE BACKFLOW PREVENTION DEVICE AS REQUIRED BY THE DISTRICT.

2.13.2.2. FITTINGS FOR COPPER TUBING SHALL MEET ANSI B 16.22 WROUGHT COPPER OR CAST BRASS, RECESSED SOLDER JOINT TYPE FITTINGS.

2.13.2.3. BRASS PIPE SHALL BE IPS STANDARD WEIGHT 125 POUNDS, 85% RED BRASS.

2.13.2.4. BRASS FITTINGS SHALL BE STANDARD 125 POUND CLASS 85% RED BRASS FITTINGS AND CONNECTIONS.

2.13.2.5. GALVANIZED STEEL PIPE SHALL BE SCHEDULE 40 ASTM, 120-GIP THREADED, COUPLED AND HOT-DIP GALVANIZED.

2.13.2.6. GALVANIZED STEEL FITTINGS SHALL BE HEAVY PATTERN, BANDED, GALVANIZED MALLEABLE IRON.

2.14. CONCRETE THRUST BLOCK AND SUPPORTS:

2.14.1. ALL CONCRETE WORK SHALL BE 2,000 PSI MINIMUM COMPRESSIVE STRENGTH AT TWENTY-EIGHT (28) DAYS, 5 SACK MIX, TOOL FINISHED ON EXPOSED SURFACES.

2.15. IDENTIFICATION TAPE:

2.15.1. MARKER TAPE SHALL BE 5 MIL POLYETHYLENE, 3" WIDE WITH A 20 GAUGE SOLID ALUMINUM FOIL CORE AS MANUFACTURED BY T. CHRISTY ENTERPRISES AT (800) 258-4583. FURTHER MARKING TAPE SHALL MEET THE FOLLOWING CRITERIA:

2.15.1.1. FOR CONSTANT PRESSURE LINES OF SYSTEMS CONNECTED TO A POTABLE WATER SOURCE, TAPE SHALL BE BLUE IN COLOR WITH THE WORDS, "CAUTION WATER LINE BURIED BELOW" IN 1" HIGH BLACK LETTERS. MODEL NUMBER TA-DT-03-BW OR EQUAL.

2.15.1.2. FOR CONTROL WIRE NOT INSTALLED WITH A CONSTANT PRESSURE LINE, TAPE SHALL BE RED IN COLOR WITH THE WORDS, "CAUTION ELECTRICAL LINE BURIED BELOW" IN 1" HIGH BLACK LETTERS. MODEL NUMBER TA-DT-03-RE OR EQUAL.

2.16. WARNING AND VALVE/STATION IDENTIFICATION TAGS:

2.16.1. VALVE/STATION IDENTIFICATION TAGS SHALL BE WEATHERPROOF PLASTIC 3" X 4", WITH CONTROLLER AND STATION NUMBER PRINTED IN 1-1/8" HIGH BLACK LETTERS. TAGS SHALL BE MODEL #D-STD-P1 AS MANUFACTURED BY T. CHRISTY ENTERPRISES, OR EQUAL.

2.16.2. VALVE/STATION IDENTIFICATION TAGS FOR POTABLE WATER SYSTEMS SHALL BE WEATHERPROOF PLASTIC 3" X 4", YELLOW IN COLOR WITH WORDS IN BLACK LETTERS READING, "POTABLE WATER USED FOR IRRIGATION - DO NOT DRINK" (PRINTED ON ONE SIDE. ON THE BLANK SIDE THE CONTRACTOR SHALL PROVIDE THE CONTROLLER AND STATION NUMBER IN 1" HIGH, BLACK LETTERS/NUMBERS USING PERMANENT WEATHERPROOF INK. TAGS SHALL BE MODEL #D-MAX-Y2-PW016 AS MANUFACTURED BY T. CHRISTY ENTERPRISES, OR EQUAL.

2.16.3. WEATHERPROOF BLACK INK MARKER TO BE MODEL # 10-TAGPEN AS MANUFACTURED BY T. CHRISTY ENTERPRISES, OR EQUAL.

2.17. SPRINKLERS:

2.17.1. SPRINKLER HEADS SHALL BE OF THE TYPES AND SIZES WITH DIAMETER (OR RADIUS) OF THROW, PRESSURE, NOZZLE DISCHARGE AND/OR OTHER DESIGNATIONS INDICATED ON THE DRAWINGS.

2.17.2. ALL SPRINKLER HEADS OF THE SAME TYPE AND SIZE SHALL BE OF THE SAME MANUFACTURER. HEADS SHALL BE EQUIPPED WITH ALL OPTIONS AND EQUIPMENT PER THE IRRIGATION LEGEND.

2.17.3. ALL SPRINKLER HEADS SHALL BE EQUIPPED WITH A MANUFACTURER INSTALLED INTERNAL CHECK VALVE, WHEN AVAILABLE.

2.17.4. N/A

2.18. DRIP IRRIGATION EQUIPMENT: See Legend and Notes.

2.18.1. PRESSURE GAGES: ASME B40.1 PRESSURE GAGE, INCLUDE 4-1/2-INCH-(115-MM-) DIAMETER DIAL, RANG OF TWO TIMES SYSTEM OPERATING PRESSURE, AND BOTTOM OUTLET.

2.18.2. APPLICATION PRESSURE REGULATORS: PRESSURE REGULATING VALVE FOR DRIP SYSTEMS SHALL BE A PRESET DEVICE FOR THE DESIGN FLOWS. PRESSURE REGULATING VALVE SHALL BE AS SPECIFIED IN THE IRRIGATION LEGEND AND SIZED ACCORDING TO NOTES IN THE DETAIL AND DRAWING.

2.18.3. STRAINER/FILTER UNITS: SCREEN FILTER FOR DRIP SYSTEMS SHALL BE A STAINLESS STEEL SCREEN ELEMENT WITH COLOR-CODED END SEALS INDICATING MESH SIZE (ALL FILTERS TO HAVE BLACK ELEMENTS INDICATING 150 MESH). SCREEN FILTER SHALL BE SIZED ACCORDING TO NOTES IN THE DETAIL DRAWINGS.

2.18.4. DRIP EMITTERS: EMITTERS SHALL BE PRESSURE COMPENSATING, MULTI-EXIT TYPE AS LISTED IN THE LEGEND AND AS MANUFACTURED BY THE RAINBIRD CORP.

2.18.4. DISTRIBUTION TUBING: TUBING FOR PLACEMENT OF EACH EMISSION POINT SHALL BE 1/4" FLEXIBLE POLYETHYLENE MANUFACTURED SPECIFICALLY FOR THE SPECIFIED DRIP EMITTERS. TUBING SHALL BE MODEL # PT-025 AS MANUFACTURED BY THE RAINBIRD CORP.

2.18.6. DRIP LATERAL BLOW-OUT: ALL DRIP SYSTEMS SHALL INCLUDE MANUAL FLUSH VALVES AT THE ENDS OF EACH INDEPENDENT ZONE, OR SEPARATE LEG OF EACH ZONE. BLOW-OUT VALVES SHALL BE SUITED CONTRACTOR FABRICATED AS DETAILED.

2.19. N/A

2.19.1. N/A

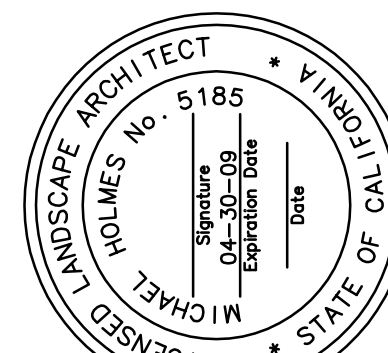

PINNACLE Civil Engineering, Inc.
 2161 Saturn Court, Bakersfield, CA 93308
 Phone: (661) 869-0184 Fax: (661) 377-0076

MICHAEL HOLMES	LA 5185 EXP. 4/30/09	DATE
REVISIONS		7-14-09
DELETED NORTH PORTION OF SITE SPECIFIED TREES AND IRRIGATION COMPONENTS		

IRRIGATION SPECIFICATIONS
 BCSD - WAYSIDE ELEMENTARY
 IRRIGATION

PART 3 – EXECUTION

3.1. GENERAL:

3.1.1. PLANS ARE DIAGRAMMATIC. ALL PIPING, VALVE BOXES, AND ASSOCIATED EQUIPMENT SHALL BE LOCATED IN LANDSCAPE AREAS. NO IRRIGATION EQUIPMENT SHALL BE LOCATED IN HARDSCAPE. GROUP VALVE BOXES TOGETHER AND LOCATE IN SHRUB AREAS, WHENEVER POSSIBLE.

3.1.2. UNLESS OTHERWISE INDICATED, COMPLY WITH REQUIREMENTS OF UNIFORM PLUMBING CODE.

3.1.3. PLANT MATERIAL 24" BOX SIZE AND LARGER SHALL BE PLANTED PRIOR TO THE INSTALLATION OF IRRIGATION PIPING.

3.1.4. VERIFY WATER PRESSURE AT EACH POINT OF CONNECTION PRIOR TO INITIATING WORK. NOTIFY THE OWNER'S AUTHORIZED REPRESENTATIVE IF PRESSURE IS LESS THAN INDICATING ON DRAWINGS. CONTRACTOR IS RESPONSIBLE FOR ALL FIELD REVISIONS IF OWNER'S AUTHORIZED REPRESENTATIVE IS NOT INFORMED OF DISCREPANCIES.

3.1.5. CONNECT TO EXISTING STREET SERVICE LINE AT LOCATION INDICATED.

3.1.6. SYSTEM DESIGN:

3.1.6.1. ALL SCALED DIMENSIONS ARE APPROXIMATE. THE CONTRACTOR SHALL CHECK AND VERIFY ALL DIMENSIONS ON THE SITE PRIOR TO PROCEEDING WITH WORK UNDER THIS CONTRACT.

3.1.6.2. THE CONTRACTOR SHALL LOCATE AND MARK ALL EXISTING UTILITIES SUCH AS POWER, TELEPHONE, DOMESTIC WATER, WATER, AND TILE DRAINS. EXTREME CARE SHALL BE TAKEN BY THE CONTRACTOR WHEN EXCAVATING OR WORKING IN THESE AREAS AND COORDINATION AND COOPERATION BETWEEN THE OWNER'S REPRESENTATIVE AND THE CONTRACTOR IS REQUIRED AS THE WORK PROGRESSES TO THE AREA. CONTRACTOR SHALL GIVE 24 HOURS NOTICE TO REPRESENTATIVE AS WORK PROGRESSES TO UNDERGROUND UTILITY AREAS. CONTRACTOR SHALL BE RESPONSIBLE FOR DAMAGE TO ANY UTILITIES.

3.1.6.3. SHOULD UTILITIES NOT LOCATED OR MARKED BE FOUND DURING EXCAVATION, THE CONTRACTOR SHALL PROMPTLY NOTIFY THE OWNER AND SHALL DISCONTINUE WORK IN THE AREA, EXCEPT NECESSARY EMERGENCY WORK, TO REPAIR OR PREVENT DAMAGE UNTIL INSTRUCTIONS ARE GIVEN TO THE CONTRACTOR BY THE OWNER'S REPRESENTATIVE.

3.1.6.4. FAILURE TO NOTIFY THE OWNER OF DISCOVERY OF SUCH UTILITIES OR DAMAGE THERETO WILL RESULT IN THE CONTRACTOR BEING LIABLE FOR ANY AND ALL DAMAGE CAUSED TO THE UTILITIES AS A RESULT OF HIS ACTIONS.

3.1.6.5. THE CONTRACTOR SHALL, BEFORE STARTING WORK ON THE SPRINKLER SYSTEM, CAREFULLY NOTE ALL FINISH GRADES IN ORDER TO SATISFY HIMSELF THAT HE MAY PROCEED WITH THE WORK, AND TO RESTORE FINISH GRADES TO ORIGINAL CONTOURS BEFORE COMPLETION.

3.1.6.6. THE INSTALLATION OF ALL SPRINKLER MATERIALS, INCLUDING PIPE, SHALL BE COORDINATED WITH THE LANDSCAPE DRAWINGS TO AVOID INTERFERING WITH THE TREES, SHRUBS, OR OTHER PLANTING.

3.1.6.7. LAY OUT SPRINKLER HEADS AND MAKE ANY MINOR ADJUSTMENTS REQUIRED DUE TO DIFFERENCE BETWEEN SITE AND DRAWINGS. ANY SUCH DEVIATIONS IN LAYOUT SHALL BE WITHIN THE INTENT OF THE ORIGINAL DRAWINGS, AND WITHOUT ADDITIONAL COST TO THE OWNER. WHEN DIRECTED BY THE OWNER, THE LAYOUT SHALL BE APPROVED BEFORE INSTALLATION.

3.1.6.8. DO NOT WILLFULLY INSTALL THE SPRINKLER SYSTEM AS INDICATED ON THE DRAWINGS WHEN IT IS OBVIOUS IN THE FIELD THAT PREVIOUSLY UNKNOWN OBSTRUCTIONS OR DIFFERENCES EXIST THAT MIGHT NOT HAVE BEEN CONSIDERED IN THE ENGINEERING. SUCH OBSTRUCTIONS OR DIFFERENCES SHOULD BE BROUGHT TO THE ATTENTION OF THE LANDSCAPE ARCHITECT.

3.1.6.9. THE CONTRACTOR SHALL CONNECT TO THE WATER SOURCE AS INDICATED ON THE DRAWINGS. THE CONTRACTOR SHALL VERIFY STATIC PRESSURE AS STATED ON THE PLANS PRIOR TO BEGINNING WORK. IF STATIC PRESSURE OR POINT OF CONNECTION DIFFER FROM THAT SHOWN ON THE PLANS, THE CONTRACTOR WILL PROMPTLY NOTIFY LANDSCAPE ARCHITECT BEFORE STARTING WORK.

3.1.6.10. THE ROUTING OF THE PRESSURE SUPPLY LINES AS INDICATED ON THE DRAWINGS IS DIAGRAMMATIC. LOCATE ALL PRESSURE SUPPLY LINES IN PLANTING AREAS, CROSS PERPENDICULAR UNDER PAVEMENT IN A SLEEVE AS DESCRIBED IN THESE SPECIFICATIONS.

3.2. BACKFLOW PREVENTER:

3.2.1. BACKFLOW PREVENTER ASSEMBLY SHALL BE INSTALLED IN ACCORDANCE WITH MANUFACTURER'S SPECIFICATIONS, LOCATED AND AS DIRECTED ON DRAWINGS ADJACENT TO THE POINT OF CONNECTION, AND SHALL CONFORM TO ALL APPLICABLE HEALTH CODE AND ORDINANCE REQUIREMENTS.

3.2.2. BACKFLOW PREVENTER ASSEMBLIES SHALL BE LOCATED IN SHRUB AREAS WHERE POSSIBLE. EXACT LOCATION AND POSITIONING SHALL BE VERIFIED ON THE SITE AND SHALL BE APPROVED BY THE DISTRICT.

3.2.3. BACKFLOW PREVENTER ASSEMBLIES FOR POTABLE WATER IRRIGATION SYSTEMS SHALL BE PAINTED FLAT BLACK.

3.2.4. BACKFLOW PREVENTER ASSEMBLIES FOR POTABLE RECYCLED WATER IRRIGATION SYSTEMS SHALL BE PAINTED PURPLE.

3.3. PRESSURE REGULATION DEVICES:

3.3.1. PRESSURE REGULATION DEVICES SHALL BE INSTALLED AS DIRECTED BY THE PLANS AND DETAILED DRAWINGS.

3.4. AUTOMATIC CONTROL SYSTEM:

3.4.1. AUTOMATIC CONTROLLER SHALL BE INSTALLED AS SHOWN AND AS DIRECTED. FINAL LOCATION SHALL BE APPROVED BY THE LANDSCAPE ARCHITECT PRIOR TO INSTALLATION. CONTROLLER SHALL BE TESTED WITH COMPLETE ELECTRICAL CONNECTIONS. THE CONTRACTOR SHALL BE RESPONSIBLE FOR POWER TO THE CONTROLLER FOR OPERATION AND TESTING PURPOSES.

3.4.2. CONNECTIONS TO CONTROL WIRING SHALL BE MADE WITH AUTOMATIC CONTROLLER ENCLOSURE. ALL WIRE SHALL FOLLOW THE PRESSURE MAIN INSOFAR AS POSSIBLE.

3.4.3. ELECTRICAL WIRING FOR 120 VAC POWER SHALL BE WITHIN A RIGID PVC PLASTIC CONDUIT FROM CONTROLLER TO ELECTRICAL OUTLET. THE ELECTRICAL CONTRACTOR SHALL BE RESPONSIBLE FOR INSTALLING ALL WIRING TO THE SUB-PANELS, CLOCKS, OR ELSEWHERE AS REQUIRED, IN ORDER TO COMPLETE THIS INSTALLATION. A DISCONNECT SWITCH SHALL BE INCLUDED.

3.4.4. CONTROLLERS SHALL HAVE A MASTER SWITCH. IT SHALL BE POSSIBLE TO OPERATE EACH VALVE MANUALLY INDEPENDENT OF THE CLOCK OR ANY OTHER VALVE.

3.4.5. CONTRACTOR SHALL SUPPLY AND INSTALL A MANUFACTURER APPROVED BATTERY IN CONTROLLER TO PREVENT LOSS OF PROGRAM.

3.4.6. CONTROL SYSTEM SHALL BE PROGRAMMED TO OPERATE ONE SYSTEM AT A TIME.

3.4.7. SYSTEM ENCLOSURES SHALL BE EQUIPPED WITH A AUTOMATIC RAIN SHUT-OFF DEVICE.

3.4.8. PRIOR TO SUBSTANTIAL COMPLETION OF PROJECT INSTALLATION, UNITED GREENTECH AND/OR THE CONTROLLER MANUFACTURER WILL TEST THE CONTROLLER, INCLUDING A TEST FROM A REMOTE LOCATION, TO ENSURE THAT IT IS IN FULL WORKING ORDER AND ISSUE THE CITY OF CHULA VISTA WITH A CERTIFICATE STATING THAT THIS TEST HAS BEEN SUCCESSFULLY COMPLETED. THE TEST SHALL BE REPEATED AT THE END OF THE DEVELOPERS ONE YEAR MAINTENANCE PERIOD.

3.4.8.1. FOR TECHNICAL ASSISTANCE DURING INSTALLATION CONTACT: KERN TURF (661) 978-5325. CONTROLLER MANUFACTURER – RAINBIRD (626)812-3400

3.4.8.2. FOR CERTIFICATION AND PROJECT TURN-OVER CONTACT: KERN TURF (661) 978-5325. CONTROLLER MANUFACTURER – RAINBIRD (626)812-3400

3.5. AUTOMATIC CONTROL WIRE:

3.5.1. INSTALL CONTROL WIRES WITHIN PVC SCH 40 ELECTRICAL CONDUIT FROM THE CONTROLLER TO ALL REMOTE CONTROL VALVES. CONTROL WIRE CONDUIT SHALL BE ROUTED WITH THE IRRIGATION MAINLINE PIPING IN COMMON TRENCHES WHEREVER POSSIBLE. PROVIDE A MINIMUM OF 4" FROM MAINLINE PIPE OR FITTINGS EXCEPT AT TERMINAL POINTS.

3.5.2. WHEN NOT ROUTED WITH MAINLINE, INSTALL CONTROL WIRE CONDUIT AT LEAST 18" BELOW FINISH GRADE.

3.5.3. CONDUIT TO RUN THROUGH SLEEVES SHOWN ON THE DRAWINGS. PULL BOXES SHOWN AT CROSSINGS OF VEHICULAR PAVING ARE TO BE USED AS HAND-HOLES AND/OR SPLICE LOCATIONS. CONTROL WIRE CONDUIT TO BE SEPARATE FROM WATER LINES AND 120V ELECTRICAL SERVICE LINE.

3.5.4. ALL SPLICES, WHEN APPROVED FOR USE, SHALL BE ENCASED IN PRE-APPROVED WATERPROOF CONNECTORS.

3.5.5. END OF SPARE WIRES SHALL BE ENCASED IN A WATERPROOF CONNECTOR.

3.5.6. FOR TRADITIONAL CONTROL SYSTEMS WITH SINGLE PILOT WIRE TO EACH REMOTE CONTROL VALVE THE FOLLOWING SHALL APPLY:

3.5.6.1. PROVIDE ONE CONTROL WIRE AND THE COMMON GROUND WIRE TO SERVICE EACH VALVE IN SYSTEM. PROVIDE 4 FOOT MINIMUM EXPANSION LOOP AT EACH VALVE TO PERMIT REMOVAL AND MAINTENANCE OF VALVES.

3.5.6.2. CONTINUOUS WIRE RUNS SHALL NOT BE LESS THAN 500 FEET IN LENGTH. THERE SHALL BE NO SPLICES ON WIRE RUNS LESS THAN 500 FT.

3.5.6.3. SPLICE/CONNECTIONS SHALL BE WITH APPROVED DEVICES AND INSTALLED PER THE MANUFACTURER'S DIRECTIONS.

3.5.6.4. IN CASE OF DAMAGE TO ANY COMMON OR CONTROL WIRE, CONTRACTOR IS TO RUN AN EXTRA COMMON AND TWO EXTRA CONTROL WIRES ON EACH LEG OF MAINLINE TO THE FARTHEST RCV BACK TO THE CONTROLLER.

3.5.6.5. IDENTIFY DIRECT BURIAL CONDUIT WIRES FROM AUTOMATIC VALVES TO TERMINAL STRIPS OF CONTROLLER AT TERMINAL STRIP BY TAGGING WIRE WITH NUMBER OF CONNECTED VALVES.

3.5.7. N/A

3.5.7.1. N/A

3.5.7.2. N/A

3.5.7.3. N/A

3.5.7.4. N/A

3.6. FLOW, RAIN, MOISTURE SENSING DEVICE:

3.6.1. ALL SENSING DEVICES SHALL BE LOCATED AND/OR ARRANGED APPROXIMATELY AS INDICATED ON PLANS AND SUBJECT TO FIELD APPROVAL BY THE LANDSCAPE ARCHITECT.

3.6.1.1. IN GENERAL LOCATIONS SHALL BE AS FOLLOWS: FLOW SENSING – LOCATED DOWNSTREAM OF MASTER CONTROL VALVE ON COMMON MAINLINE SECTION. RAIN SENSING – LOCATED TO PROVIDE A CLEAR VIEW OF THE SKY AND WHERE IT WILL NOT BE AFFECTED BY SPRAY FROM AN IRRIGATION SYSTEM. MOISTURE SENSING – LOCATED IN REPRESENTATIVE HYDROZONE WITHIN ROOTED SOIL PROFILE.

3.6.2. ALL SENSING DEVICE SHALL BE INSTALLED PER MANUFACTURE'S DIRECTIONS, INSTRUCTIONS AND SPECIFICATIONS.

3.6.3. EACH CONTROLLER ASSEMBLY SHALL BE EQUIPPED WITH ITS OWN RAIN SENSING DEVICE, UNLESS SYSTEM IS OPERATED BY A CENTRAL CONTROL SYSTEM.

3.6.3. EACH CONTROLLER ASSEMBLY SHALL BE EQUIPPED WITH ITS OWN FLOW SENSING DEVICE.

3.7. MASTER CONTROL / REMOTE CONTROL VALVE:

3.7.1. LOCATE AND INSTALL IN SHRUB AREAS, AT APPROXIMATE LOCATIONS AS SHOWN ON THE DRAWINGS.

3.7.2. INSTALLATION SHALL INCLUDE A PVC OR BRASS UNION ON THE DOWNSTREAM SIDE OF THE VALVE. ALL CONNECTIONS TO VALVES SHALL BE MADE HORIZONTALY.

3.7.3. LOCATE MASTER CONTROL VALVE ON COMMON MAINLINE SECTION DOWNSTREAM OF THE BACKFLOW PREVENTION EQUIPMENT AND UPSTREAM OF THE FLOW SENSING DEVICE.

3.7.4. WHERE POSSIBLE, VALVES SHALL BE GROUPED TOGETHER IN A MANIFOLD DOWNSTREAM OF A MANIFOLD ISOLATION VALVE AS DETAILED AND SHOWN ON THE PLANS.

3.8. QUICK COUPLING VALVES:

3.8.1. WHERE POSSIBLE, INSTALL QUICK COUPLING VALVES IN SHRUB AREAS, AT APPROXIMATE LOCATIONS AS SHOWN ON THE DRAWINGS.

3.8.2. QUICK COUPLING VALVES SHALL BE INSTALLED WITHIN A VALVE BOX AS DETAILED AND SPECIFIED IN PART 2. VALVE AND BOX SHALL BE LOCATED TO ALLOW APPROXIMATELY 12 INCH CLEARANCE FROM VALVE BOX TO PAVING, WALKS, HEADERS OR CURBS, AND AS SHOWN ON PLANS AND AS DIRECTED.

3.8.3. QUICK COUPLING VALVES ON RECYCLED WATER SYSTEMS MUST BE SUCH THAT ACCESS AND OPERATION CAN BE ACCOMPLISHED ONLY WITH A SPECIAL ACME THREADED KEY.

3.9. BALL VALVES:

3.9.1. WHERE POSSIBLE, INSTALL BALL VALVES IN SHRUB AREAS, AT APPROXIMATE LOCATIONS AS SHOWN ON THE DRAWINGS.

3.9.2. BALL VALVES SHALL BE INSTALLED TO ISOLATE INDIVIDUAL VALVES OR VALVE MANIFOLDS AND/OR SECTIONS OF THE IRRIGATION MAINLINE.

3.9.3. BALL VALVES SHALL BE INSTALLED TO SECTION THE IRRIGATION MAINLINE INTO MANAGEABLE AREAS, TO LIMIT DRAINING OF MAINLINE DURING REPAIRS.

3.10. NON-PRESSURE LATERAL LINE ANTI DRAIN VALVES:

3.10.1. PROVIDE MANUFACTURER'S INSTALLED ANTI-DRAIN VALVES IN ALL POP-UP SPRINKLER HEADS.

3.10.2. WHERE MANUFACTURER'S INSTALLED ANTI-DRAIN VALVES ARE NOT AVAILABLE INSTALL ANTI-DRAIN VALVES ON POP-UP SPRINKLERS SWING JOINT ASSEMBLY OR BELOW THE HEAD FOR SHRUB HEADS ON RISERS.

3.10.3. ADDITIONAL IN-LINE ANTI-DRAIN VALVES SHALL BE INSTALLED WHEREVER NECESSARY TO PREVENT LOW HEAD DRAINAGE AFTER THE SYSTEM IS SHUT OFF.

3.11. MANUAL AND ANTISIPHON VALVES:

3.11.1. MANUAL AND ANTI-SIPHON CONTROL VALVES SHALL BE INSTALLED AS DIRECTED BY THE PLANS AND DETAIL DRAWINGS.

3.11.1. MANUAL AND ANTI-SIPHON CONTROL VALVES SHALL BE LOCATED IN INCONSPICUOUS LOCATION AS APPROVED BY THE OWNER'S REPRESENTATIVE.

3.12. VALVE AND PULL BOXES:

3.12.1. INSTALL NO MORE THAN ONE VALVE PER BOX.

3.12.2. VALVE BOXES SHALL BE INSTALLED ADJACENT TO PAVED SURFACES WITH CLEARANCE AS DETAILED, WHERE POSSIBLE.

3.12.3. VALVE BOXES SHALL BE SET AT HEIGHTS AS FOLLOWS: IN SHRUB AREAS – TOP OF COVER SET ONE INCH ABOVE FINISH GRADE. IN TURF AREAS – TOP OF COVER SET ONE-HALF INCH ABOVE OR EVEN WITH FINISH GRADE. IN ALL CONDITIONS – TOP OF COVER SET NO HIGHER THAN ADJACENT PAVING SURFACE.

3.12.4. ON THE INSIDE SURFACE OF EACH REMOTE CONTROL VALVE BOX, PULL BOX AND QUICK COUPLING BOX, WRITE THE VALVE DESIGNATION NUMBER IN PERMANENT BLACK MARKER OR PAINT. DO NOT WRITE ON VALVE BOX LID.

3.12.5. ALL VALVE BOX LIDS SHALL MARKED TO IDENTIFY INCLUDED EQUIPMENT AS SHOWN IN THE VALVE BOX I.D. DETAIL DRAWING.

3.12.6. IN ADDITION TO THE "PB" IDENTIFICATION FOR A PULL BOX, WHERE PULL BOXES ARE LOCATED AT STREET CROSSINGS, THE CONTRACTOR SHALL STAMP OR ETCH THE LETTER "E" INTO THE IMPROVEMENT DIRECTLY OVER THE SLEEVE.

3.13. INSTALLATION OF PIPE:

3.13.1. INSTALLATION OF POLYNYL CHLORIDE PIPE:

3.13.1.1. BECAUSE OF THE FRAGILE NATURE OF PLASTIC PIPE AND FITTINGS, EXERCISE CAUTION IN HANDLING, LOADING AND STORING, TO AVOID DAMAGE.

3.13.1.2. THE PIPE AND FITTINGS SHALL BE STORED UNDER COVER UNTIL USED AND SHALL BE TRANSPORTED IN A VEHICLE WITH A BED LONG ENOUGH TO ALLOW THE LENGTH OF PIPE TO LAY FLAT SO AS NOT BE SUBJECTED TO UNDUCE BENDING OR CONCENTRATED EXTERNAL LOAD AT ANY POINT.

3.13.1.3. ANY PIPE THAT HAS BEEN DENTED OR DAMAGED SHALL BE DISCARDED UNLESS SUCH DENT OR DAMAGED SECTION IS CUT OUT AND PIPE REJOINED WITH A COUPLING.

3.13.1.4. TRENCH DEPTH SHALL BE AS SPECIFIED ABOVE FROM THE FINISH GRADE TO THE TOP OF THE PIPE. THE BOTTOM OF THE TRENCH SHALL BE FREE OF ROCKS, CLODS, AND OTHER SHARP-EDGED OBJECTS.

3.13.1.5. PIPE ENDS AND FITTINGS SHALL BE WIPED WITH "MEK" PRIMER, OR APPROVED EQUAL, BEFORE WELDING SOLVENT IS APPLIED. WELDED JOINTS SHALL BE GIVEN A MINIMUM OF 15 MINUTES TO SET BEFORE MOVING OR HANDLING. ALL FIELD CUTS SHALL BE BEVELED TO REMOVE BURRS AND EXCESS MATERIAL BEFORE FITTING AND GLUING TOGETHER.

3.13.1.6. PIPE SHALL BE SNAKED FROM SIDE-TO-SIDE OF TRENCH BOTTOM TO ALLOW FOR EXPANSION AND CONTRACTION.

3.13.1.7. CENTER LOAD PIPE WITH SMALL AMOUNT OF BACKFILL TO PREVENT ARCHING AND SLIPPING UNDER PRESSURE. LEAVE JOINTS EXPOSED FOR SITE OBSERVATION DURING TESTING.

3.13.1.8. NO WATER SHALL BE PERMITTED IN THE PIPE UNTIL SITE OBSERVATION HAS BEEN COMPLETED AND A PERIOD OF AT LEAST 24 HOURS HAS ELAPSED FOR SOLVENT WELD SETTING AND CURING.

3.13.1.9. PLASTIC TO METAL JOINTS SHALL BE MADE WITH PLASTIC MALE ADAPTERS, METAL NIPPLE HAND TIGHTENED, PLUS ONE TURN WITH A STRAP WRENCH.

3.13.1.10. PLASTIC TO PLASTIC JOINTS: SOLVENT-WELD, USING SOLVENT RECOMMENDED BY PIPE MANUFACTURER ONLY.

3.13.1.11. SOLVENT-WELD JOINTS: ASSEMBLE PER MANUFACTURER'S RECOMMENDATIONS.

3.13.1.12. PROVIDE MINIMUM OF 6" OF CLEARANCE BETWEEN PIPES SHARING THE SAME TRENCH.

3.13.1.13. ALL SLEEVES FOR INSTALLATION OF PIPE, WIRE OR WIRE CONDUIT UNDER PAVING SHALL RUN CONTINUOUSLY UNDER THE PAVED AREA AND EXTEND A MINIMUM OF 12 INCHES PAST EDGE OF HARDSCAPE. SEE DETAIL DRAWINGS.

3.13.2. METALLIC PIPE:

3.13.2.1. CUT BY POWER HACKSAW, CIRCULAR CUTTING MACHINE USING AN ABRASIVE WHEEL, OR HAND HACKSAW. CUT NO PIPING WITH METALLIC WHEEL CUTTER OF ANY DESCRIPTION. REAM AND REMOVE ROUGH EDGES OF BURRS SO SMOOTH AND UNOBSTRUCTED FLOW IS OBTAINED.

3.13.2.2. CAREFULLY AND SMOOTHLY PLACE THREAD LUBRICANT ON MALE THREAD ONLY. TIGHTEN SCREWED JOINTS WITH TONGS OR WRENCHES. CAULKING IS NOT PERMITTED.

3.13.2.3. USE DIELECTRIC FITTINGS AT CONNECTION WHERE PIPES OF DISSIMILAR METAL ARE JOINED.

3.13.3. EXCAVATION OF TRENCHES:

3.13.3.1. EXCAVATE TRENCHES, PREPARE SUBGRADE, AND BACKFILL TO LINE AND GRADE WITH SUFFICIENT ROOM FOR PIPE FITTINGS, TESTING AND INSPECTING OPERATIONS. DO NOT BACKFILL UNTIL THE PIPE SYSTEM HAS BEEN SUBJECTED TO A HYDROSTATIC TEST AS SPECIFIED.

3.13.3.2. TRENCH DEPTH, MEASURED FROM FINISH GRADE TO TOP OF PIPE, FOR IRRIGATION PIPE LINES SHALL BE AS FOLLOWS:

3.13.3.3. PRESSURE SUPPLY LINE:
2-1/2" I.D. PIPE AND SMALLER 18" MIN.
3" AND LARGER 24" MIN.

3.13.3.4. NON-PRESSURE LINE:
2-1/2" I.D. PIPE AND SMALLER 12" MIN.
3" AND LARGER 18" MIN.

3.13.3.5. PRESSURE SUPPLY LINE IN SLEEVE:
UNDER VEHICULAR PAVING 36" MIN.
UNDER PEDESTRIAN PAVING, WALLS OR DRAINAGE FEATURES 18" MIN.

3.13.3.6. NON-PRESSURE LINE IN SLEEVE:
UNDER VEHICULAR PAVING 30" MIN
UNDER PEDESTRIAN PAVING, WALLS OR DRAINAGE FEATURES 18" MIN.

3.13.3.7. ELECTRICAL AND COMMUNICATION CABLE IN SLEEVE:
UNDER VEHICULAR PAVING 36" MIN.
UNDER PEDESTRIAN PAVING, WALLS OR DRAINAGE FEATURES 18" MIN.

3.13.3.8. DRIP DISTRIBUTION TUBING: 4" MIN.

3.13.4. SUBSOIL SHALL BE FREE OF ALL ROCKS OVER ONE (1) INCH DIAMETER, DEBRIS, AND LITTER PRIOR TO USE AS BACKFILL.

3.13.5. REPAIR ANY LEAKS AND REPLACE ALL DEFECTIVE PIPE OR FITTINGS UNTIL LINES MEET TEST REQUIREMENTS. DO NOT COVER ANY LINES UNTIL THEY HAVE BEEN CHECKED AND APPROVED FOR TIGHTNESS, QUALITY OF WORKMANSHIP AND MATERIALS.

3.13.6. BACKFILL TRENCHES, AFTER APPROVAL OF PIPING, WITH SUITABLE AND APPROVED MATERIAL. TAMP SOIL AROUND PIPE AND THOROUGHLY COMPACT ALL TRENCH FILLS UNTIL 90% COMPACTION HAS BEEN ACHIEVED.

3.13.7. BACKFILL MATERIAL SHALL BE AN APPROVED SOIL, FREE FROM ROCKS AND CLODS. PROVIDE BACKFILL UNDER, AROUND AND ABOVE TOP OF PIPE FOR PVC PLASTIC PIPE AND BRASS PIPING.

3.14. CONCRETE THRUST BLOCKS AND SUPPORTS:

3.14.1. THRUST BLOCKS AND FOOTINGS SHALL BE FORMED AND PLACED ON NINETY-PERCENT (90%) MINIMUM COMPACTED OR UNDISTURBED SUBGRADE. CONSTRUCT TO SHAPES SPECIFIED AND PARALLEL TO WALKWAYS. TOOL FINISH EXPOSED SURFACE.

3.15. IDENTIFICATION TAPE: PROVIDE AND INSTALL AS DIRECTED BY THE PLANS AND DETAIL DRAWINGS AND AS REQUIRED BY THE MUNICIPALITY AND/OR WATER PURVEYOR.

3.16. VALVE/STATION IDENTIFICATION, IRRIGATION WATER, DO NOT DRINK WARNING TAG SHALL BE INSTALLED AS DIRECTED BY THE PLANS AND DETAIL DRAWINGS.

3.17. SPRINKLER HEADS:

3.17.1. ALL SPRINKLER HEADS SHALL BE INSTALLED AS PER DETAILS SHOWN.

3.17.2. SHRUB HEADS ON RISERS ARE NOT PERMITTED TO BE LOCATED ADJACENT TO PAVING SURFACES, HEADERS, TOP OF RETAINING WALLS, IN FRONT OF PROJECT SIGNAGE OR IN TURF AREAS.

3.17.3. TOP OF POP-UP SPRINKLER HEADS SHALL BE INSTALLED FLUSH WITH ADJACENT PAVING SURFACE.

3.17.4. POP-UP SPRINKLER HEADS SHALL BE INSTALLED APPROXIMATELY FOUR INCHES AWAY FROM ANY PAVING SURFACE. IN SHRUB AREAS, WHERE POP-UP SPRINKLER HEADS ARE LOCATED AT THE HEAD ON A PARKING STALL, POP-UP SPRINKLERS SHALL BE LOCATED EIGHTEEN INCHES FROM BACK OF CURB.

3.17.5. SPRINKLER HEADS SHALL BE LOCATED OR ADJUSTED TO MINIMIZE OR ELIMINATE OVER-SPRAYING ON SIDEWALKS, STREETS, WINDOWS, WALLS AND ALL OTHER NON-DESIGNATED USE AREAS.

3.17.6. SPRINKLER HEADS WITHIN THE SAME CIRCUIT SHALL BE OF THE SAME MANUFACTURER AND SERIES AND HAVE A UNIFORM PRECIPITATION RATE.

3.17.7. SPACING OF SPRINKLER HEADS SHALL NOT EXCEED MAXIMUM DISTANCES AS INDICATED IN THE IRRIGATION LEGEND.

3.17.8. ADJUST NOZZLES ARCS AND PRESSURE COMPENSATING DEVICES TO SUIT ANY PARTICULAR CONDITIONS OF THE AREA. THIS SHALL BE DONE AFTER THE SYSTEM HAS BEEN THOROUGHLY TESTED, IMMEDIATELY AFTER WRITTEN NOTIFICATION BY THE LANDSCAPE ARCHITECT TO DO SO.

3.18. DRIP IRRIGATION EQUIPMENT: See Detail Drawings.

3.18.1. PRIOR TO START OF CONSTRUCTION THE IRRIGATION CONTRACTOR SHALL CONTACT THE LANDSCAPE ARCHITECT AND/OR THE IRRIGATION CONSULTANT FOR A PRE-CONSTRUCTION MEETING. DURING CONSTRUCTION THE CONTRACTOR SHALL SCHEDULE WITH THE LANDSCAPE ARCHITECT AND/OR IRRIGATION CONSULTANT VISITS TO THE SITE TO OBSERVE COMPLIANCE TO THE PLAN INTENTIONS.

3.18.2. THE MULTI-EXIT EMITTERS USED ON THIS PROJECT ARE INTENDED AS A MEANS OF POINT SOURCE IRRIGATION IN SPARSE PLANTINGS OR IN SMALL GARDEN AREAS WHERE OVERSPRAY MAY CAUSE A PROBLEM. INSTALLATION, NUMBER AND SPACING OF EMISSION POINTS SHALL BE AS DETAILED.

3.18.3. ALL TUBING CONNECTIONS SHALL BE MADE WITH BARBED FITTINGS MANUFACTURED SPECIFICALLY FOR THE TUBING USED.

3.18.4. INSTALL LATERAL BLOW-OUT VALVES HORIZONTALLY LEVEL AT THE HYDRAULIC TERMINATION POINT(S) IN EACH SYSTEM WITHIN VALVE BOX AS DETAILED. ALL LOCATIONS SHALL BE APPROVED BY THE OWNER'S OR THE MANUFACTURERS REPRESENTATIVE.

3.18.5. INSTALL FILTER AND BALL VALVE IN VALVE BOX DIRECTLY UPSTREAM OF THE REMOTE CONTROL VALVE/PRESSURE REDUCING VALVE ASSEMBLY AS DETAILED.

3.18.6. REFER TO IRRIGATION CONSTRUCTION DETAILS AND MANUFACTURER'S GUIDELINES FOR ADDITIONAL INFORMATION.

3.19. FLUSHING SYSTEMS:

3.19.1. AFTER PIPING AND RISERS ARE IN PLACE, BUT PRIOR TO THE INSTALLATION OF THE SPRINKLER HEADS, A FULL HEAD OF WATER SHALL BE USED TO FLUSH OUT THE SYSTEM. AFTER SYSTEM IS THOROUGHLY FLUSHED, CAP ALL RISERS.

3.20. TESTING:

3.20.1. NOTIFY LANDSCAPE ARCHITECT IN WRITING WHEN TESTING WILL BE CONDUCTED. CONDUCT TESTS IN PRESENCE OF THE LANDSCAPE ARCHITECT.

3.21. PRESSURE TEST:

3.21.1. NOTIFY LANDSCAPE ARCHITECT IN WRITING WHEN PRESSURE TESTING WILL BE CONDUCTED. CONDUCT TESTS IN PRESENCE OF THE LANDSCAPE ARCHITECT AND/OR OWNER'S REPRESENTATIVE.

3.21.2. ALL PRESSURE LINES SHALL BE TESTED UNDER HYDROSTATIC PRESSURE OF 125 LBS PER SQUARE INCH AND ALL NON PRESSURE LINES SHALL BE TESTED UNDER THE EXISTING STATIC PRESSURE AND BOTH BE PROVEN WATERTIGHT. (CONTRACTOR TO SUPPLY ALL HYDROSTATIC TEST EQUIPMENT NEEDED FOR TESTING.)

3.21.3. PRESSURE SHALL BE SUSTAINED IN THE LINES FOR NOT LESS THAN FOUR HOURS. IF LEAKS DEVELOP, THE JOINTS SHALL BE REPLACED AND THE TEST REPEATED UNTIL THE ENTIRE SYSTEM IS PROVEN WATERTIGHT.

3.21.4. TESTS SHALL BE OBSERVED AND APPROVED BY THE CITIES AND WATER DISTRICT'S INSPECTOR, LANDSCAPE ARCHITECT AND/OR OWNER PRIOR TO BACKFILL. BACKFILLING TRENCHES PRIOR TO INSPECTION WILL NOT BE ALLOWED AND ALL PREMATURELY FILLED TRENCHES SHALL BE SUBJECT TO REOPENING AS DIRECTED BY THE LANDSCAPE ARCHITECT.

3.22. COVERAGE TEST:

3.22.1. NOTIFY LANDSCAPE ARCHITECT IN WRITING WHEN COVERAGE TESTING WILL BE CONDUCTED. CONDUCT TESTS IN PRESENCE OF THE LANDSCAPE ARCHITECT AND OWNER'S REPRESENTATIVE.

3.22.2. COVERAGE TESTING: PERFORM OPERATIONAL TESTING AFTER HYDROSTATIC TESTING IS COMPLETED, BACKFILL IS IN PLACE, AND SPRINKLER HEADS ADJUSTED TO FINAL POSITION.

3.22.3. AFTER COMPLETION OF LANDSCAPE WORK, CAREFULLY ADJUST HEADS SO THEY WILL BE FLUSH WITH LAWN AREAS OR NOT MORE THAN 1/2" ABOVE FINISH GRADE IN GROUNDCOVER AREA.

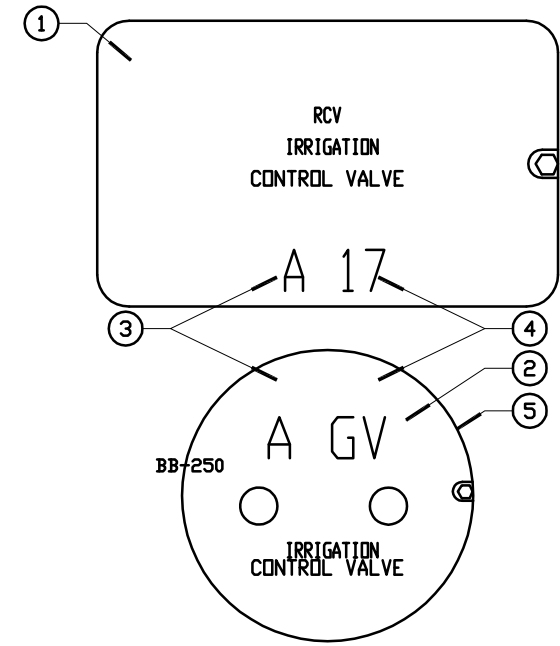

1. VALVE BOX WITH LOCKABLE COVER.
2. 2" BRANDING, PER THE IRRIGATION SPECIFICATIONS.
3. CONTROLLER DESIGNATION.
4. VALVE IDENTIFICATION.
5. ROUND VALVE BOX WITH LOCKABLE COVER.

L VALVE BOX HEAT BRANDING NTS

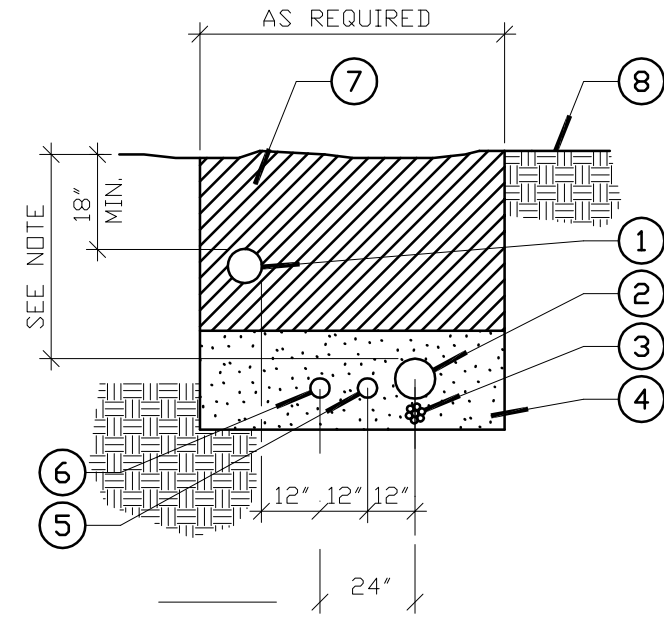

1. NON-PRESSURE LATERAL LINE .
2. PRESSURIZED MAINLINE.
3. CONTROL WIRES - BUNDLE AND TAPE EVERY TEN FEET. INSTALL ADJACENT TO PRESSURE MAIN LINE.
4. APPROVED TOP SOIL OR SAND BACKFILL - PROVIDE 3" UNDER PIPE AND 6" ABOVE PIPE.
5. FLOW SENSOR CABLE AND CONDUIT.
6. COMMUNICATION CABLE CONDUIT (WHERE REQUIRED).
7. SEE IRRIGATION SPECS FOR BACKFILL AND COMPACTION REQUIREMENTS.
8. FINISH GRADE.

NOTE:
 A. MINIMUM BACKFILL DEPTHS FROM GRADE TO TOP OF MAINLINE 24" IN PLANTING AREAS, 36" UNDER PAVED AREAS.
 B. ALL PLASTIC PIPING TO BE SNAKED IN TRENCHES.
 C. TIE LOOSE 20" LOOP IN WIRING AT CHANGE IN DIRECTION GREATER THAN 30°. TIE ALL LOOPS AFTER ALL CONNECTIONS HAVE BEEN MADE.

P Trenching Detail Within The Landscape NTS

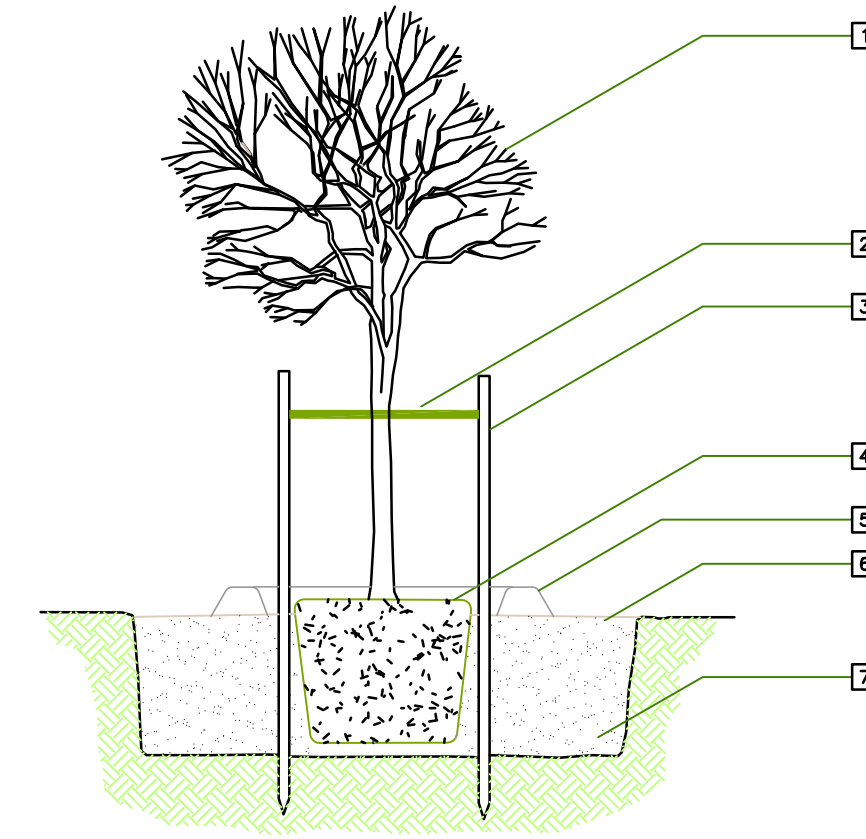

- 1 PRUNE TREE AT TIME OF STAKE REMOVAL PER LANDSCAPE ARCHITECT'S DIRECTION
- 2 TREE TIE, 1" (MIN.) IN WIDTH
- 3 (2) 2" DIA. X10' LONG LODGEPOLE PINE TREE STAKES. BURY 3' IN GROUND AND CUT OFF STAKE 12" ABOVE TREE TIE. STAKES SHALL REMAIN IN PLACE FOR 2 YEARS UNLESS REMOVAL IS APPROVED BY LANDSCAPE ARCHITECT.
- 4 SET TOP OF ROOTBALL AT SOIL SURFACE
- 5 FORM TEMPORARY IRRIGATION BORDER JUST OUTSIDE OF ROOTBALL. USE WATER TO SETTLE BACKFILL
- 6 MULCH TO DEPTH OF 1/2", 5' IN DIAMETER. KEEP MULCH 6" AWAY FROM TRUNK.
- 7 BACKFILL WITH NATIVE SOIL (NO ROCKS GREATER THAN 1") APPLY FERTILIZER TO SURFACE AWAY FROM TRUNK PER SPECS. PLANTING HOLE SHALL BE 3 TIMES DIAMETER OF ROOTBALL AND NO DEEPER. SCARIFY SIDES AND BOTTOM OF PLANTING HOLE

NOTE:
 SUFFICIENT CLEARANCE SHALL BE MAINTAINED BETWEEN TREES AND UTILITY FACILITIES SO AS NOT TO HINDER USE OF THESE FACILITIES. SCARIFY ONE SIDE OF ROOTBALL PRIOR TO PLANTING.

G TREE PLANTING NTS

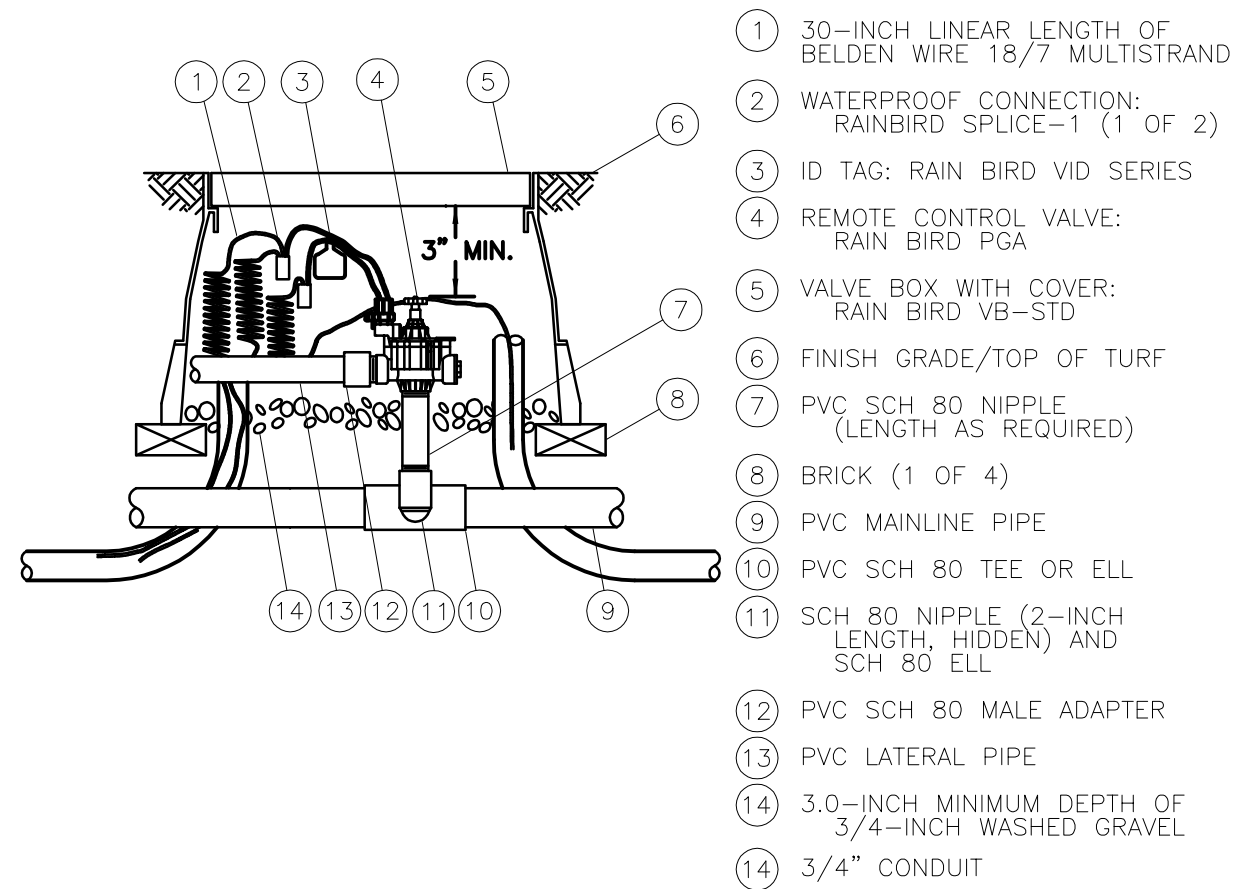

- 1 30-INCH LINEAR LENGTH OF BELDEN WIRE 18/7 MULTISTRAND
- 2 WATERPROOF CONNECTION: RAINBIRD SPLICE-1 (1 OF 2)
- 3 ID TAG: RAIN BIRD VID SERIES
- 4 REMOTE CONTROL VALVE: RAIN BIRD PGA
- 5 VALVE BOX WITH COVER: RAIN BIRD VB-STD
- 6 FINISH GRADE/TOP OF TURF
- 7 PVC SCH 80 NIPPLE (LENGTH AS REQUIRED)
- 8 BRICK (1 OF 4)
- 9 PVC MAINLINE PIPE
- 10 PVC SCH 80 TEE OR ELL
- 11 SCH 80 NIPPLE (2-INCH LENGTH, HIDDEN) AND SCH 80 ELL
- 12 PVC SCH 80 MALE ADAPTER
- 13 PVC LATERAL PIPE
- 14 3/4-INCH MINIMUM DEPTH OF 3/4-INCH WASHED GRAVEL
- 14 3/4" CONDUIT

D ELECTRIC REMOTE CONTROL VALVE 1-23-04 REVISED
 NTS PGA-BI-PRSD-2000

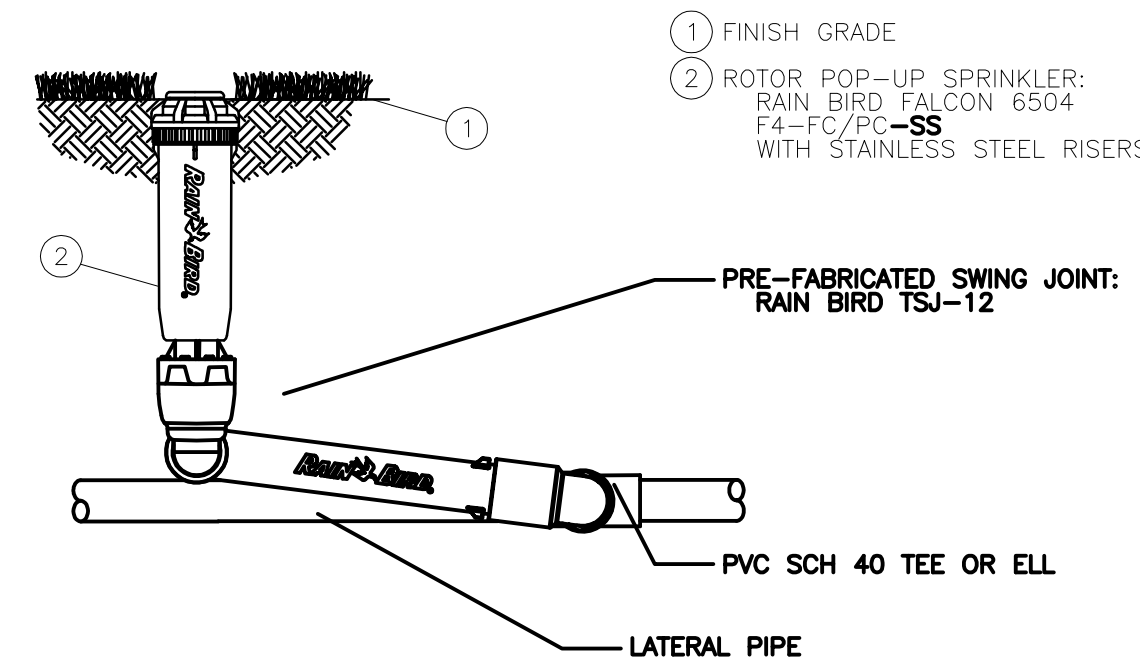

D ROTOR POP UP SPRINKLER 4-27-04
 NTS FALCON-6504

INSTALL BREATHER TUBES ON ALL TREES PER THE FOLLOWING SCHEDULE:

15 GALLON	(1) - 3"
24" BOX	(2) - 3"
36" BOX	(3) - 3"
48" BOX	(4) - 4"
60" BOX & LARGER	(4) - 4"
B&B PALMS	

DO NOT INSTALL TUBES FOR PLANT MATERIAL INSTALLED ON SLOPES

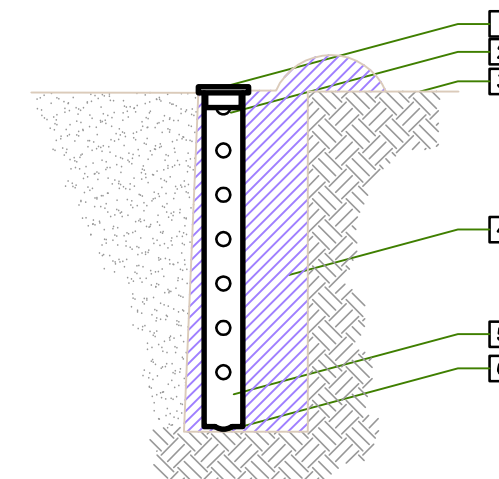

- 1 NDS SLOTTED GRATE (PER PIPE SIZE) GRATE TO SLIDE INTO PIPE SECURE WITH STAINLESS STEEL SELF TAPPING SCREWS
- 2 RIGID PERFORATED S&D PIPE SEE SCHEDULE ABOVE FOR SIZE AND NUMBER PER PLANT.
- 3 DUCT TAPE OVER HOLES WITHIN 6" OF FINISHED GRADE.
- 4 FINISHED GRADE
- 5 BACKFILL MIX PER SPECIFICATIONS
- 6 BREATHER TUBE TO EXTEND TO FULL DEPTH OF PLANTING HOLE
- 7 FILL PIPE WITH CLEAR 1" STONE

M BREATHER TUBE NTS

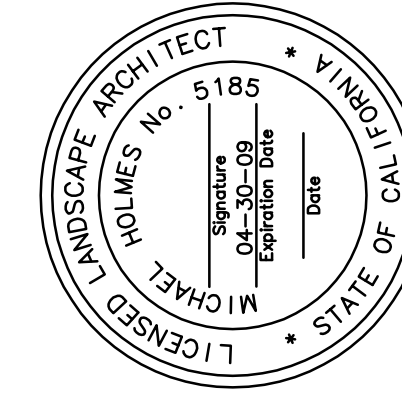

PINNACLE Civil Engineering, Inc.
 2161 Saturn Court, Bakersfield, CA 93308
 Phone: (661) 869-0184 Fax: (661) 377-0076

MICHAEL HOLMES	LA 5185 EXP. 4/30/09	DATE
REVISIONS	DELETED NORTH PORTION OF SITE	7-14-09
	SPECIFIED TREES AND IRRIGATION COMPONENTS	

LANDSCAPE & IRRIGATION DETAILS
 BCSD - WAYSIDE ELEMENTARY
 PLANTING DETAILS
 BAKERSFIELD, CALIFORNIA

CALL: 1-800-227-2600

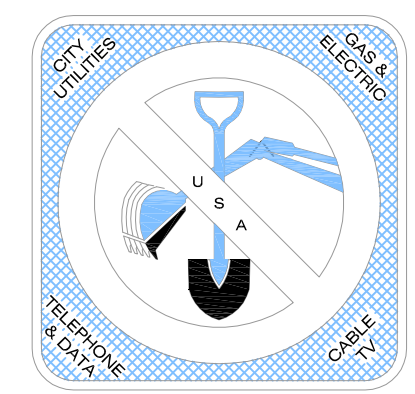

JOB No.:	07-320
DWG NO.:	07-320GRBM
DATE:	04/07/08
DRAWN BY:	MH
CHECKED BY:	MH
SHEET	6
	OF 7 SHEETS

IRRIGATION PLAN

PLANTING PLAN

BUILDING 'A'
DSA 5633 DSA 53548

BUILDING 'A'
DSA 5633 DSA 53548

BUILDING 'B'
DSA 5633 DSA 53548

BUILDING 'B'
DSA 5633 DSA 53548

BUILDING 'C'
DSA 5633 DSA 53548

BUILDING 'C'
DSA 5633 DSA 53548

PROPOSED ASPHALT

FESCUE SOD

CONTRACTOR TO HAUL AND SPREAD BCSD'S TOPSOIL.
CONTRACTOR IS RESPONSIBLE FOR ESTABLISHING FINISH GRADE
CONTRACTOR TO AMEND SOIL PER SPECIFICATIONS

BCSD HAS PRIVATE UTILITIES THIS AREA CONTACT BEFORE DIGGING

LIMIT OF WORK
CONTRACTOR TO CUT A CLEAN EDGE IN EXISTING
SOD TO INTERFACE WITH EXISTING SOD

CONTRACTOR TO REMOVE TWO
EXISTING SHRUBS AND SOD AREA

LEGEND

- RAINBIRD 6504 FALCON WITH STAINLESS STEEL RISERS
NUMBER INDICATES NOZZLE TO BE USED
- ◁ RAINBIRD 2" PGA REMOTE CONTROL VALVE
ALL CONTROL WIRES TO BE INSTALLED IN 3/4" GREY CONDUIT
- MAIN LINE TO BE 2" SCHEDULE 40 WITH SCHEDULE 80 FITTINGS
ALL LATERAL LINES TO BE 2" SCHEDULE 40
ALL CHANGES IN DIRECTION GREATER THAN 45 DEGREES
TO HAVE THRUST BLOCKS
VALVE MAINFOLD TO BE SCHEDULE 80 FITTINGS AND PIPE
PER BCSD SYSTEM PRESSURE IS 60-70 PSI AT HEAD
IF PRESSURE IS NOT AT LEAST 60 PSI
CONTACT LANDSCAPE ARCHITECT

ACCEPTABLE ALTERATES

HUNTER I-25 HEADS-MATCH NOZZLES FOR PRECIP RATE
HUNTER ICV CONTROL VALVES

LEGEND

- ▨ PROPOSED TURF FESCUE SOD
- 24" BOX QUERCUS AGRIFOLIA

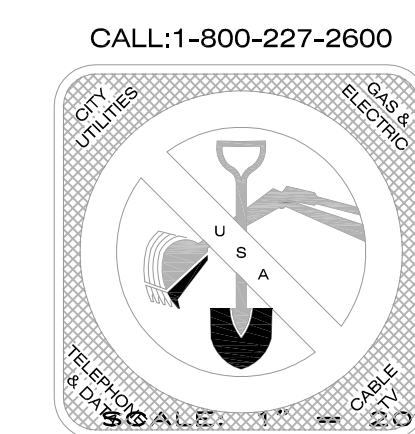
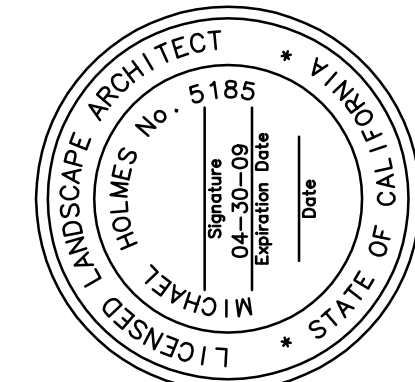

Pinnacle Civil Engineering, Inc.
2161 Saturn Court, Bakersfield, CA 93308
Phone: (661) 869-0184 Fax: (661) 377-0076

MICHAEL HOLMES	LA 5185 EXP. 4/30/09
REVISIONS	DATE
DELETED NORTH PORTION OF SITE	7-14-09
SPECIFIED TREES AND IRRIGATION COMPONENTS	

LANDSCAPE & IRRIGATION PLANS
BCSD - WA YSIDE ELEMENTARY
IRRIGATION PLAN
BAKERSFIELD, CALIFORNIA

JOB No.:	07-320
DWG NO.:	07-320GRBM
DATE:	04/07/08
DRAWN BY:	MH
CHECKED BY:	MH
SHEET	7
OF 7 SHEETS	

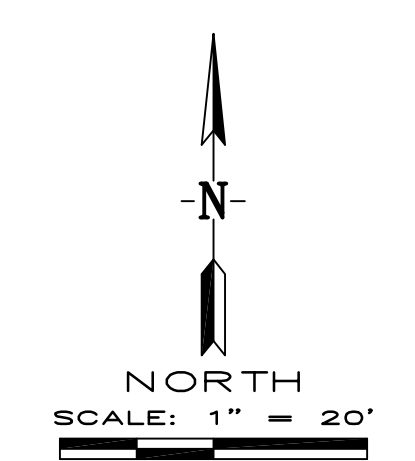
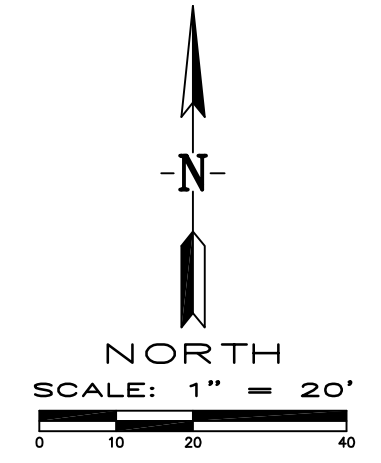
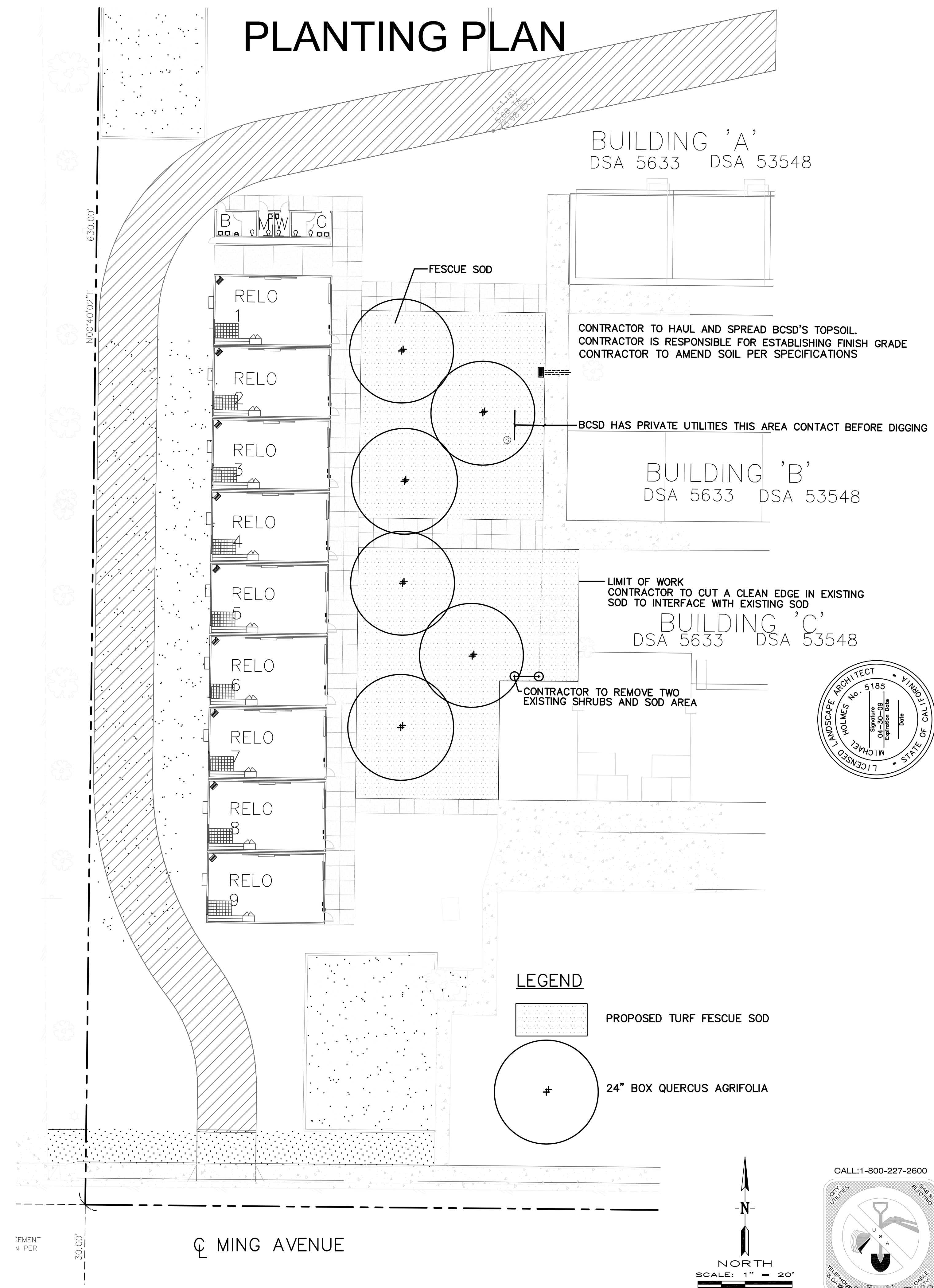
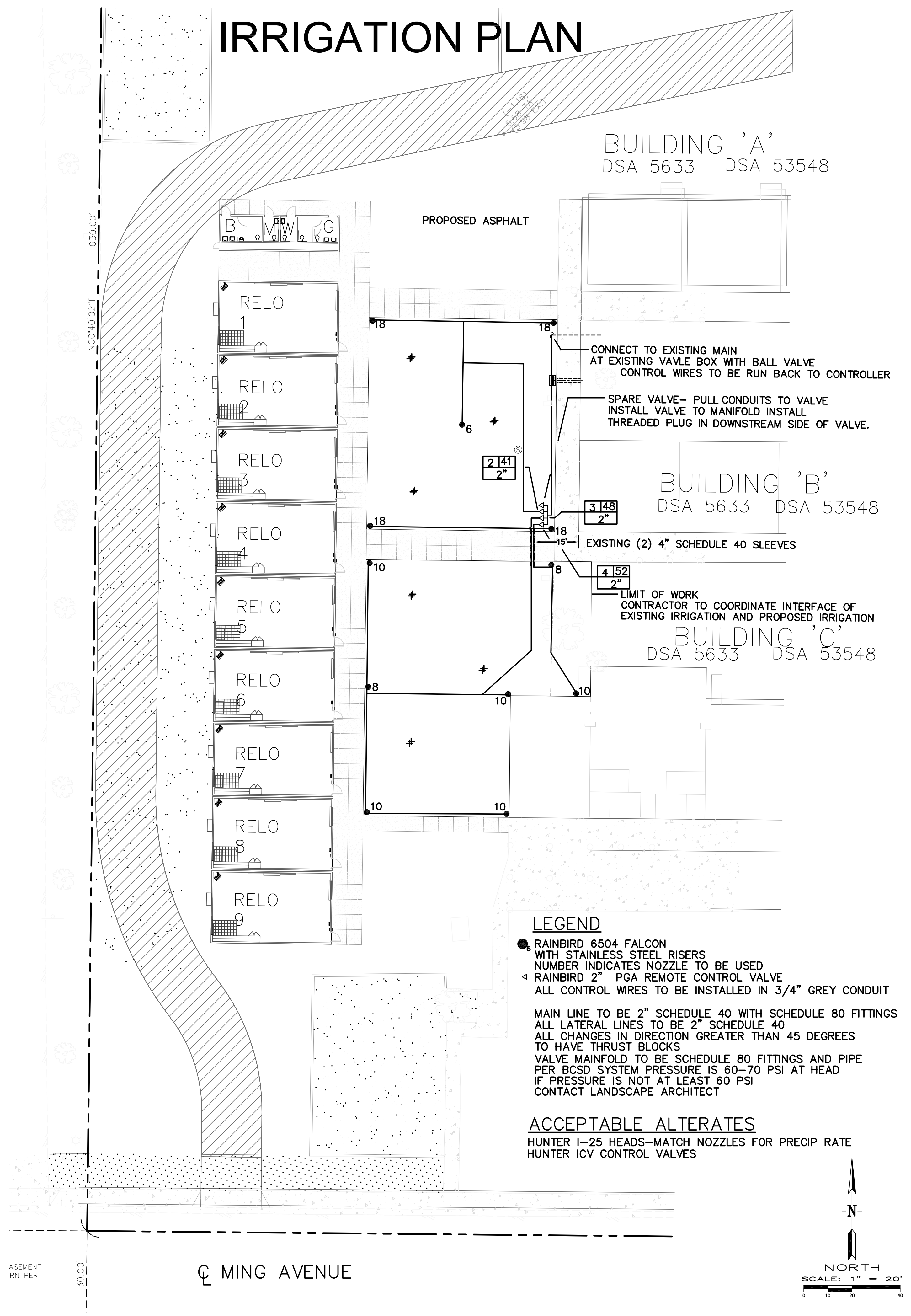

30.00' MING AVENUE

30.00' MING AVENUE