

TUBULAR SKYLIGHT SECTION SCALE: 1" = 1'-0" 16

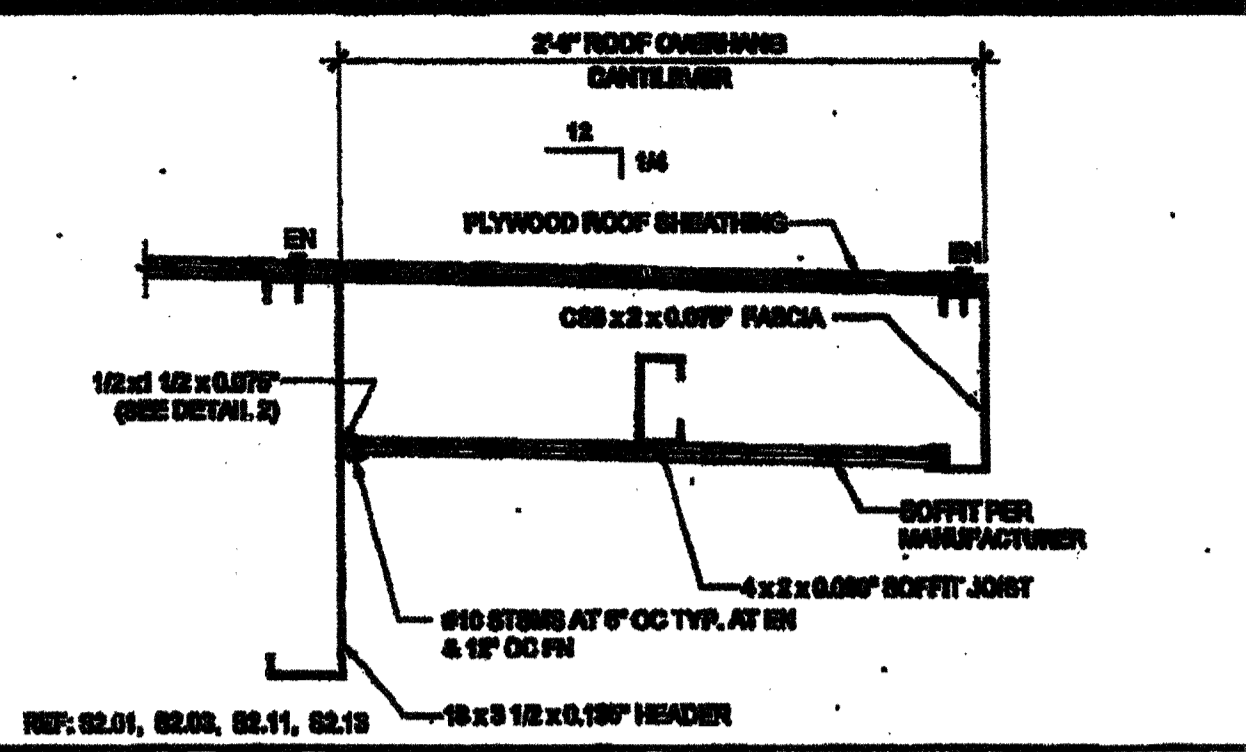

REAR OVERHANG SECTION SCALE: 1 1/2" = 1'-0" 11

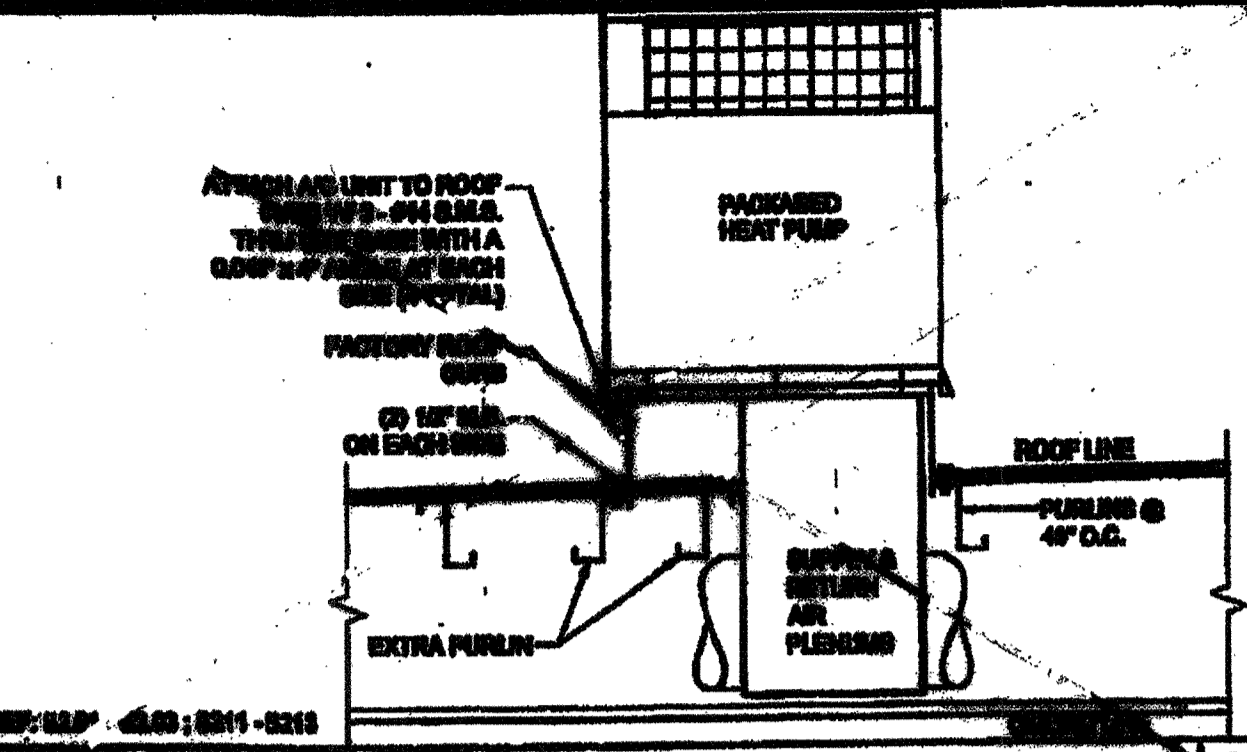

HVAC CURB ATTACHMENT SCALE: 3/4" = 1'-0" 8

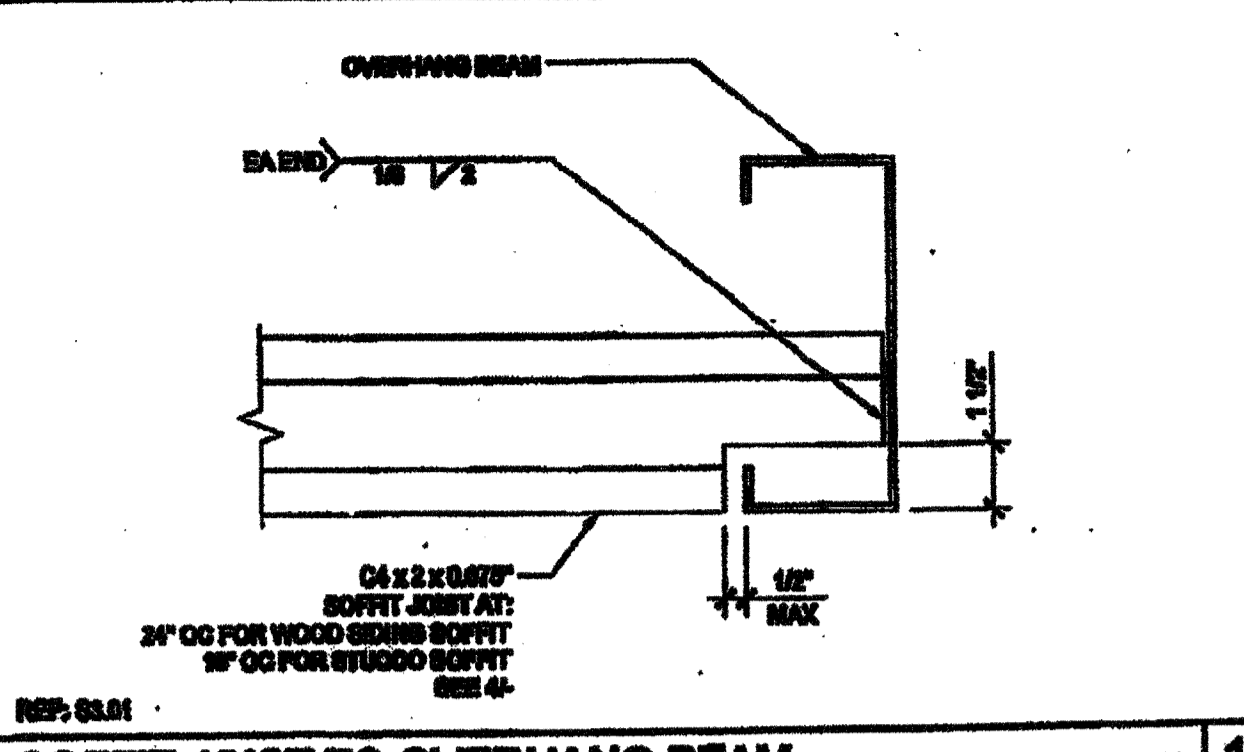

SOFFIT JOIST TO OVERHANG BEAM SCALE: 3/4" = 1'-0" 1

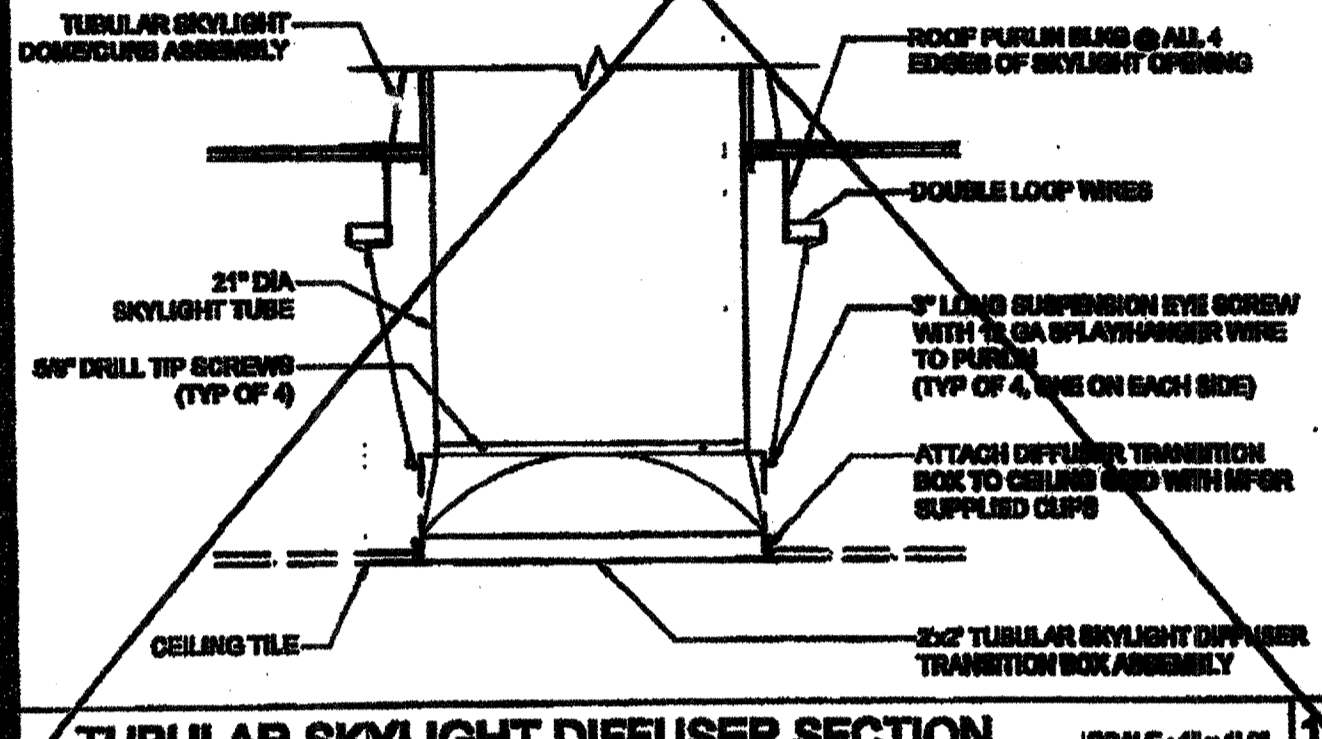

TUBULAR SKYLIGHT DIFFUSER SECTION SCALE: 1" = 1'-0" 17

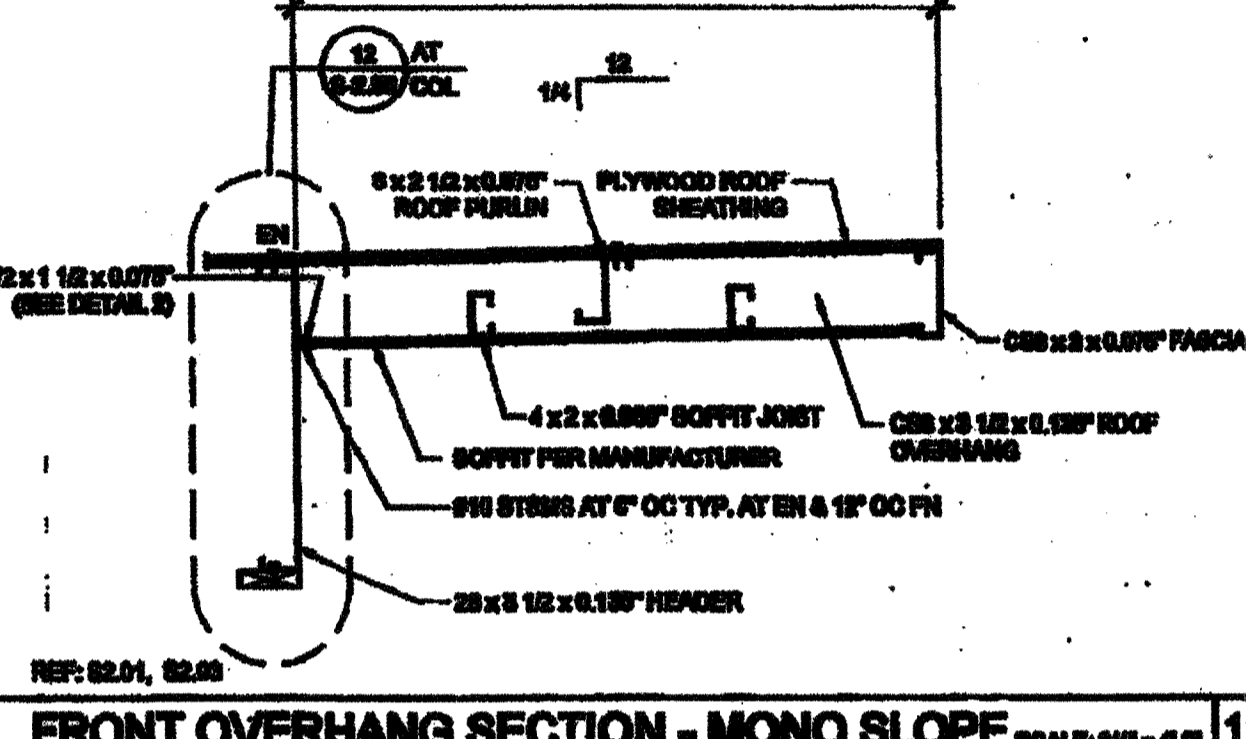

FRONT OVERHANG SECTION - MONO SLOPE SCALE: 3/4" = 1'-0" 12

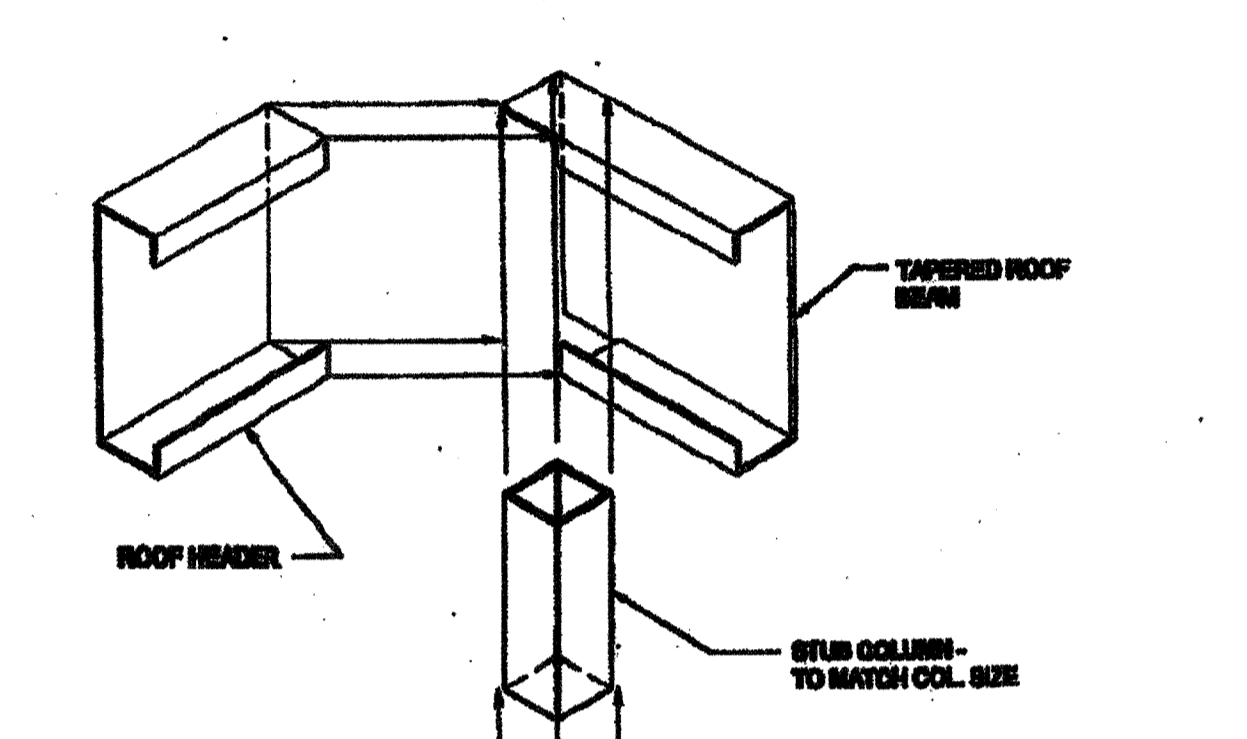

COLUMN CONNECTION AT ROOF SCALE: 1/8" = 1'-0" 8

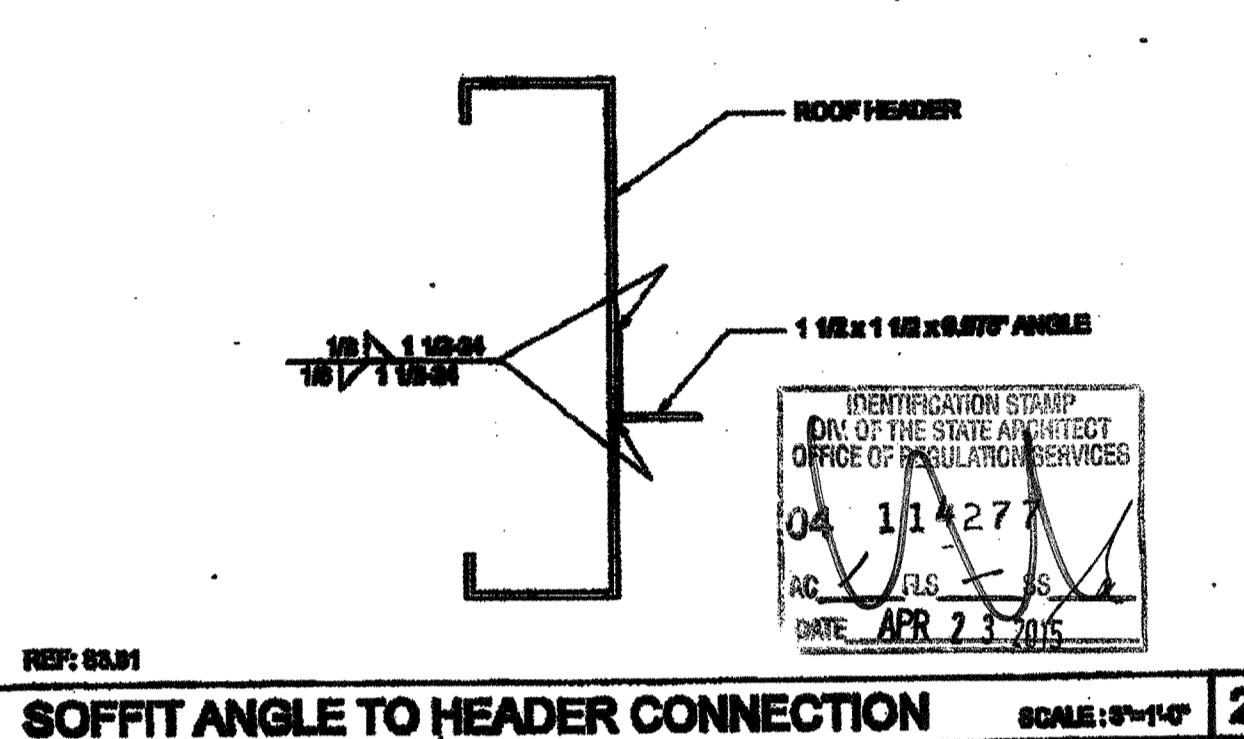

SOFFIT ANGLE TO HEADER CONNECTION SCALE: 3/4" = 1'-0" 2

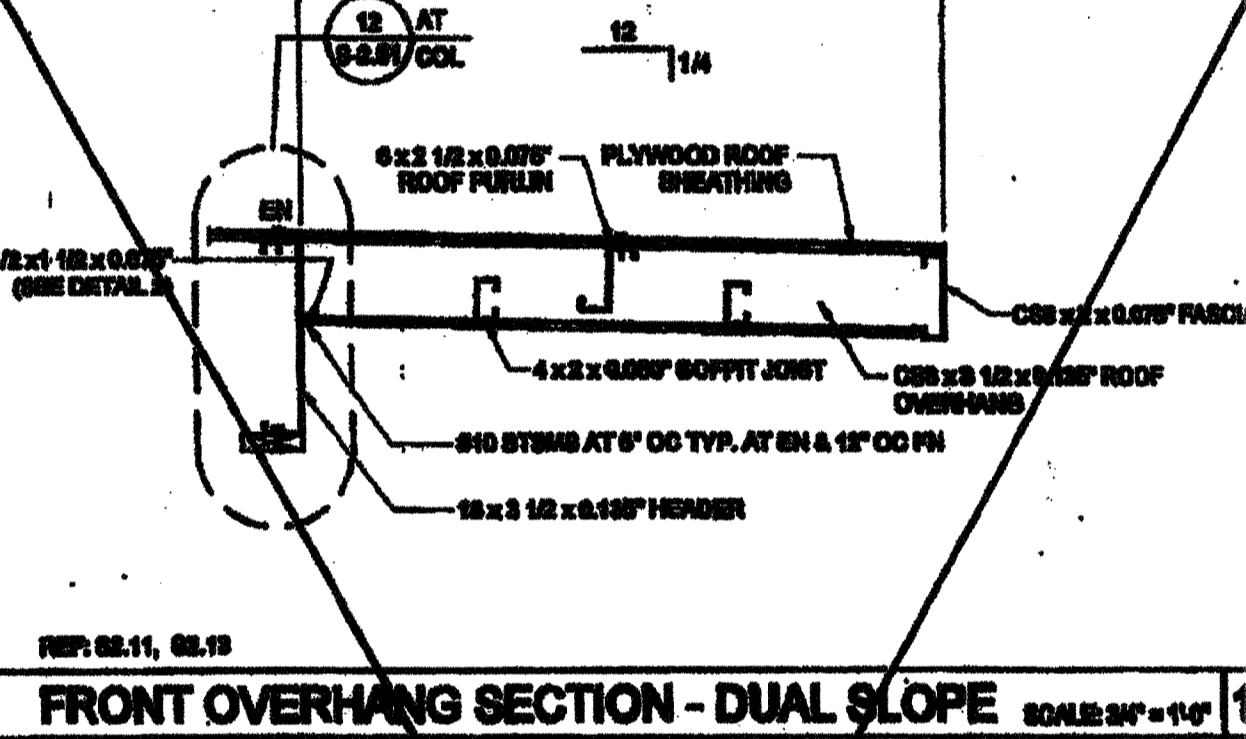
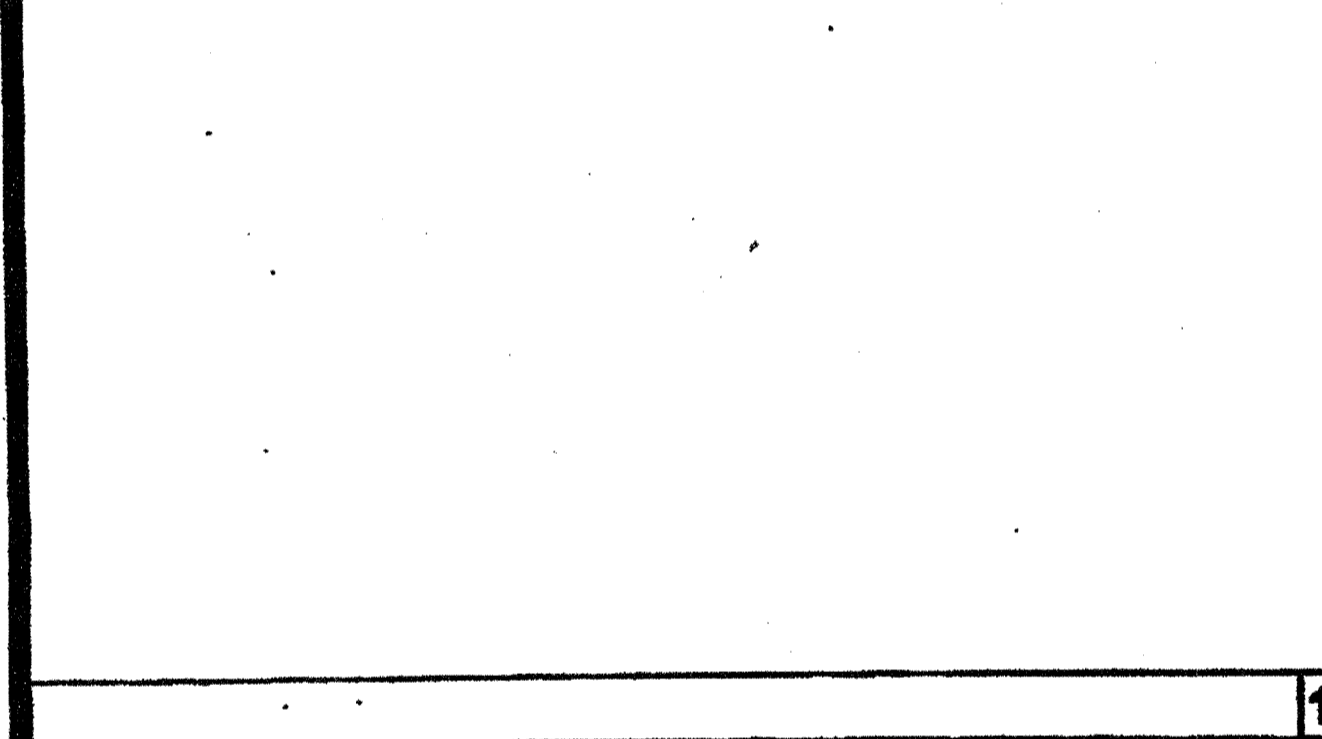

FRONT OVERHANG SECTION - DUAL SLOPE SCALE: 3/4" = 1'-0" 13

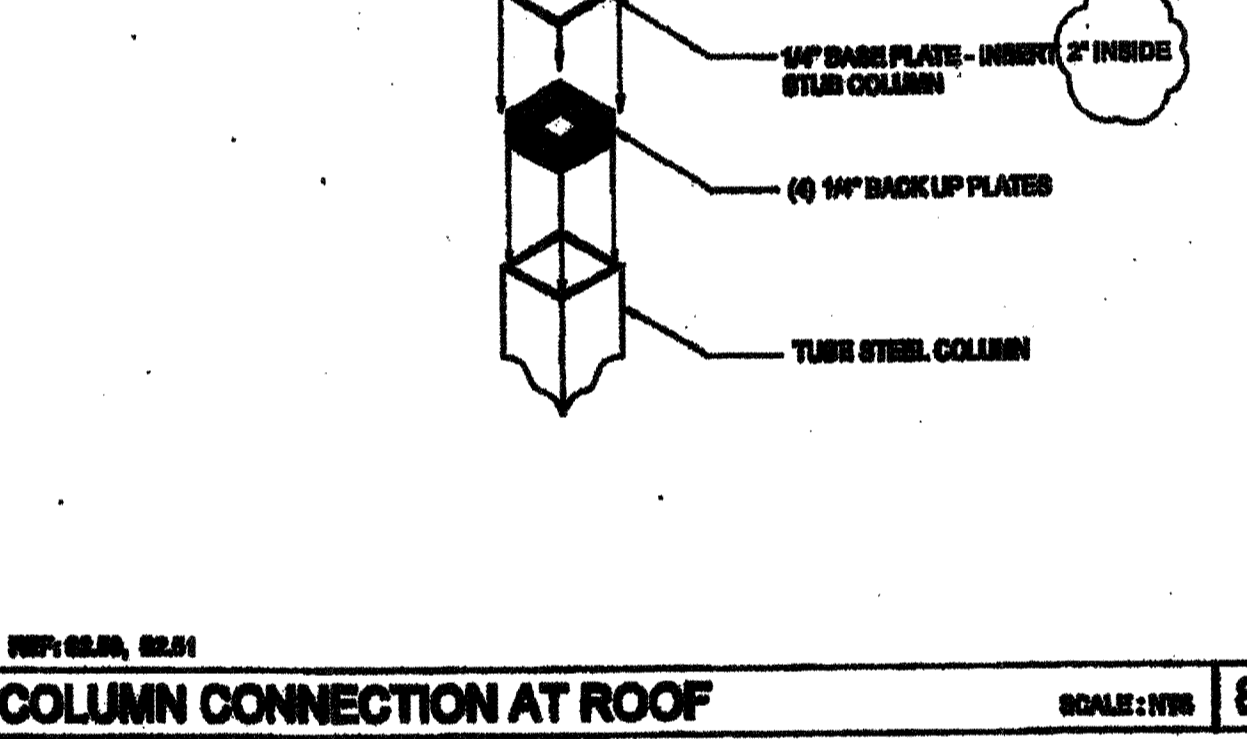

DOUBLE PURLINS AT HVAC SCALE: 1 1/2" = 1'-0" 9

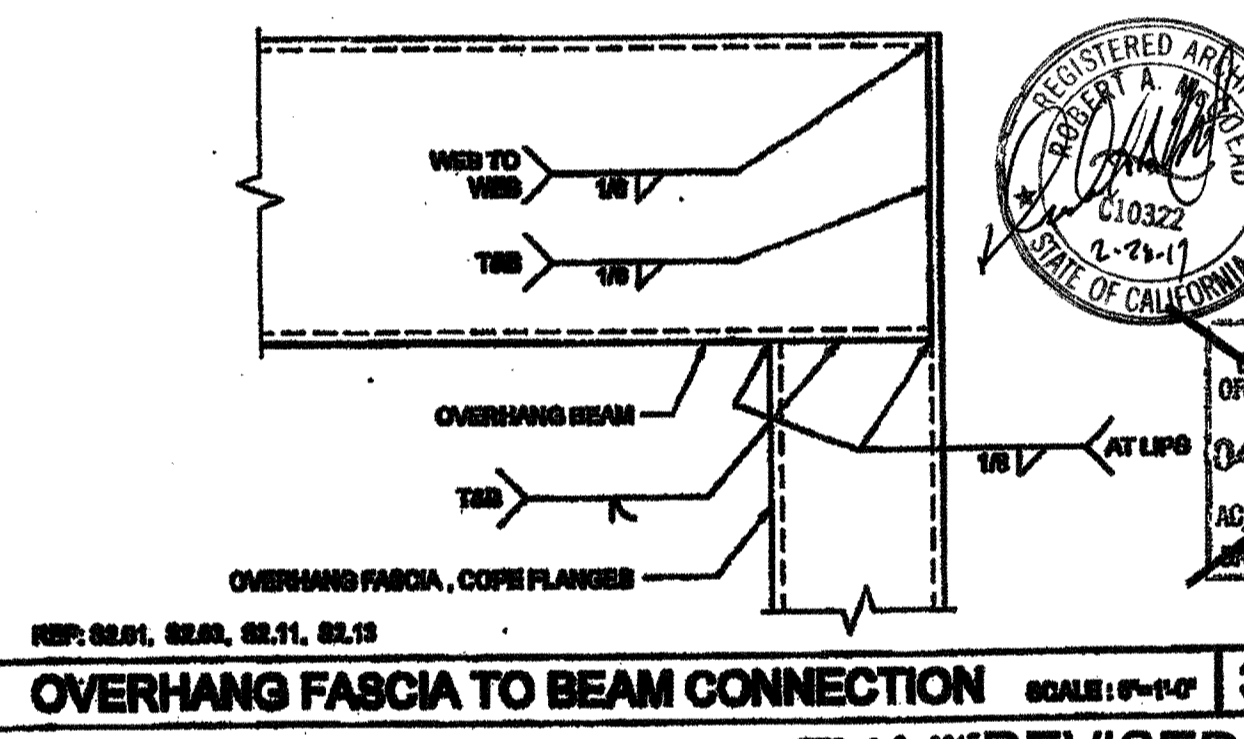

OVERHANG FASCIA TO BEAM CONNECTION SCALE: 3/4" = 1'-0" 3

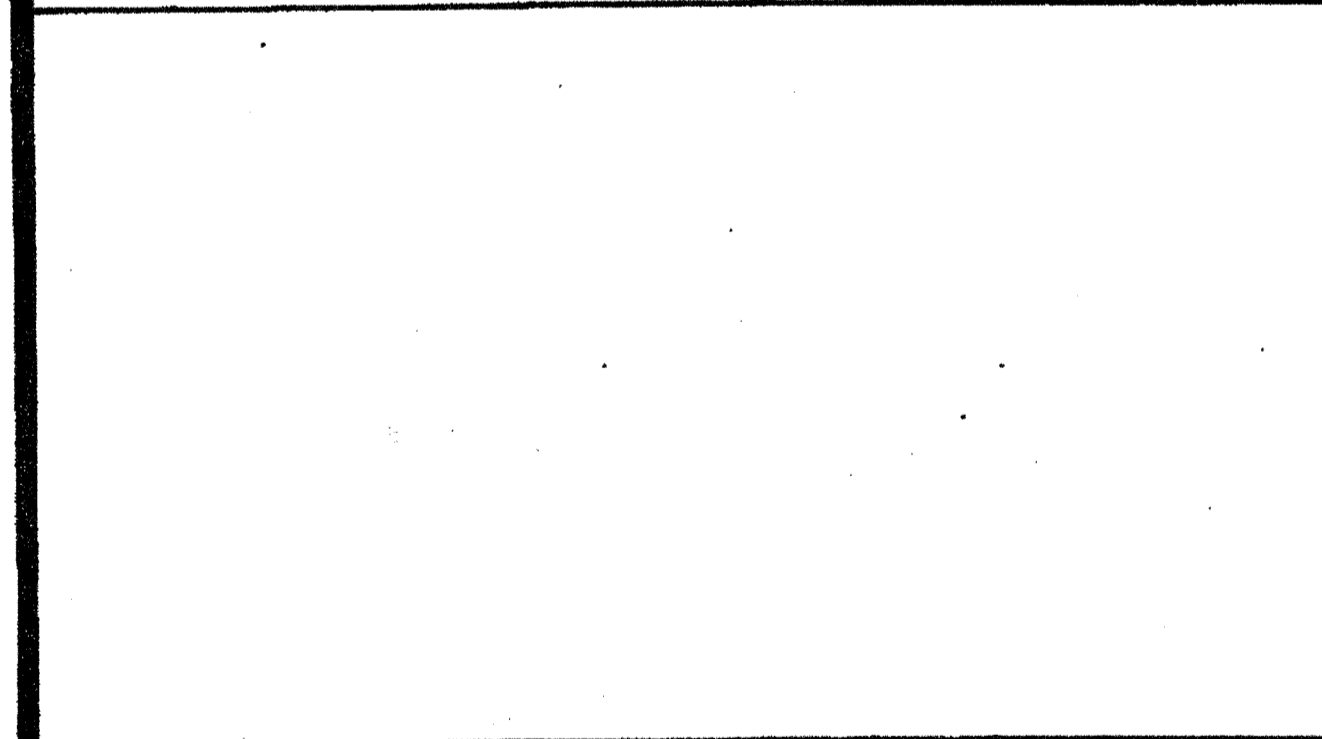

5'-0" ROOF OVERHANG AT 0.030" ROOF SCALE: 3/4" = 1'-0" 19

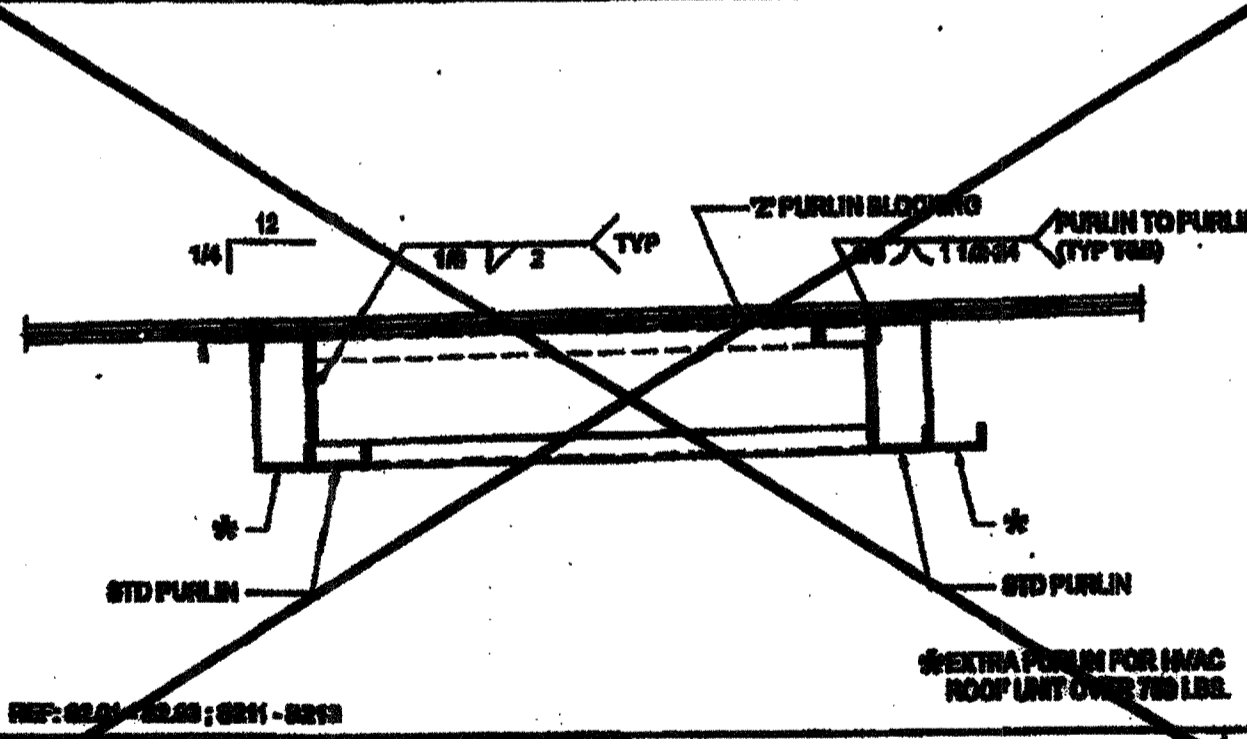

SOFFIT JOIST SCALE: 3/4" = 1'-0" 4

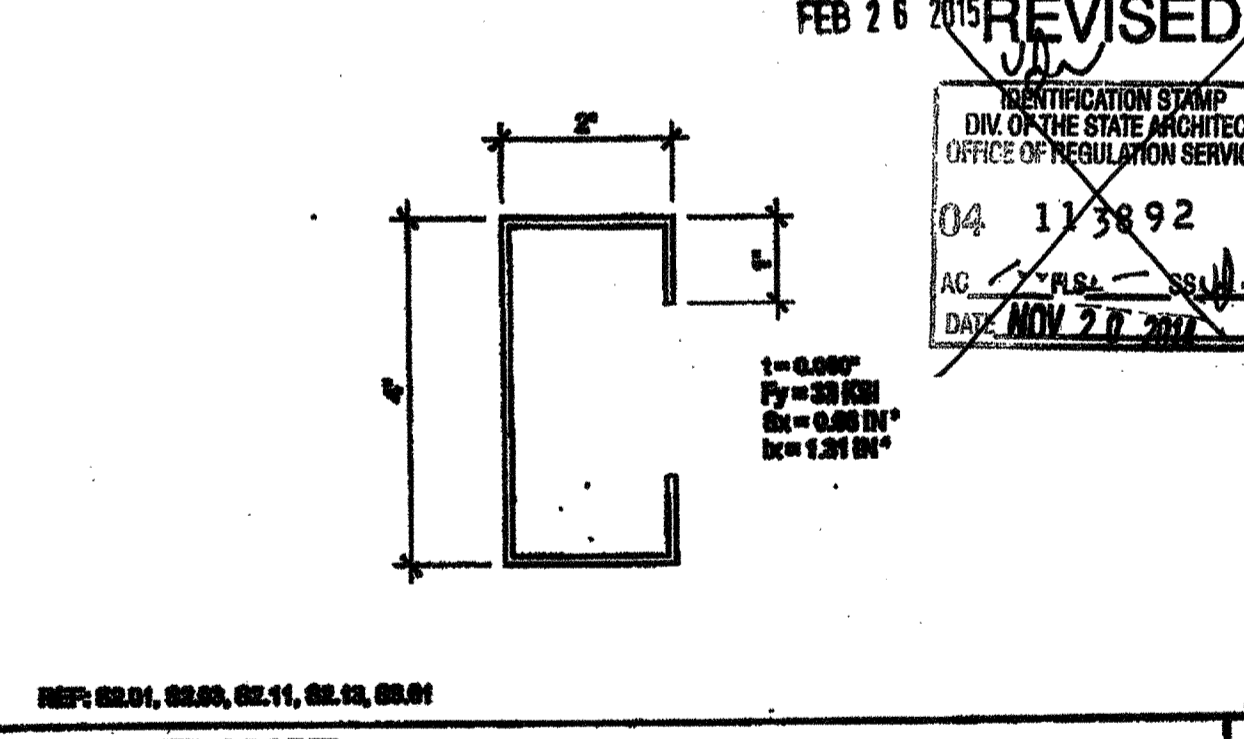

OVERHANG SUPPORT TO ROOF HDR @ STIFFENER SCALE: 3/4" = 1'-0" 10

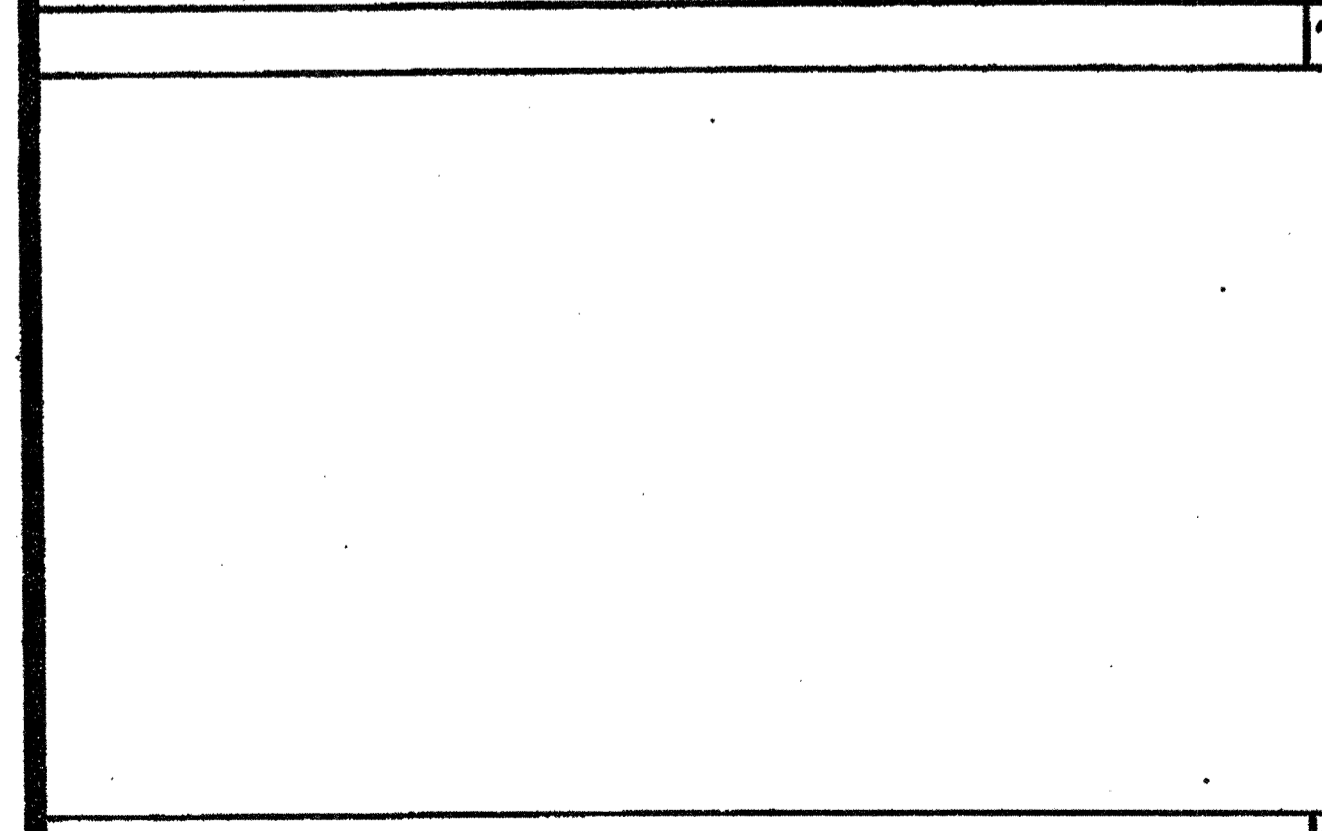

5'-0" ROOF OVERHANG AT 0.030" ROOF SCALE: 3/4" = 1'-0" 20

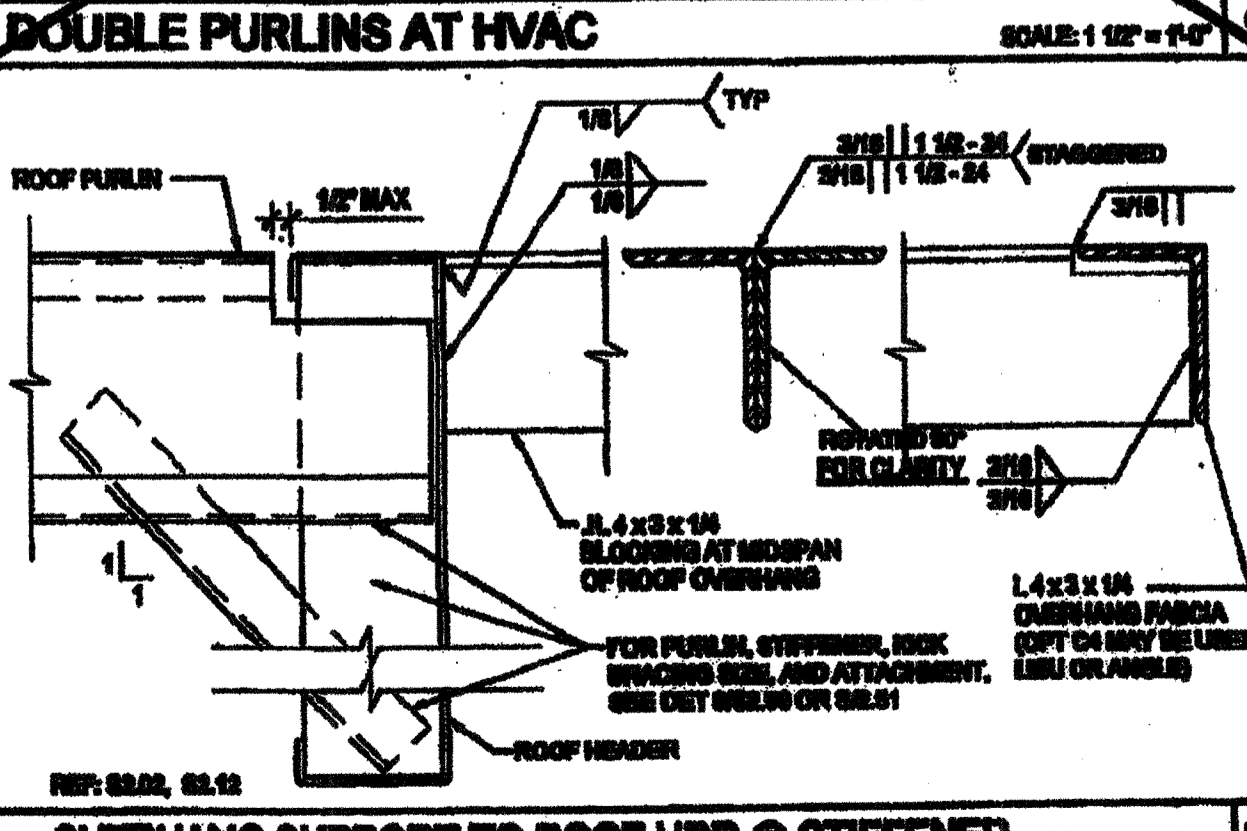

OVERHANG FASCIA & BEAM SCALE: 3/4" = 1'-0" 5

THESE DRAWINGS AND ALL MATERIAL COVERED HEREIN ARE THE PROPERTY OF SILVER CREEK INDUSTRIES, INC. (SCI) AND SHALL NOT BE REPRODUCED, COPIED OR OTHERWISE EMPLOYED IN WHOLE OR IN PART TO ASSIST IN THE DESIGN OR CONSTRUCTION OF ANY BUILDING OR STRUCTURE FOR THE PURPOSE OF FURNISHING ANY INFORMATION FOR THE DESIGN OF BUILDINGS, PARTS, APPLIANCES OR PARTS THEREOF WITHOUT THE FULL INKED-AND-WRITTEN CONSENT OF SCI. ALL FURNISHED MATERIALS CONTAINED HEREIN AND COVERINGS WITH SCI SHALL BE ON THE PROPERTY OF SCI.

SILVER CREEK INDUSTRIES, INC.
BUILDING FOR THE WESTERN MARKET
SILVER CREEK

175 EAST MICHIGAN FREEWAY, CALIFORNIA 92571
PHONE: 951-920-8888 FAX: 951-943-2217

PROJECT NAME: CLASS LEASING CLASSROOM BLDG'S

SHEET TITLE: ROOF FRAMING DETAILS

JAVARE
REGISTERED ARCHITECT
STATE OF CALIFORNIA
SEP 19 2012

IDENTIFICATION STAMP
DIV. OF THE STATE ARCHITECT
OFFICE OF REGULATION SERVICES
04 11 277
AC: FLS
DATE: APR 23 2015

REGISTERED ARCHITECT
STATE OF CALIFORNIA
AUG 28 2014

REGISTERED ARCHITECT
STATE OF CALIFORNIA
AUG 28 2014

PROJECT APPROVED BY STATE AGENCY APPROVAL
REGISTERED ARCHITECT
DIV. OF THE STATE ARCHITECT
OFFICE OF REGULATION SERVICES
04 11 277
AC: FLS
DATE: APR 23 2015

REGISTERED ARCHITECT
STATE OF CALIFORNIA
AUG 28 2014

REGISTERED ARCHITECT
STATE OF CALIFORNIA
AUG 28 2014

REVISIONS

PC REVISION 03/14/2012

SILVER CREEK INDUSTRIES
34' x 40' FC

PROJECT NO:
DRAWN BY:
SCALE: AS NOTED
DATE: 12-22-11
P.C. SHEET NUMBER

S-2.60 STKP 140