

THESE DRAWINGS AND ALL MATERIAL CONTAINED HEREIN ARE THE PROPERTY OF SILVERCREEK INDUSTRIES, INC. (SCI) AND SHALL NOT BE REPRODUCED, COPIED OR OTHERWISE USED IN WHOLE OR IN PART TO ASSIST IN THE MAKING OF OR FOR THE PURPOSE OF FURNISHING ANY INFORMATION FOR THE MAKING OF DRAWINGS, PRINTS, APPARATUS OR PARTS THEREOF WITHOUT THE FULL KNOWLEDGE AND WRITTEN CONSENT OF SCI. ALL PATENTABLE MATERIAL CONTAINED HEREIN AND ORIGINATING WITH SCI SHALL BE THE PROPERTY OF SCI.

SILVER CREEK INDUSTRIES, INC.
 BUILDING FOR THE NEXT GENERATION
SILVER CREEK
 195 EAST MORGAN PERRIS, CALIFORNIA 92571
 PHONE: 951-943-9293 FAX: 951-943-2211

PROJECT NAME:
CLASS LEASING CLASSROOM BLDG'S

SHEET TITLE:
ROOF FRAMING DETAILS MONO SLOPE

STAVRES ARCHITECTURE
 REGISTERED ARCHITECT
 12/28/2011
 ARCHITECT OF RECORD
 DIVISION OF THE STATE ARCHITECT
 OFFICE OF REGULATION SERVICES
 04 113892
 DATE: APR 27 2015

PROJECT SPECIFIC STATE AGENCY APPROVAL
 IDENTIFICATION STAMP
 DIV. OF THE STATE ARCHITECT
 OFFICE OF REGULATION SERVICES
 04 113892
 DATE: APR 27 2015

ORIGINAL PD STATE AGENCY APPROVAL
 IDENTIFICATION STAMP
 DIV. OF THE STATE ARCHITECT
 OFFICE OF REGULATION SERVICES
 PC 04-112072
 DATE: DEC 3 2011

REVISIONS

SILVER CREEK INDUSTRIES
 24' x 40' PC
 PROJECT NO:
 DRAWN BY:
 SCALE: AS NOTED
 DATE: 12-23-11
 P.C. SHEET NUMBER
S-2.50
 STKP 140

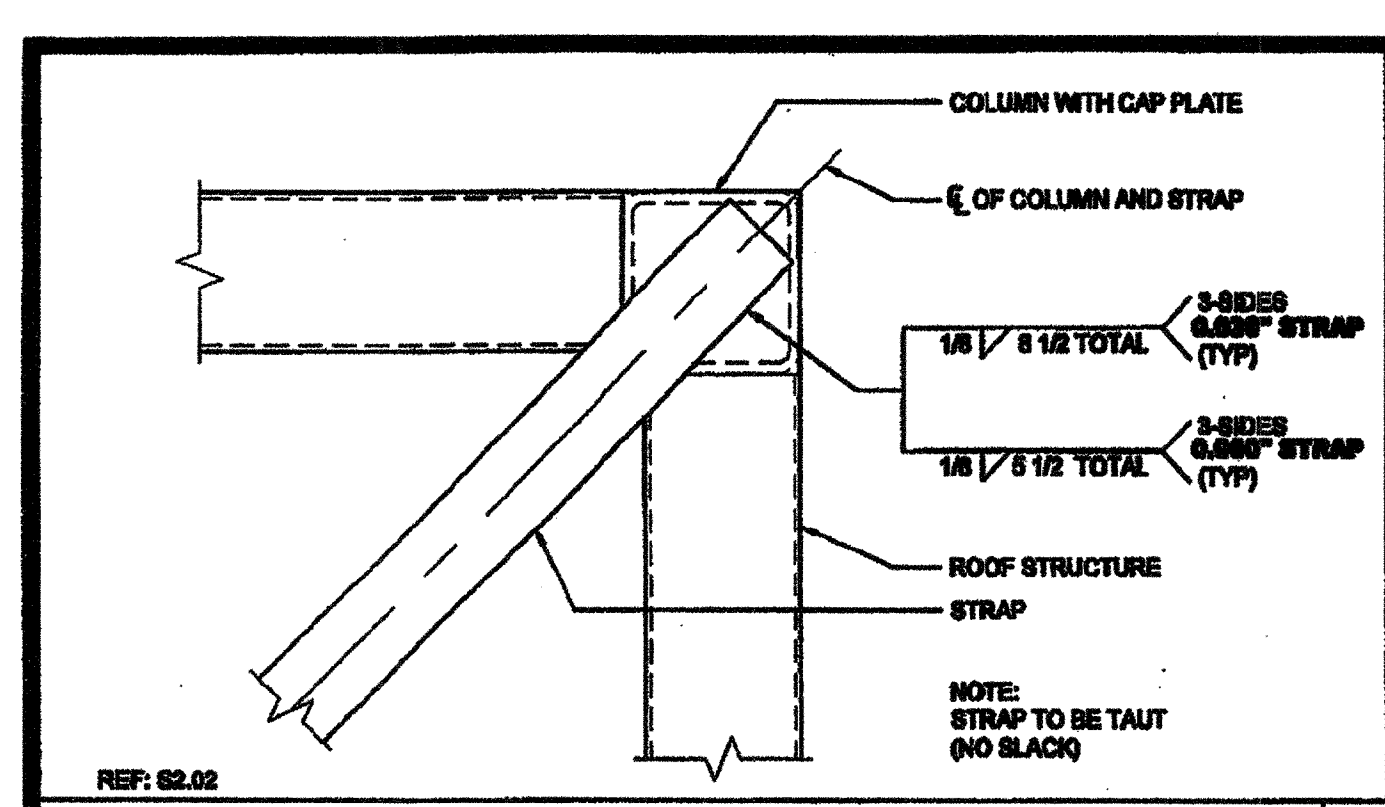

REF: S2.02
ROOF BRACING STRAP @ END WALL SCALE: 3"=1'-0" 16

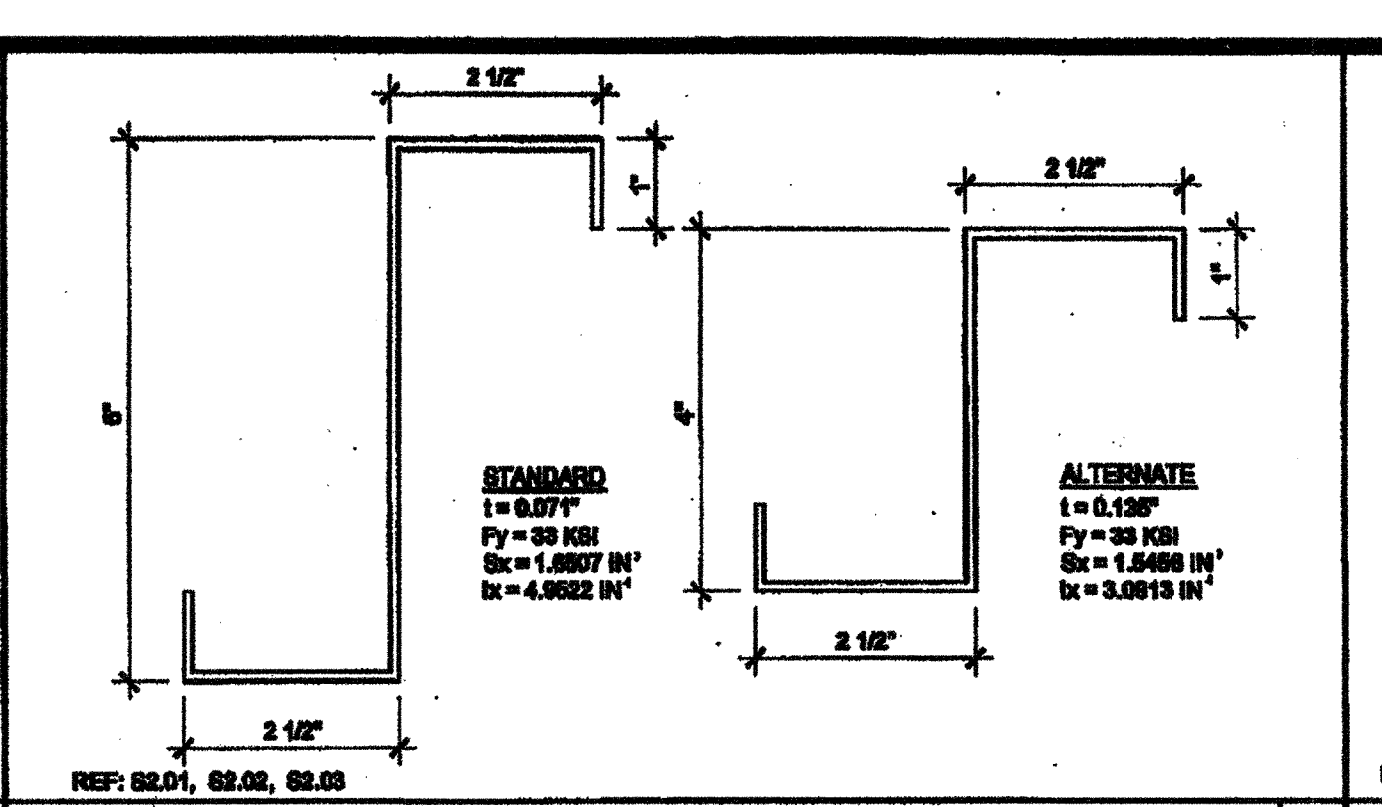

REF: S2.01, S2.02, S2.03
ROOF PURLIN SCALE: 6"=1'-0" 11

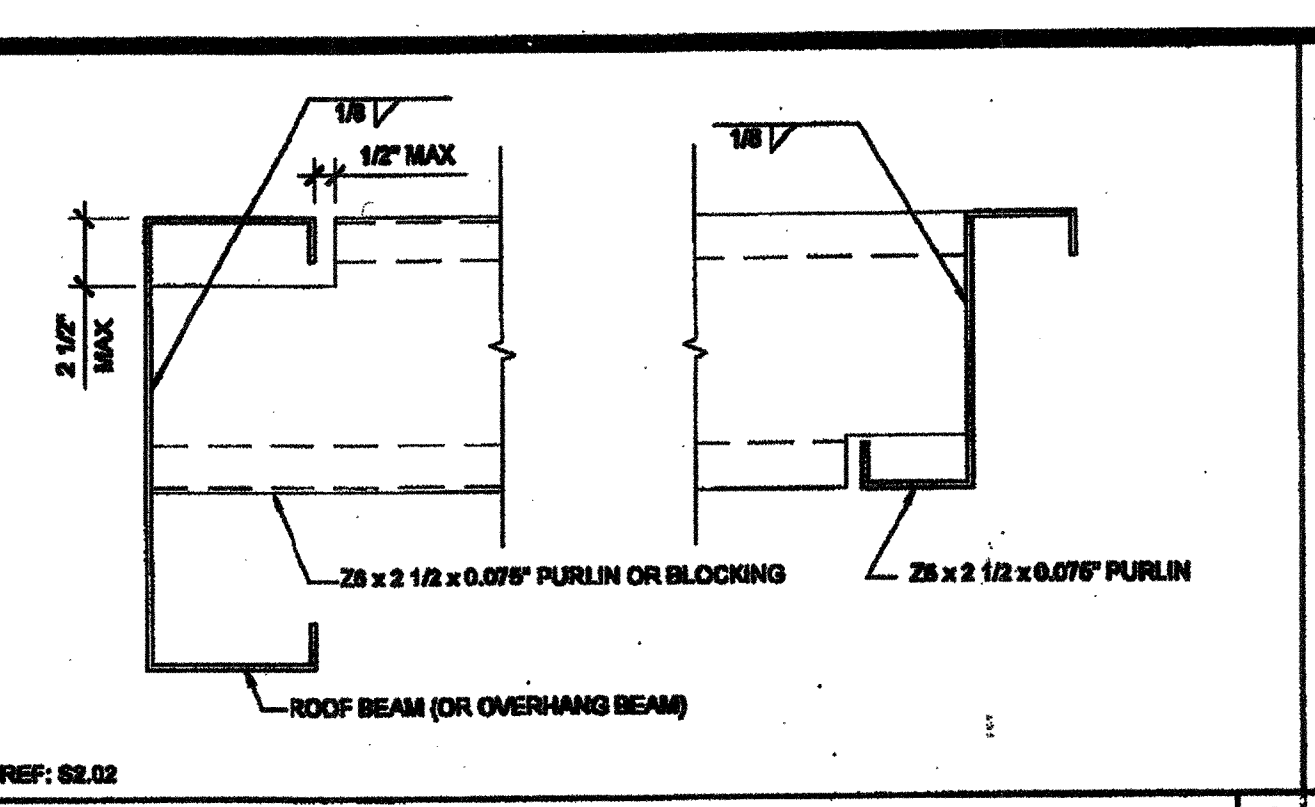

REF: S2.02
PURLIN CONNECTION DETAIL SCALE: 3"=1'-0" 6

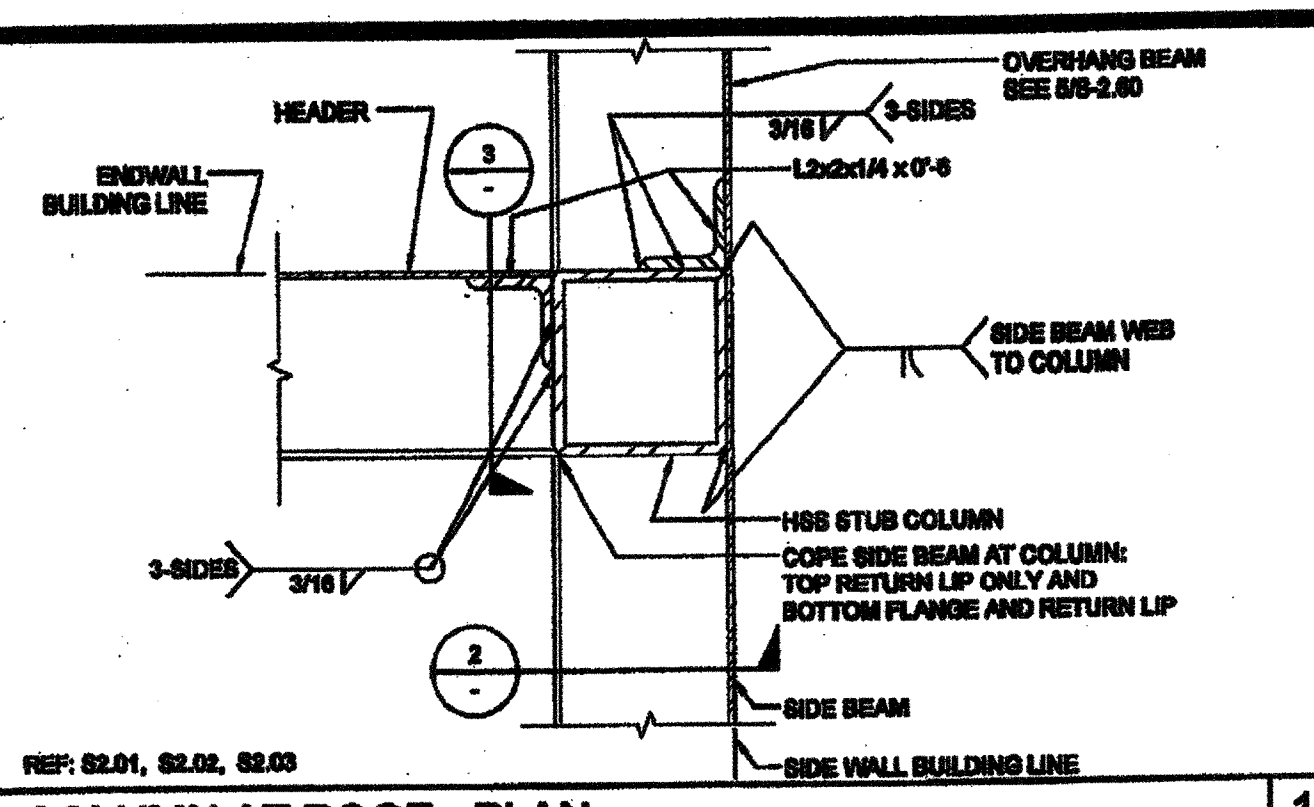

REF: S2.01, S2.02, S2.03
COLUMN AT ROOF - PLAN SCALE: 3"=1'-0" 1

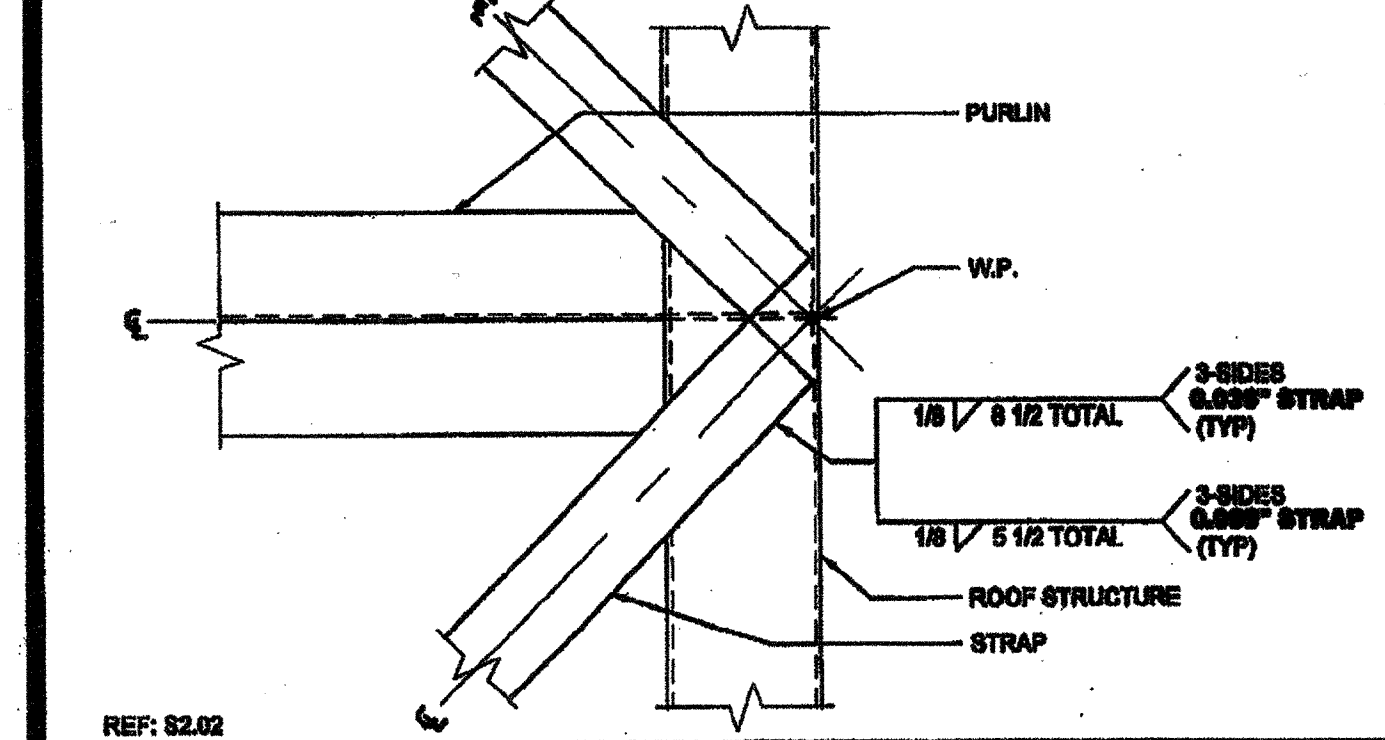

REF: S2.02
ROOF BRACING STRAP @ SIDE WALL SCALE: 3"=1'-0" 17

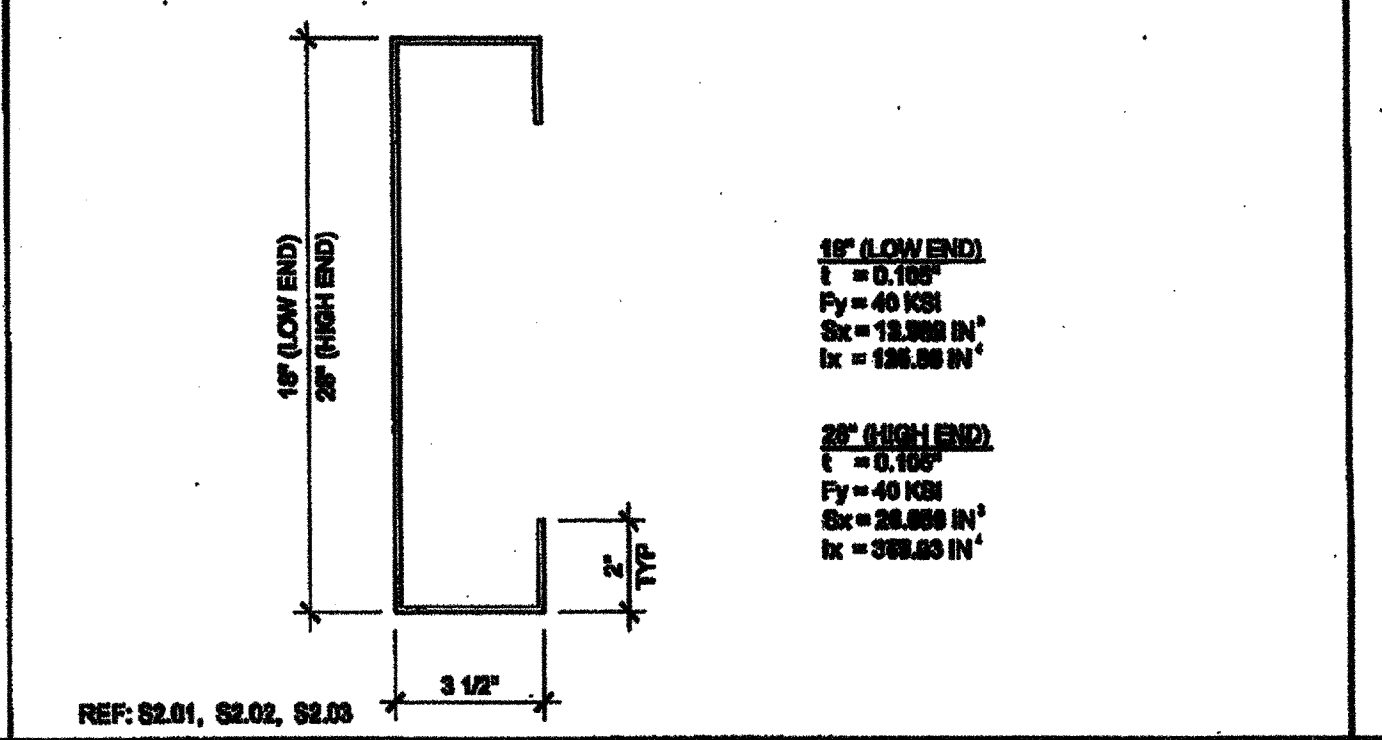

REF: S2.01, S2.02, S2.03
ROOF HEADER SCALE: NTS 12

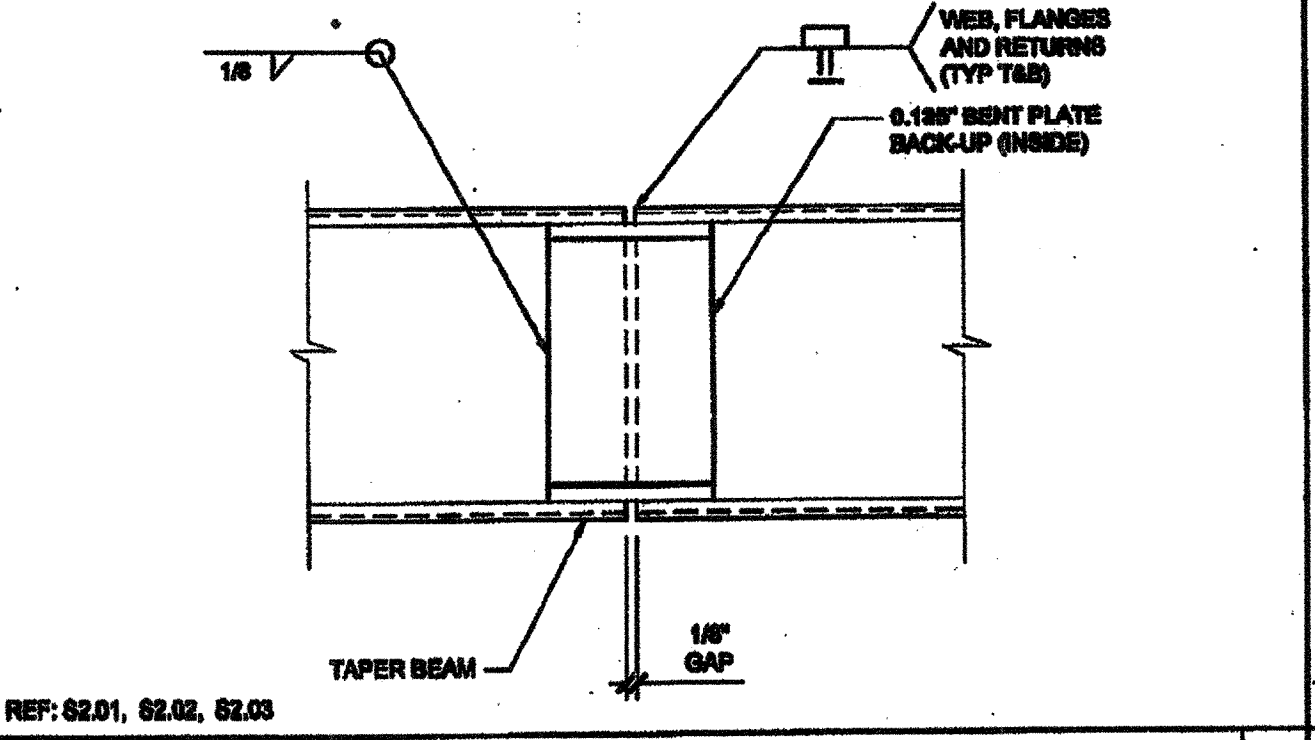

REF: S2.01, S2.02, S2.03
BEAM SPLICE SCALE: 3"=1'-0" 7

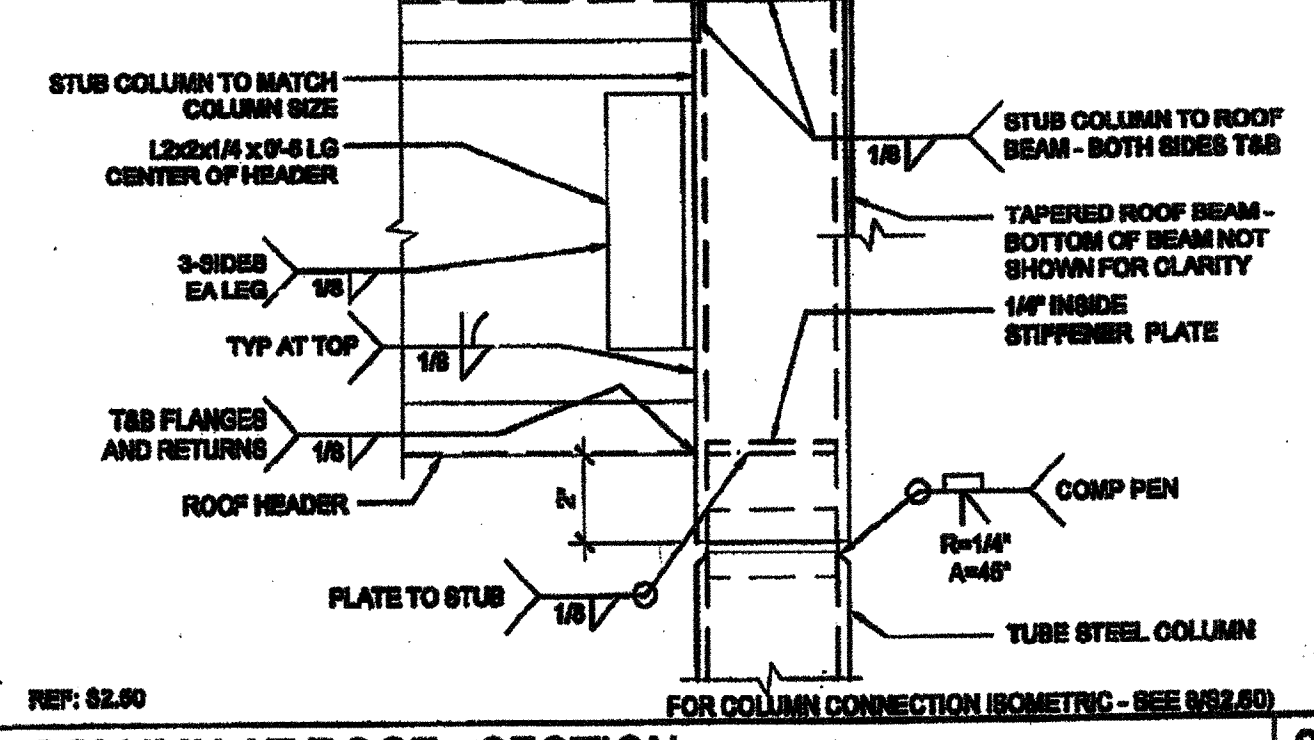

REF: S2.01
COLUMN AT ROOF - SECTION SCALE: 3"=1'-0" 2

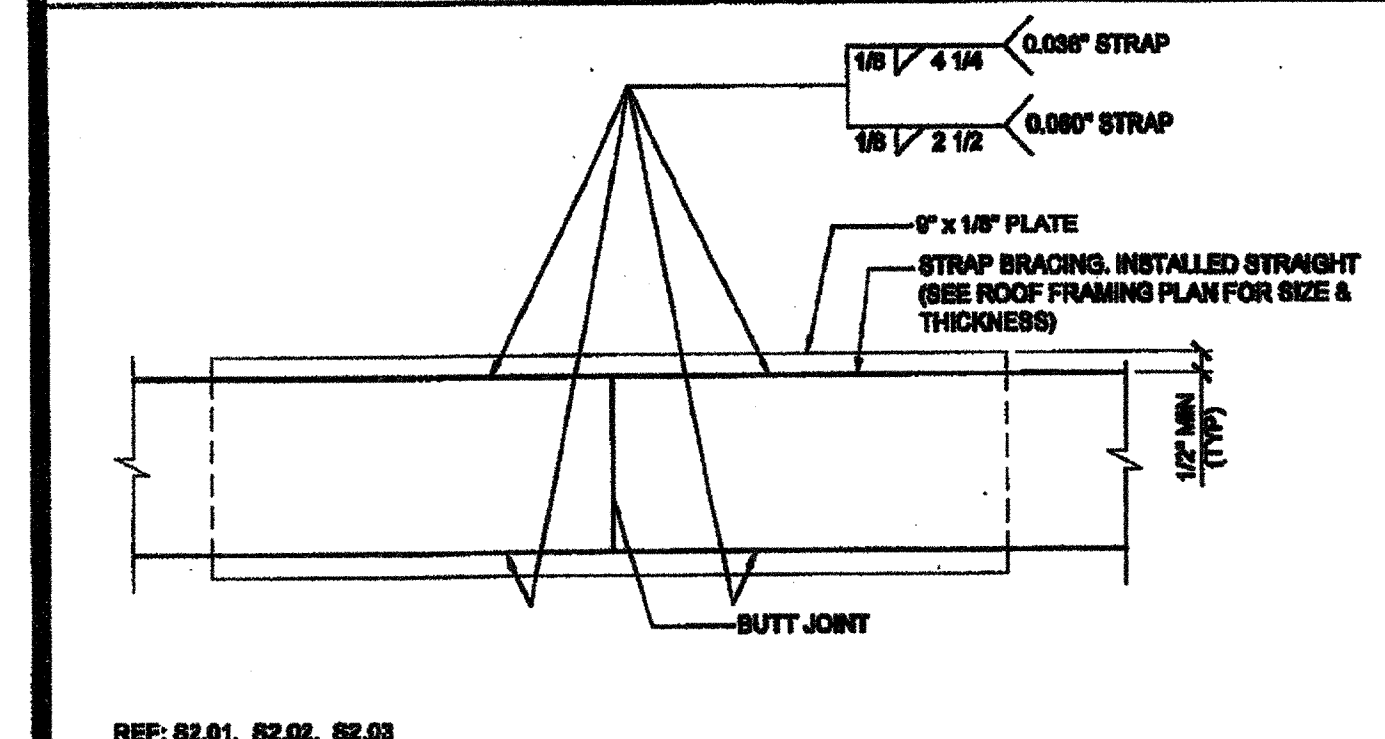

REF: S2.01, S2.02, S2.03
STRAP SPLICE DETAIL SCALE: 6"=1'-0" 18

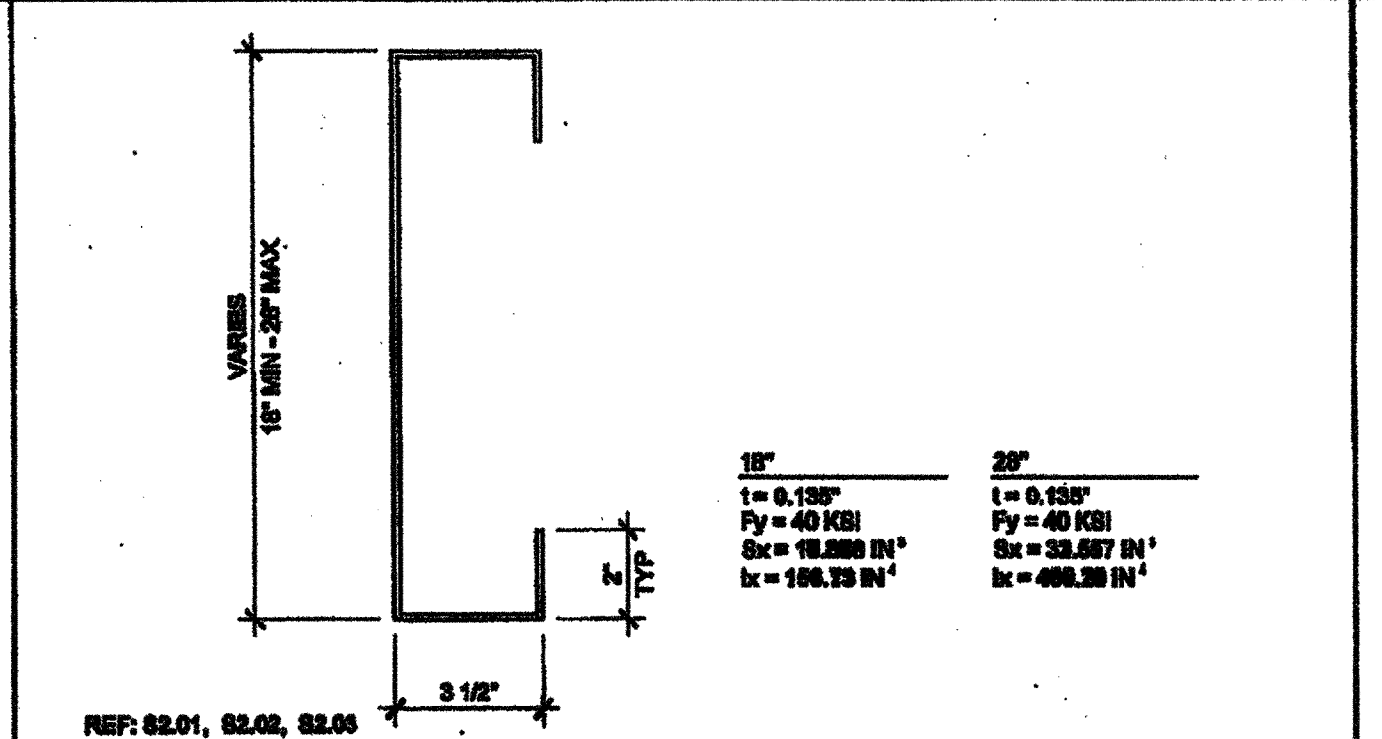

REF: S2.01, S2.02, S2.03
SIDE BEAM SCALE: NTS 13

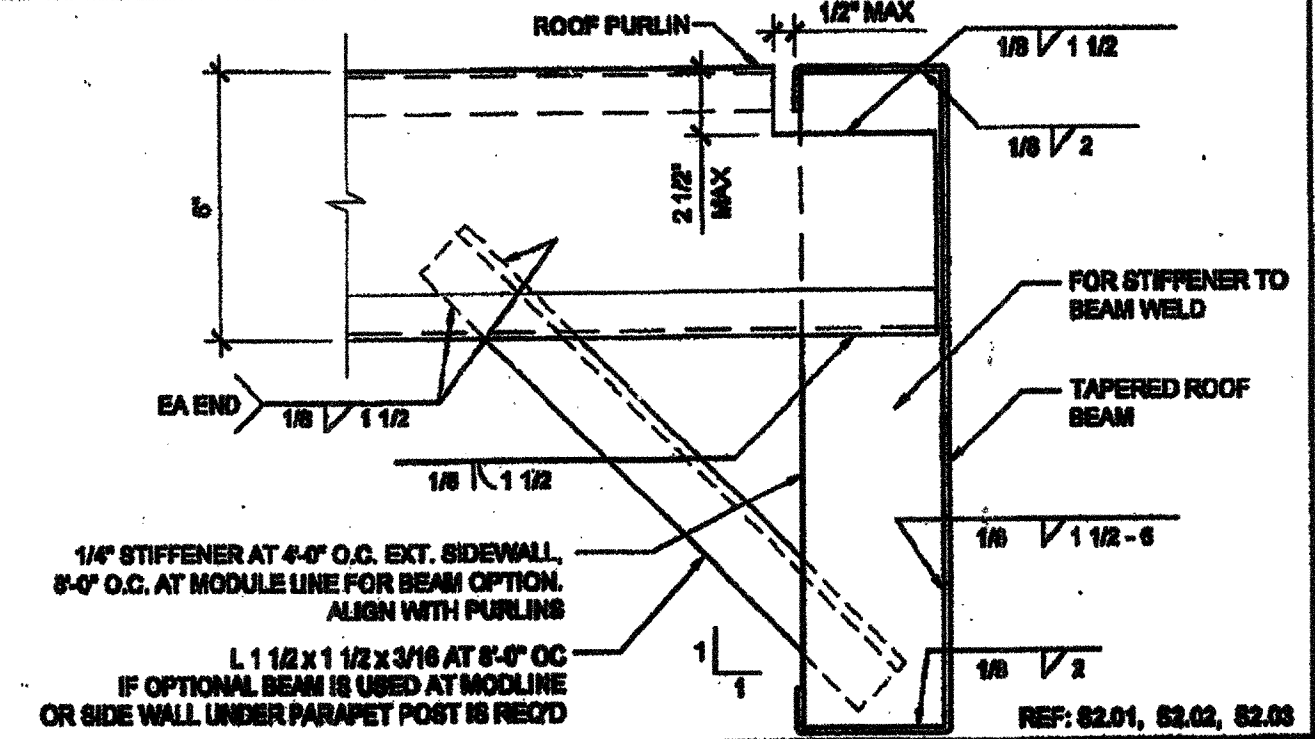

REF: S2.01, S2.02, S2.03
PURLIN TO ROOF BEAM @ STIFFENER SCALE: 3"=1'-0" 8

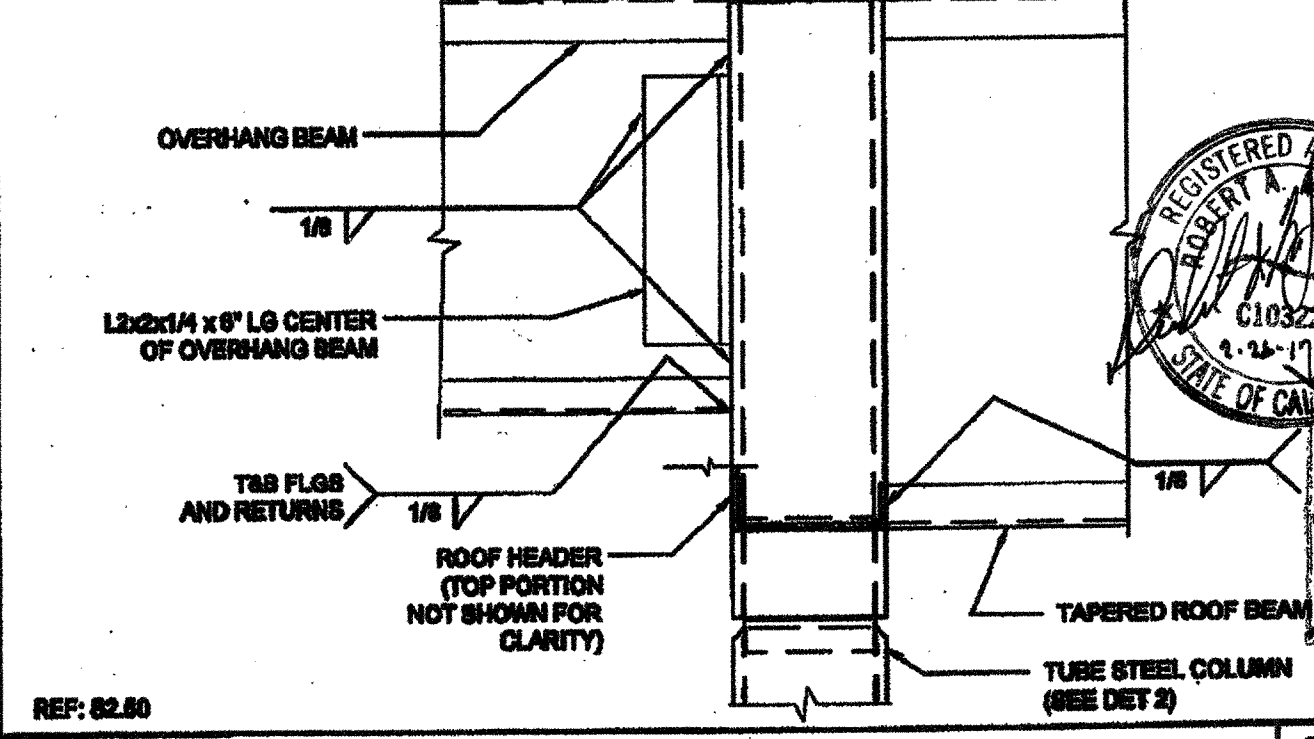

REF: S2.01
COLUMN AT ROOF OVERHANG SCALE: 3"=1'-0" 3

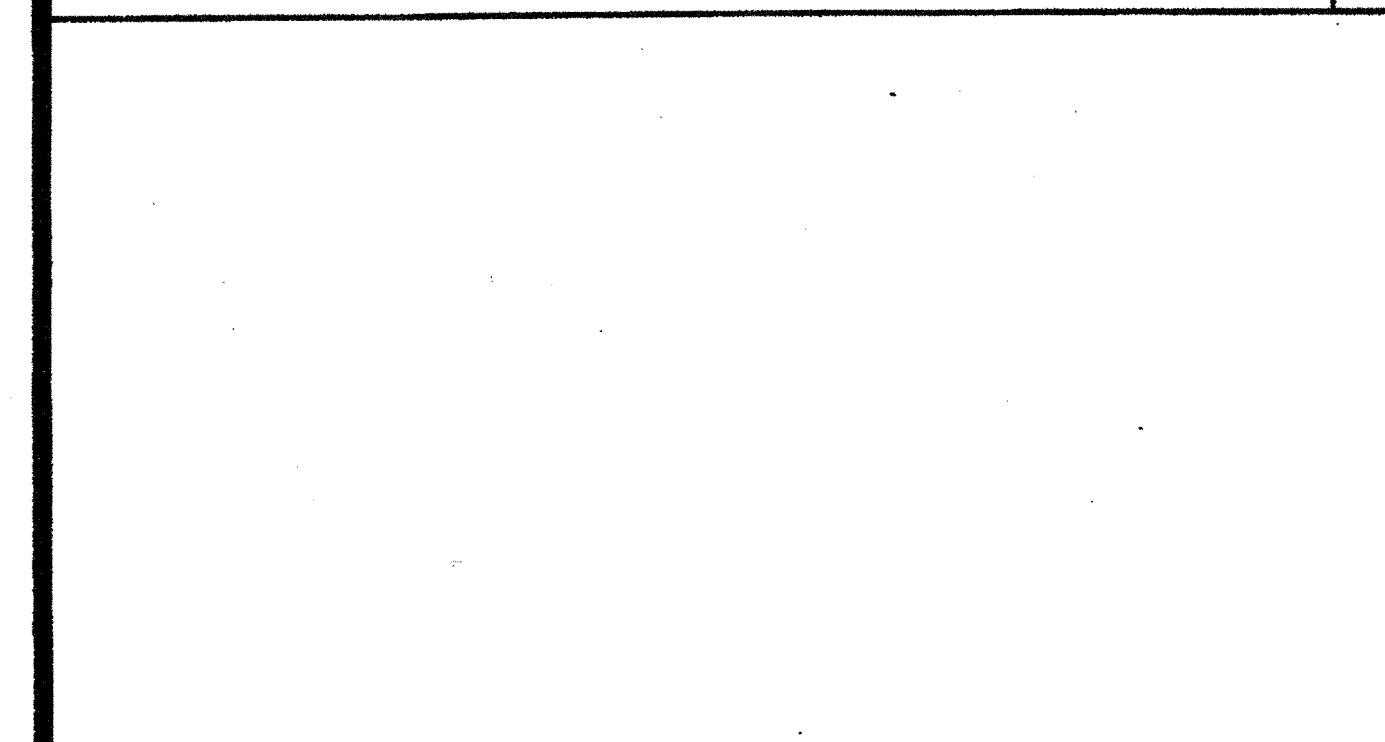

REF: S2.01, S2.02, S2.03
SIDEWALL BEAM PENETRATION SCALE: 1 1/2"=1'-0" 19

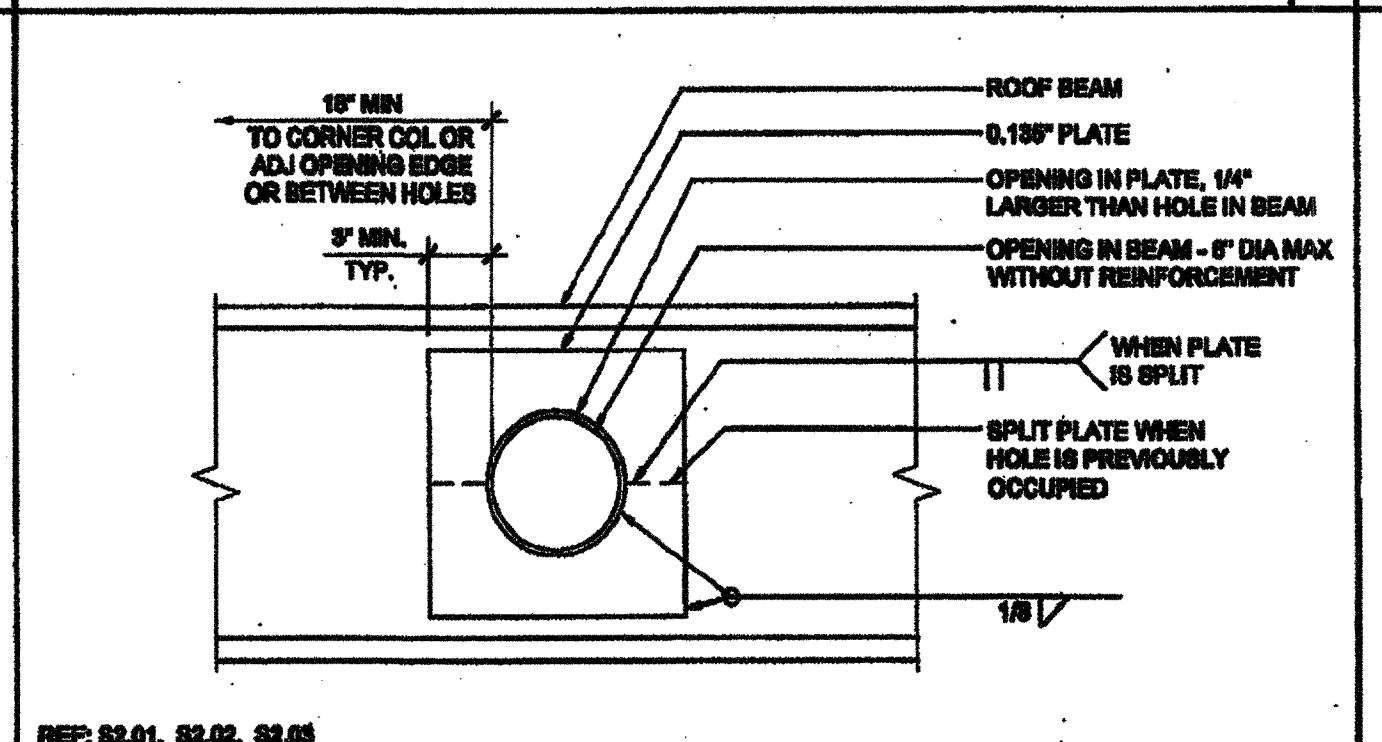

REF: S2.01, S2.02, S2.03
MODULE CONNECTION AT ROOF (OPTION) SCALE: 3"=1'-0" 9

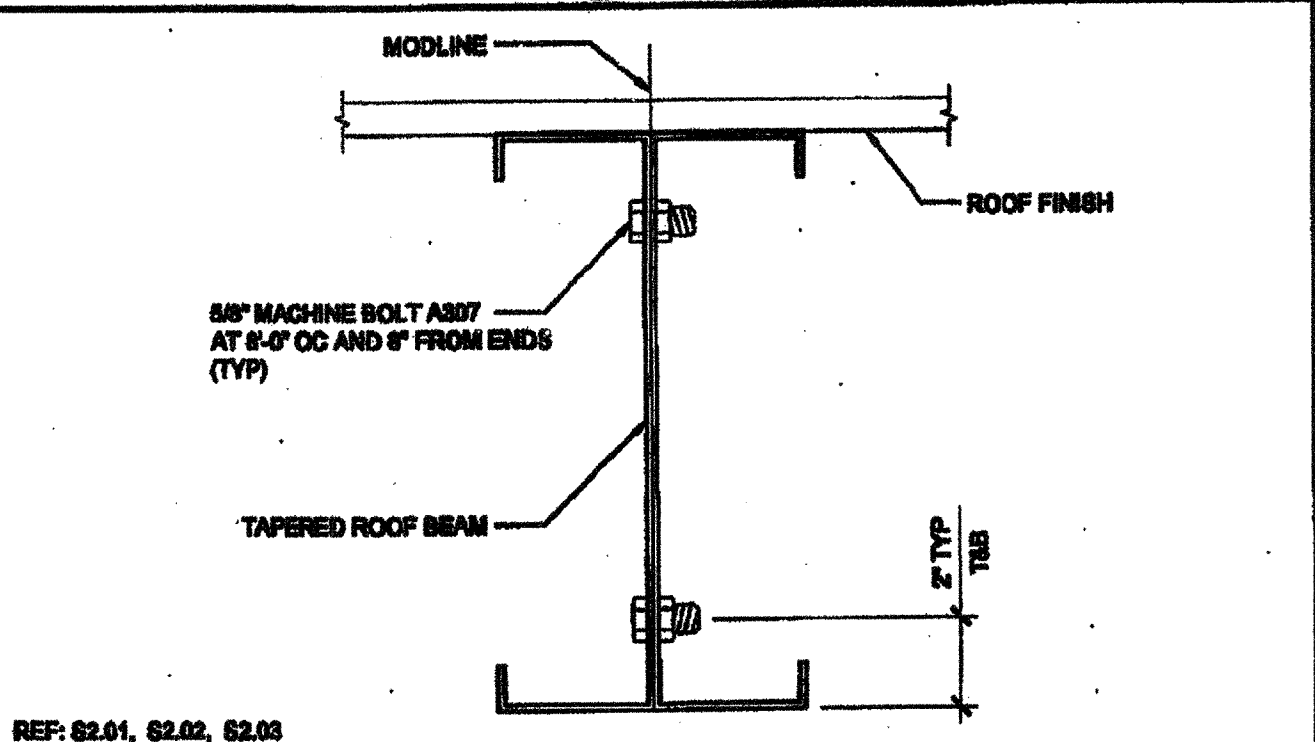

REF: S2.01, S2.02, S2.03
NOT USED SCALE: 1 1/2"=1'-0" 4

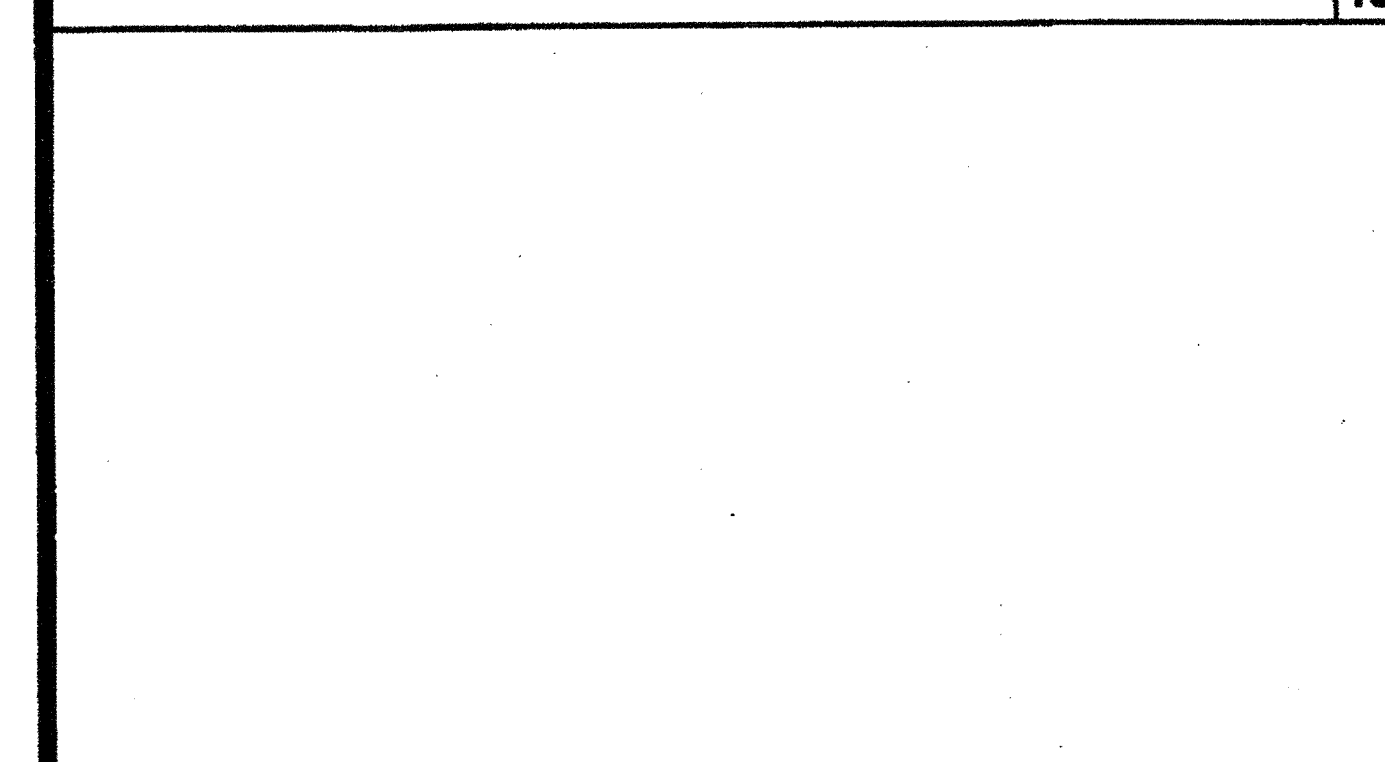

REF: S2.01, S2.02, S2.03, S2.50
WEB OPENING AT ROOF BEAM (OPTION) SCALE: 3"=1'-0" 15

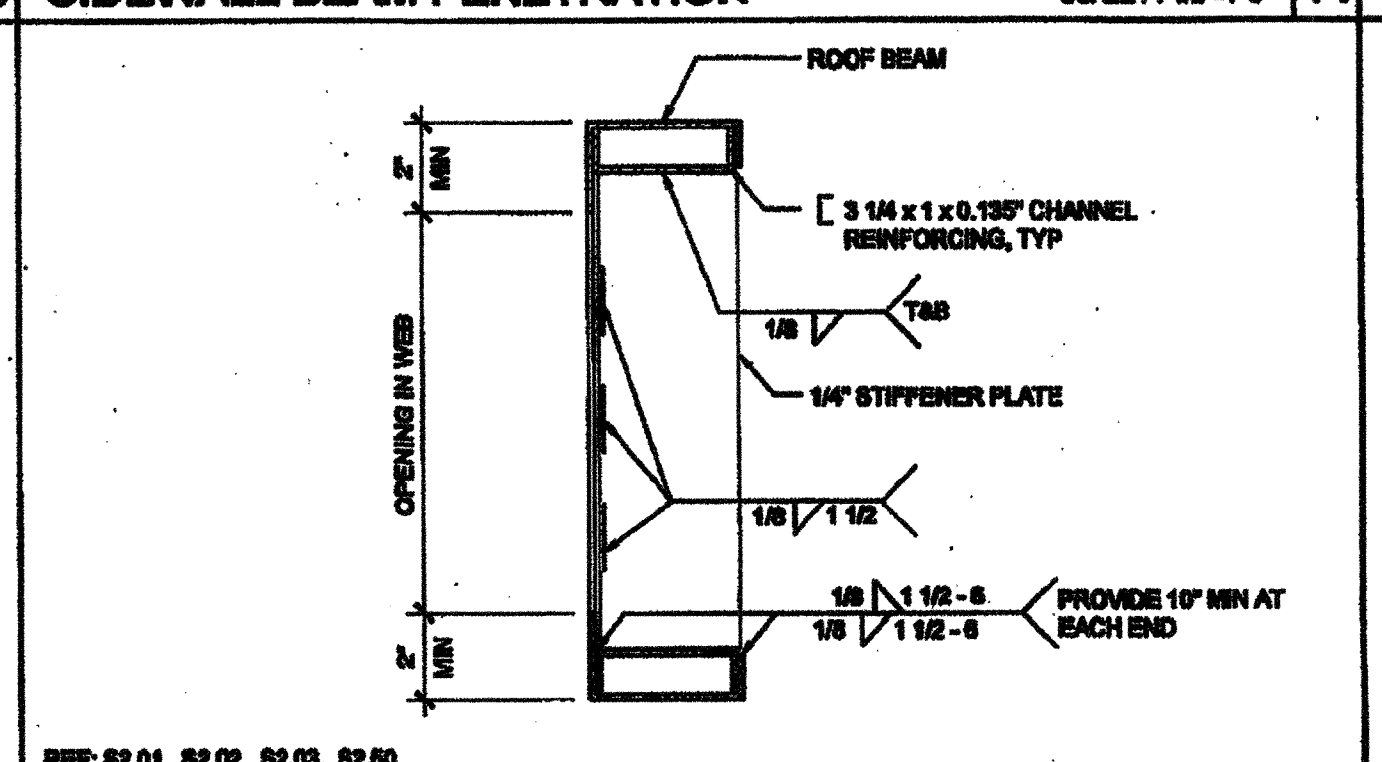

REF: S2.01, S2.02, S2.03
OPENING AT ROOF BEAM (OPTION) SCALE: 1 1/2"=1'-0" 10

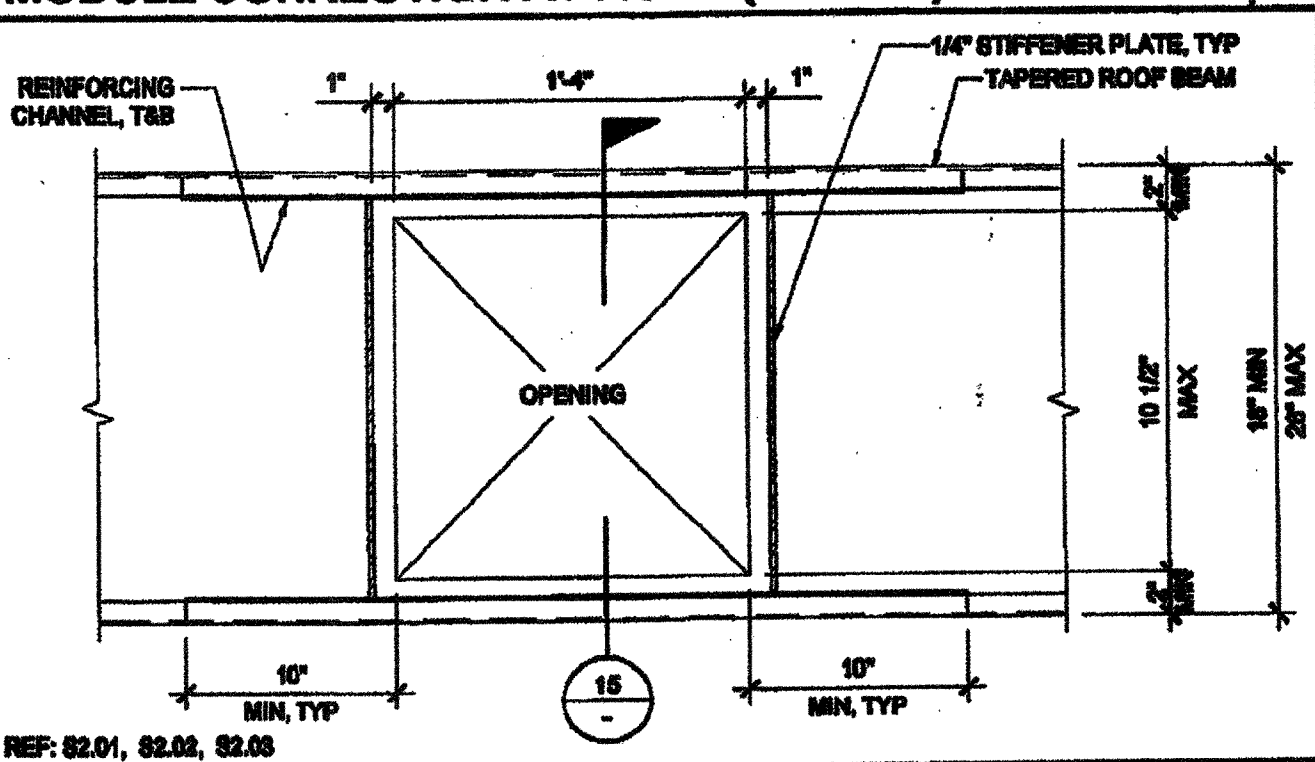

REF: S2.01, S2.02, S2.03
OPENING AT HEADER SCALE: 1 1/2"=1'-0" 5