

THESE DRAWINGS AND ALL MATERIAL CONTAINED HEREIN ARE THE PROPERTY OF SILVER CREEK INDUSTRIES, INC. (SCI) AND SHALL NOT BE REPRODUCED, COPIED OR OTHERWISE DISPOSED OF DIRECTLY OR INDIRECTLY AND SHALL NOT BE USED IN WHOLE OR IN PART TO ASSIST IN THE MAKING OF OR FOR THE PURPOSE OF FURNISHING ANY INFORMATION FOR THE MAKING OF DRAWINGS, PRINTS, APPARATUS OR PARTS THEREOF WITHOUT THE FULL KNOWLEDGE AND WRITTEN CONSENT OF SCI INC. ALL PATENTABLE MATERIAL CONTAINED HEREIN AND ORIGINATING WITH SCI INC SHALL BE THE PROPERTY OF SCI INC.

SILVER CREEK INDUSTRIES, INC.



195 EAST MORGAN FERRIS, CALIFORNIA 92571  
PHONE: 951-943-8399 FAX: 951-943-2211

PROJECT NAME:  
**CLASS LEASING CLASSROOMS BLDG'S**

SHEET TITLE:  
**ARCHITECTURAL DETAILS  
WOOD STUD - PLASTER**

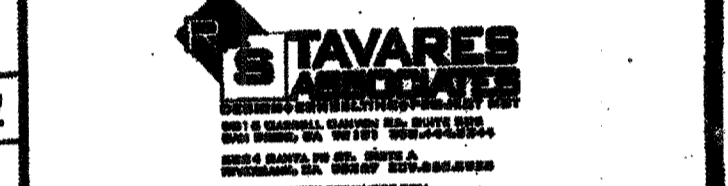

ARCHITECT OF RECORD  
12/23/2011

REGISTERED ARCHITECT  
STATE OF CALIFORNIA  
C10322  
A. S. S. S. S. S.

REGISTERED ARCHITECT  
STATE OF CALIFORNIA  
C10322  
A. S. S. S. S. S.

PROJECT SPECIFIC STATE AGENCY APPROVAL

IDENTIFICATION STAMP  
DIV. OF THE STATE ARCHITECT  
OFFICE OF REGULATION SERVICES  
04 113892  
AC: RLS  
DATE: FEB 25 2015

ORIGINAL PC STATE AGENCY APPROVAL

IDENTIFICATION STAMP  
DIV. OF THE STATE ARCHITECT  
OFFICE OF REGULATION SERVICES  
04 114277  
AC: RLS  
DATE: APR 23 2015

REVISIONS

SILVER CREEK INDUSTRIES  
24' x 40' PC

PROJECT NO:  
DRAWN BY:  
SCALE: AS NOTED  
DATE: 12-23-11

P.C. SHEET NUMBER  
**SKP 140**

**A-5.11**

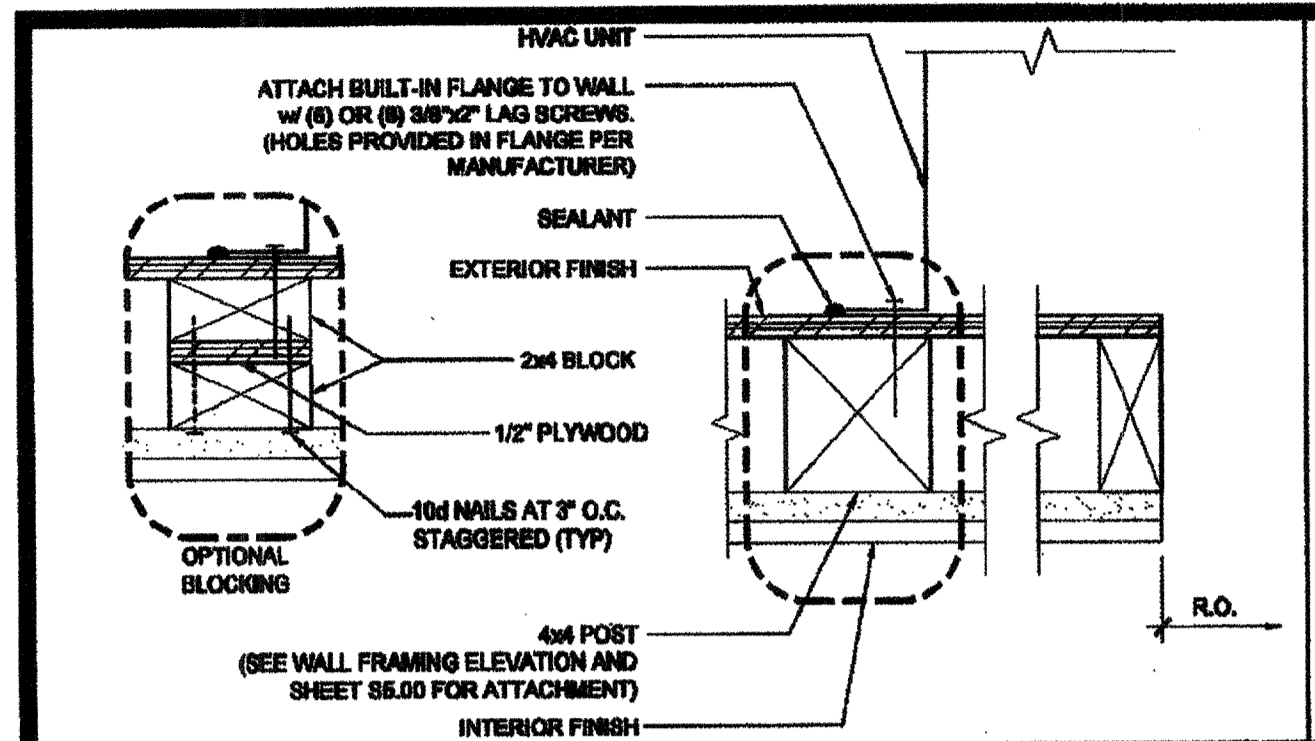

HVAC MOUNT AT JAMBS SCALE: 3/4"=1'-0" 16

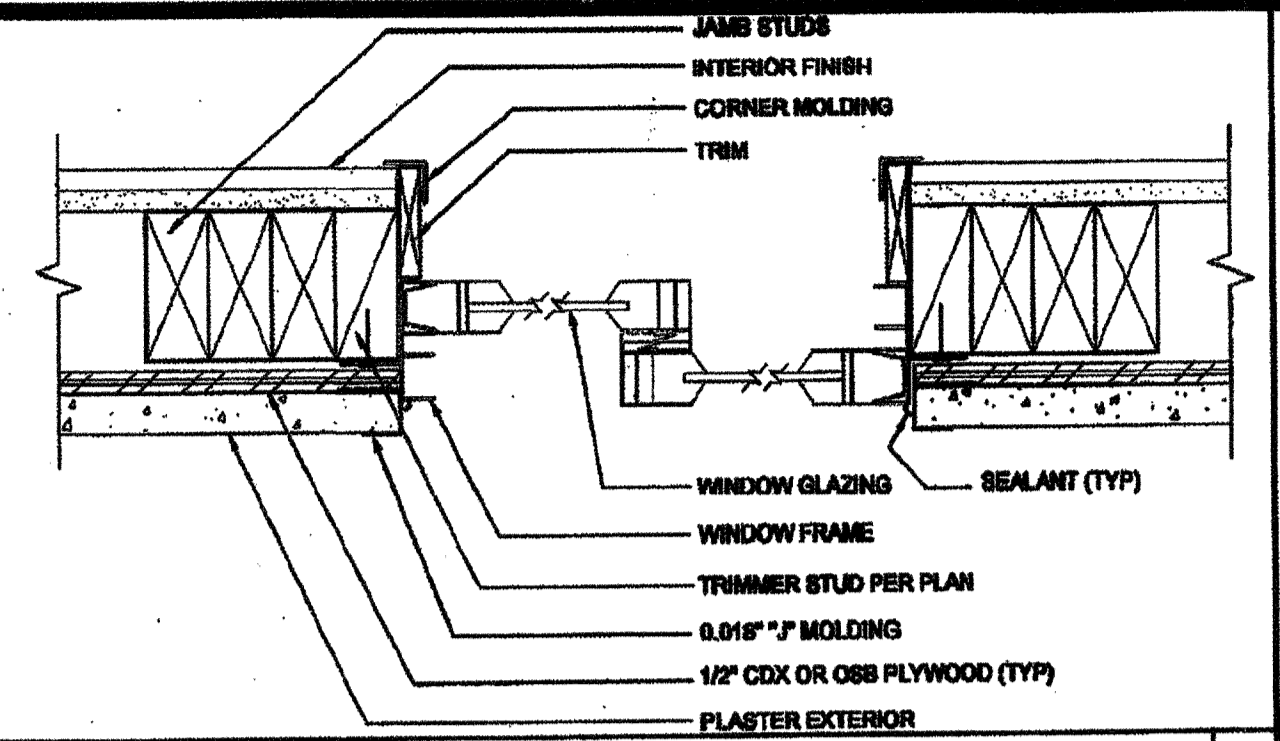

WINDOW SECTION AT JAMBS SCALE: 3/4"=1'-0" 11

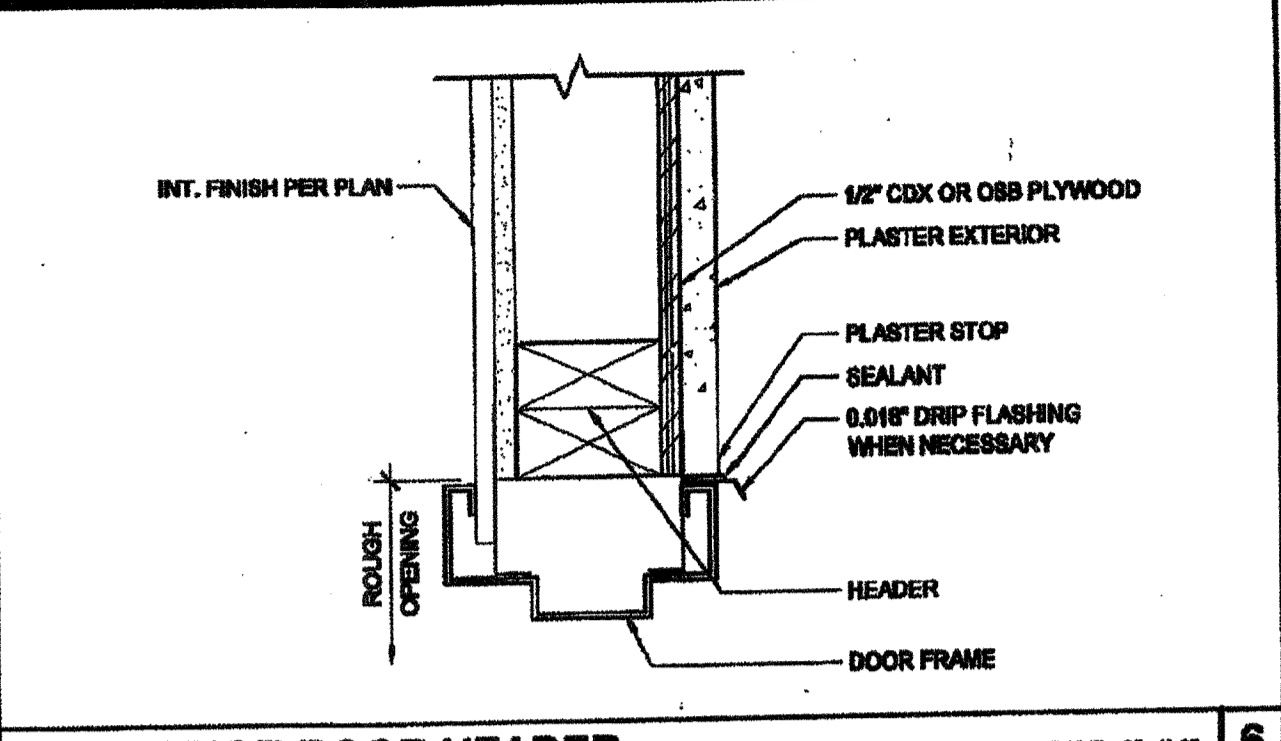

EXTERIOR DOOR HEADER SCALE: 3/4"=1'-0" 6

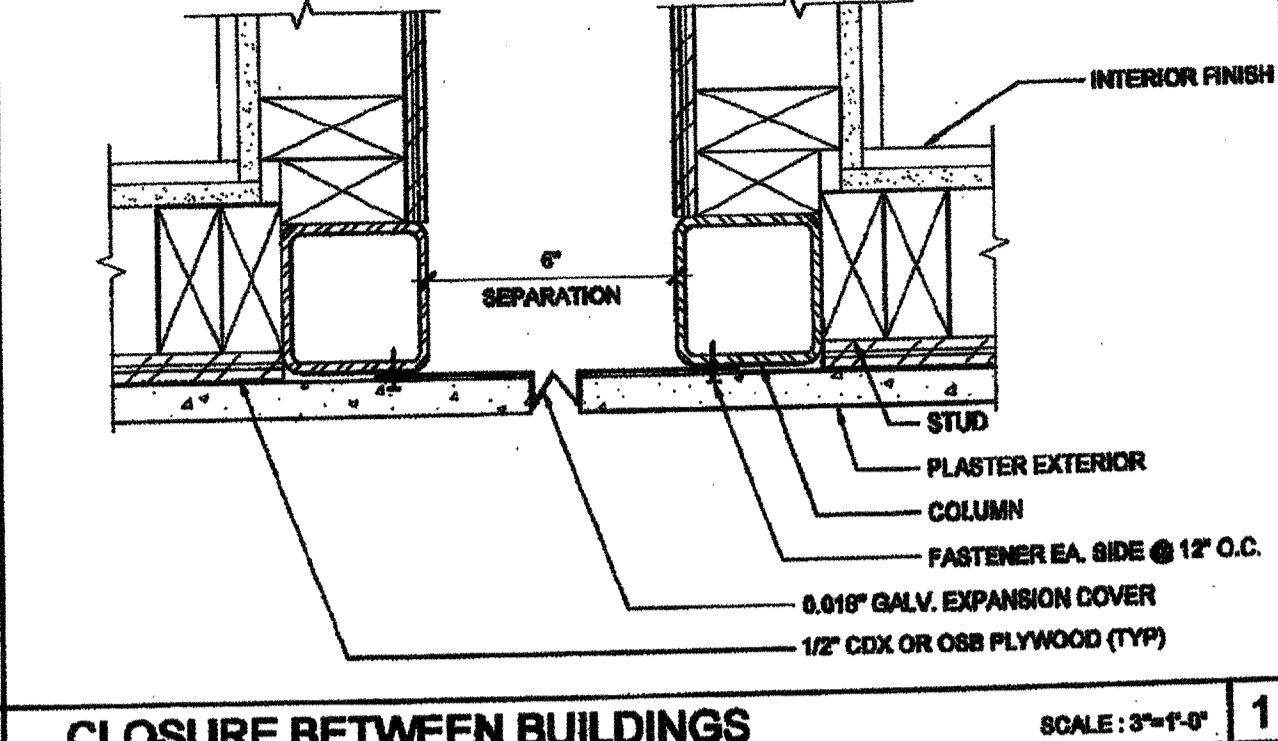

CLOSURE BETWEEN BUILDINGS SCALE: 3/4"=1'-0" 1

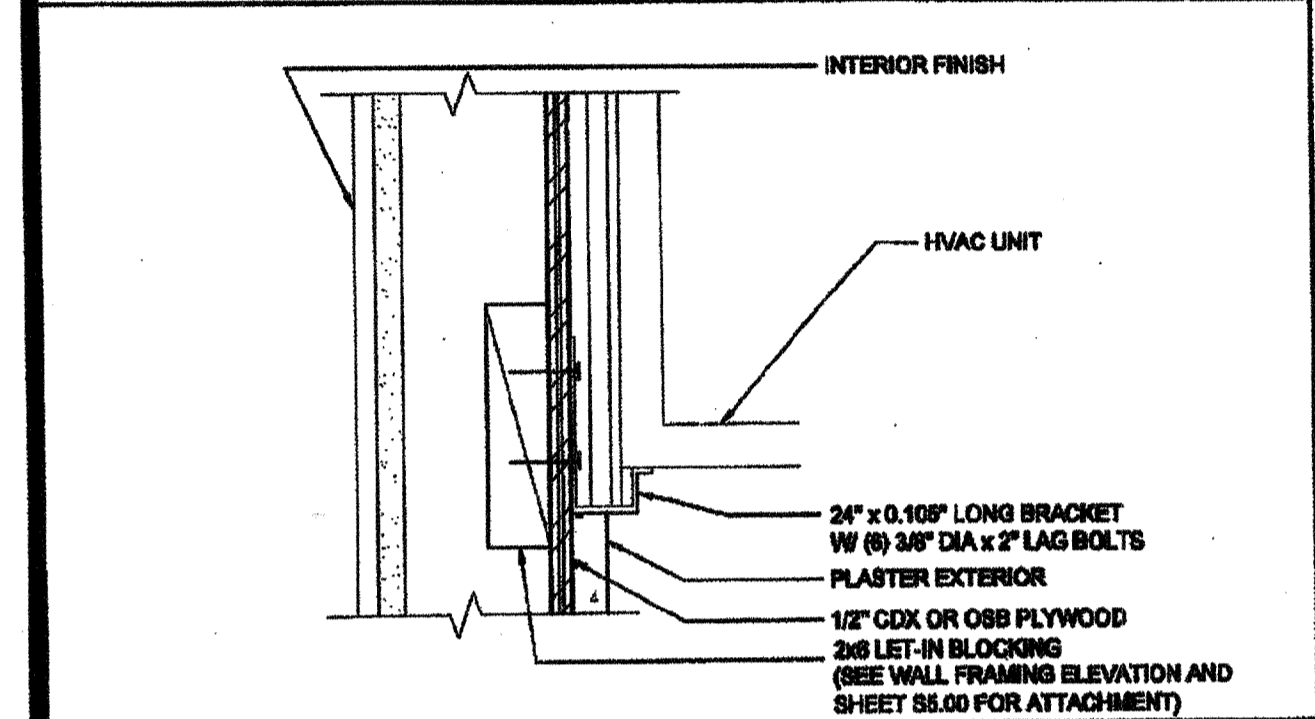

HVAC UNIT AT BOTTOM SCALE: 3/4"=1'-0" 17

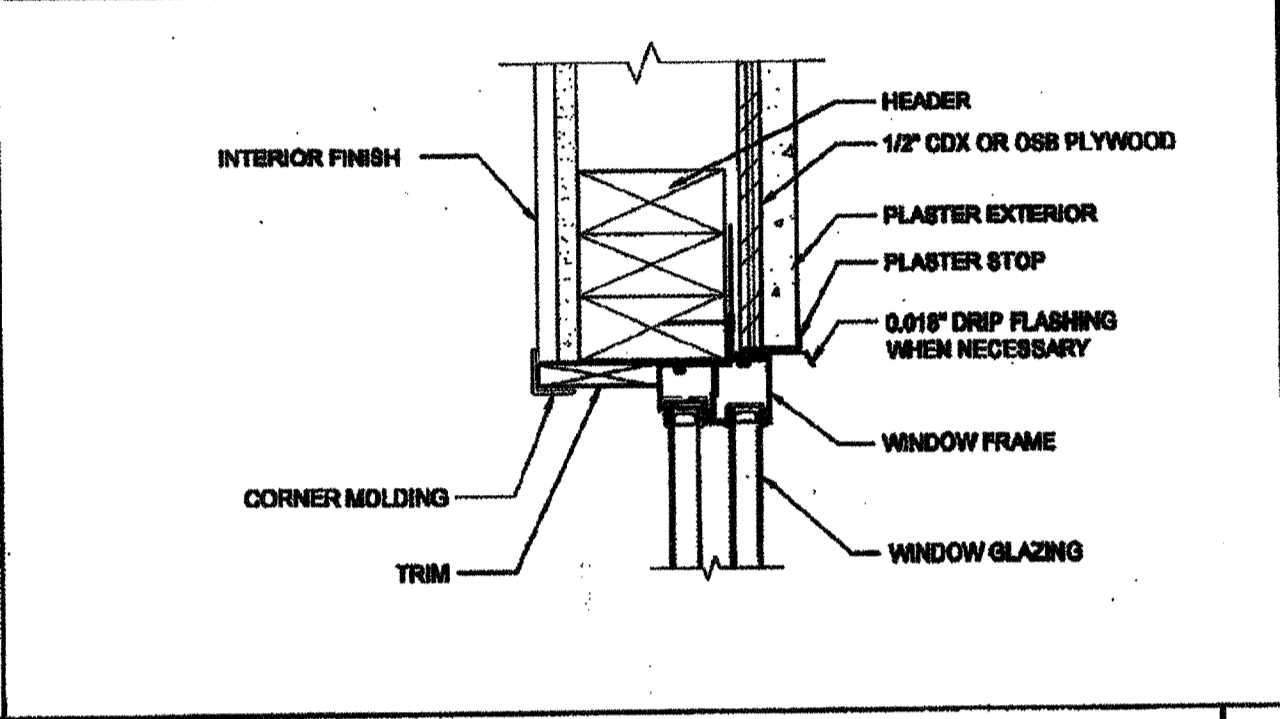

WINDOW HEADER SCALE: 3/4"=1'-0" 12

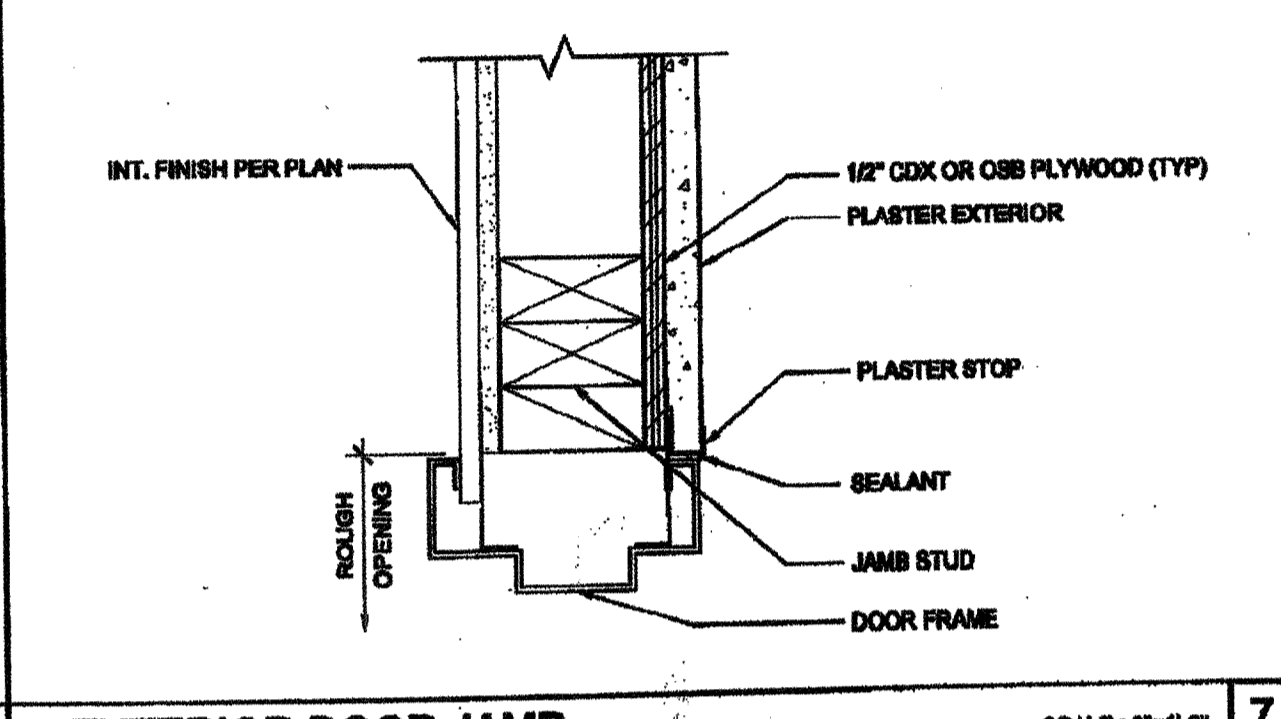

EXTERIOR DOOR JAMB SCALE: 3/4"=1'-0" 7

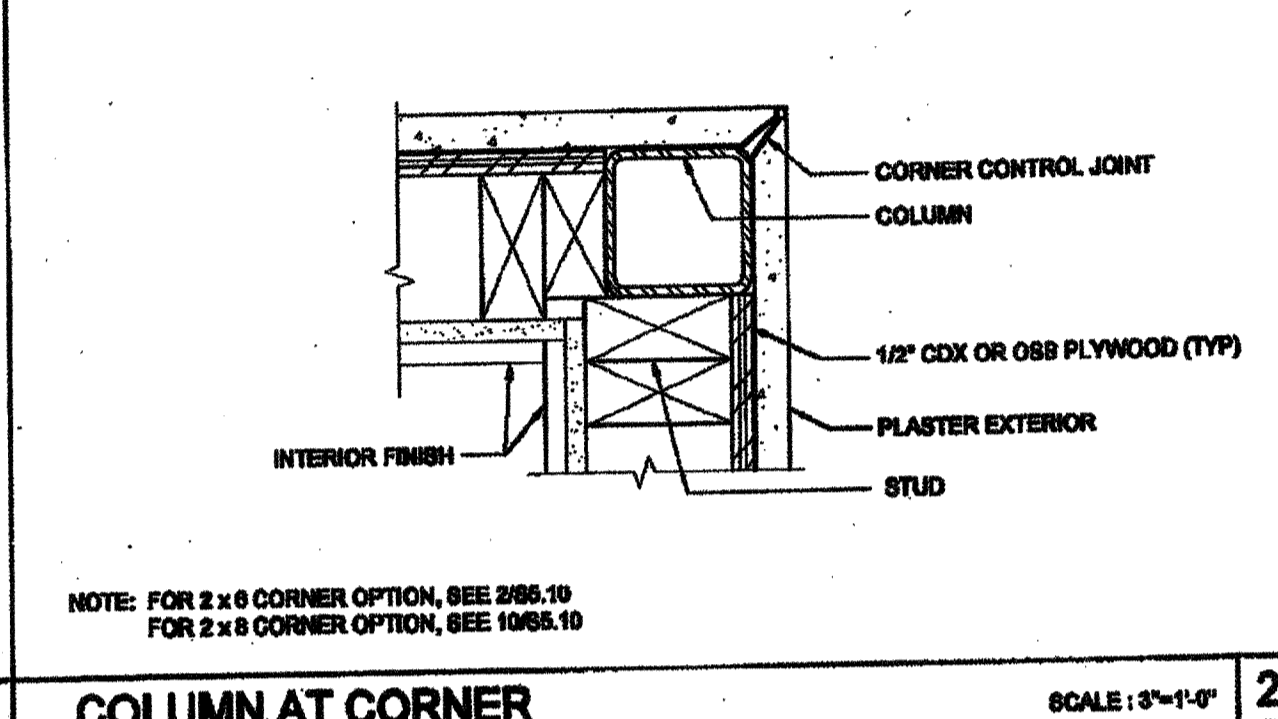

COLUMN AT CORNER SCALE: 3/4"=1'-0" 2

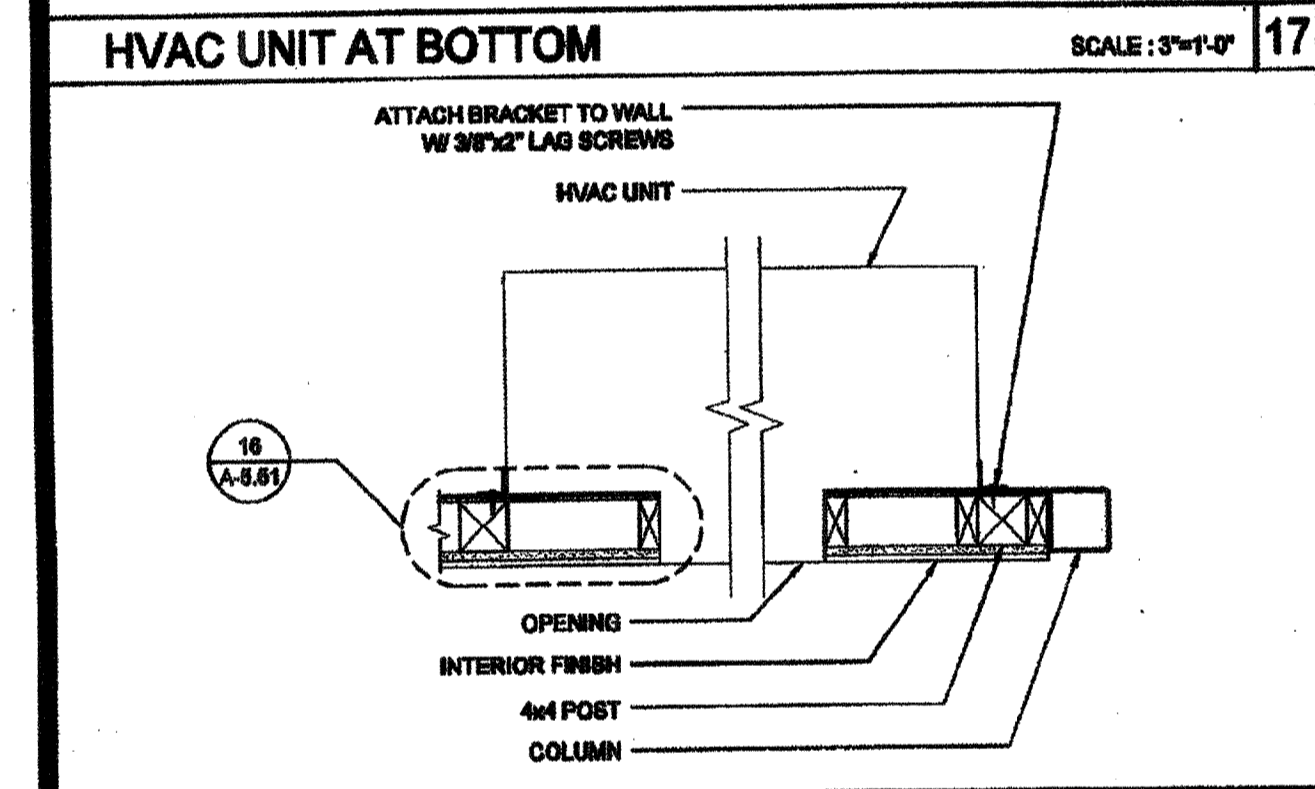

HVAC UNIT (PLAN) SCALE: 1/2"=1'-0" 18

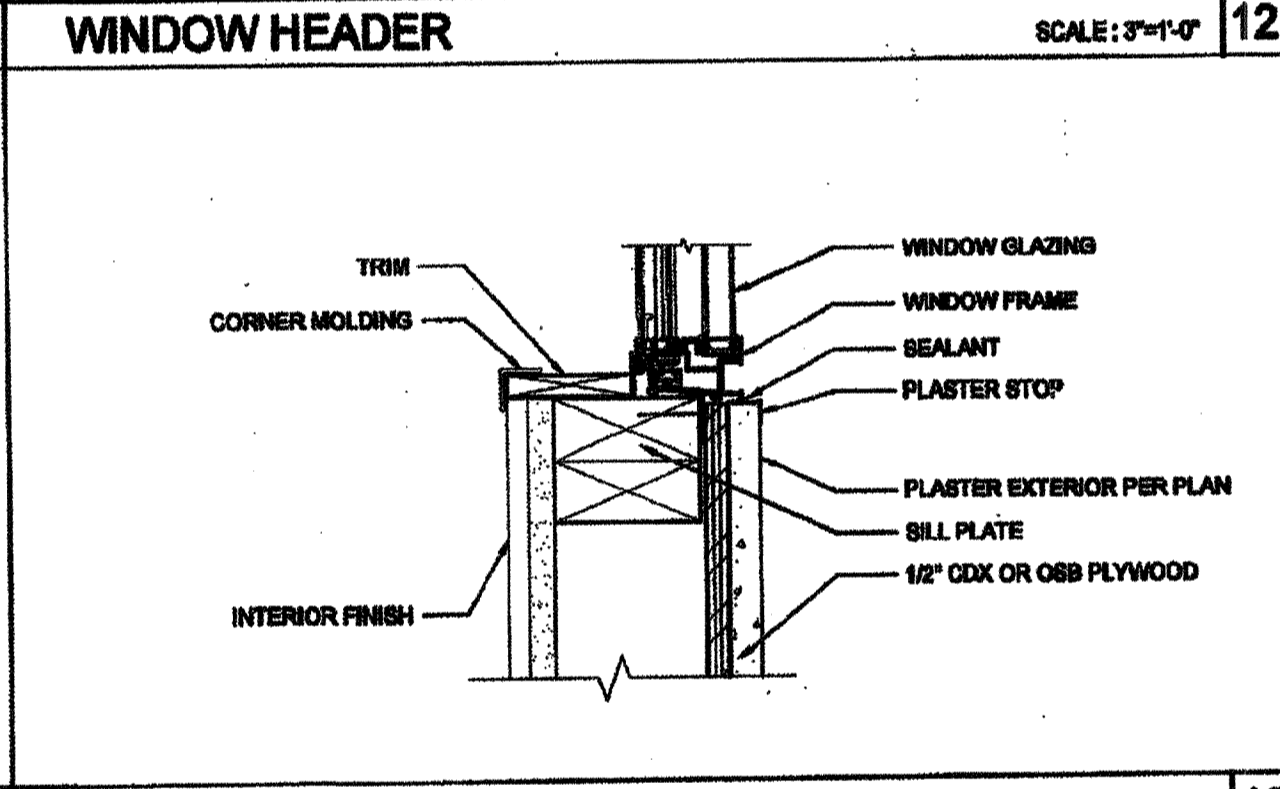

WINDOW SILL SCALE: 3/4"=1'-0" 13

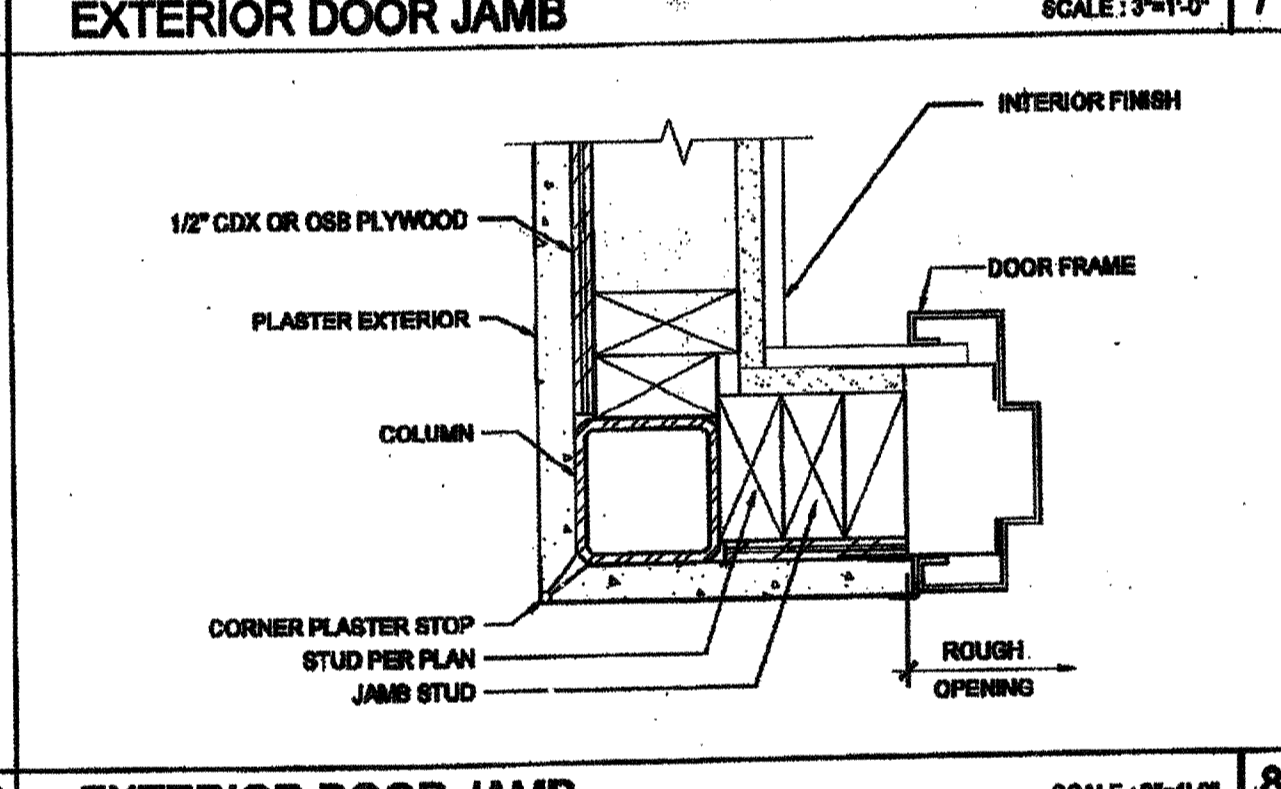

EXTERIOR DOOR JAMB SCALE: 3/4"=1'-0" 8

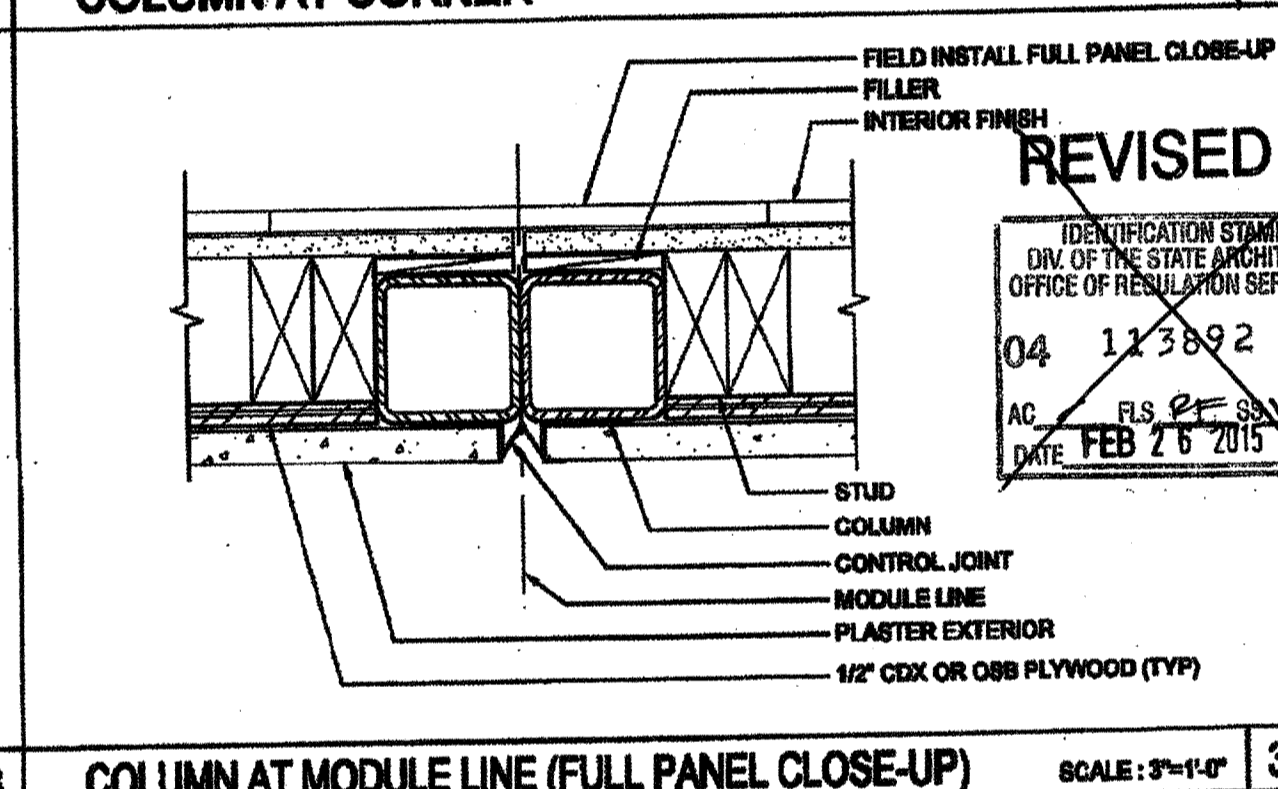

COLUMN AT MODULE LINE (FULL PANEL CLOSE-UP) SCALE: 3/4"=1'-0" 3

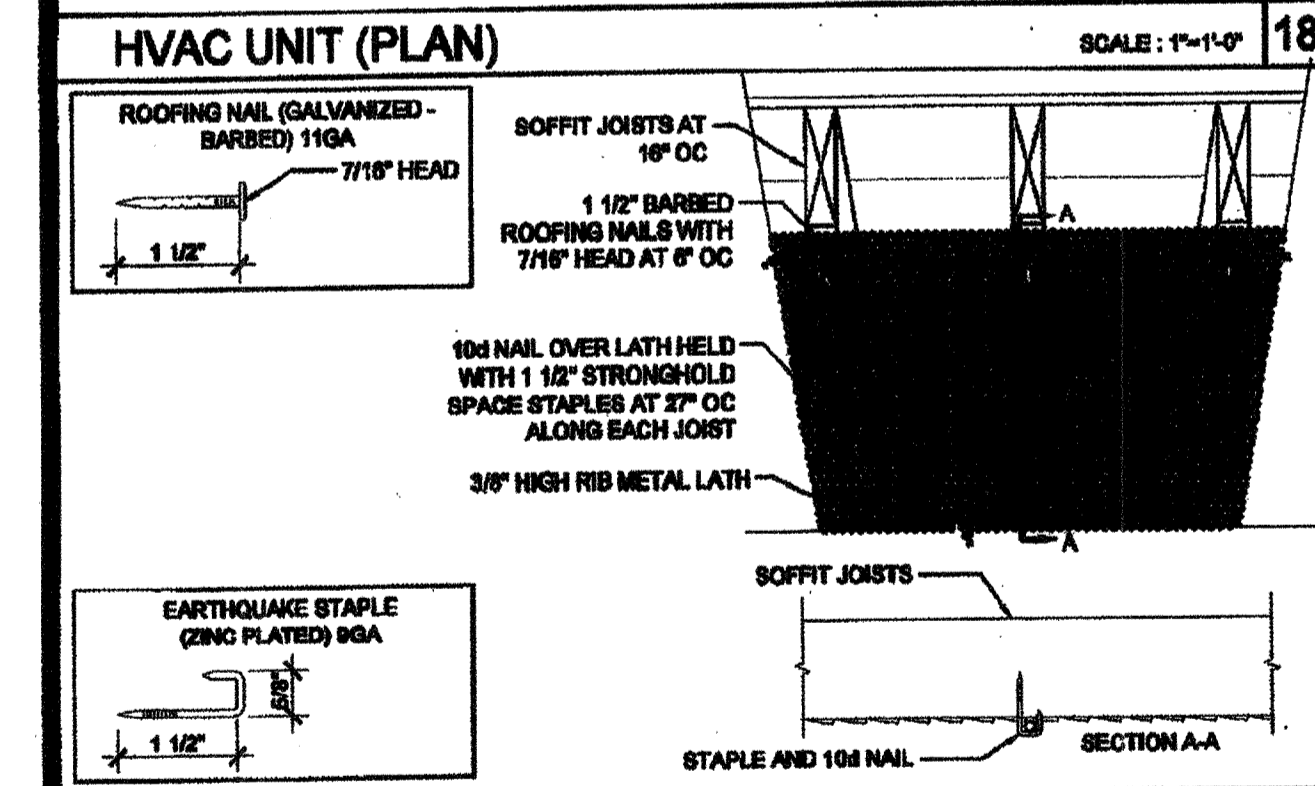

METAL LATH ATTACHMENT TO WOOD JOIST SCALE: 1 1/2"=1'-0" 19

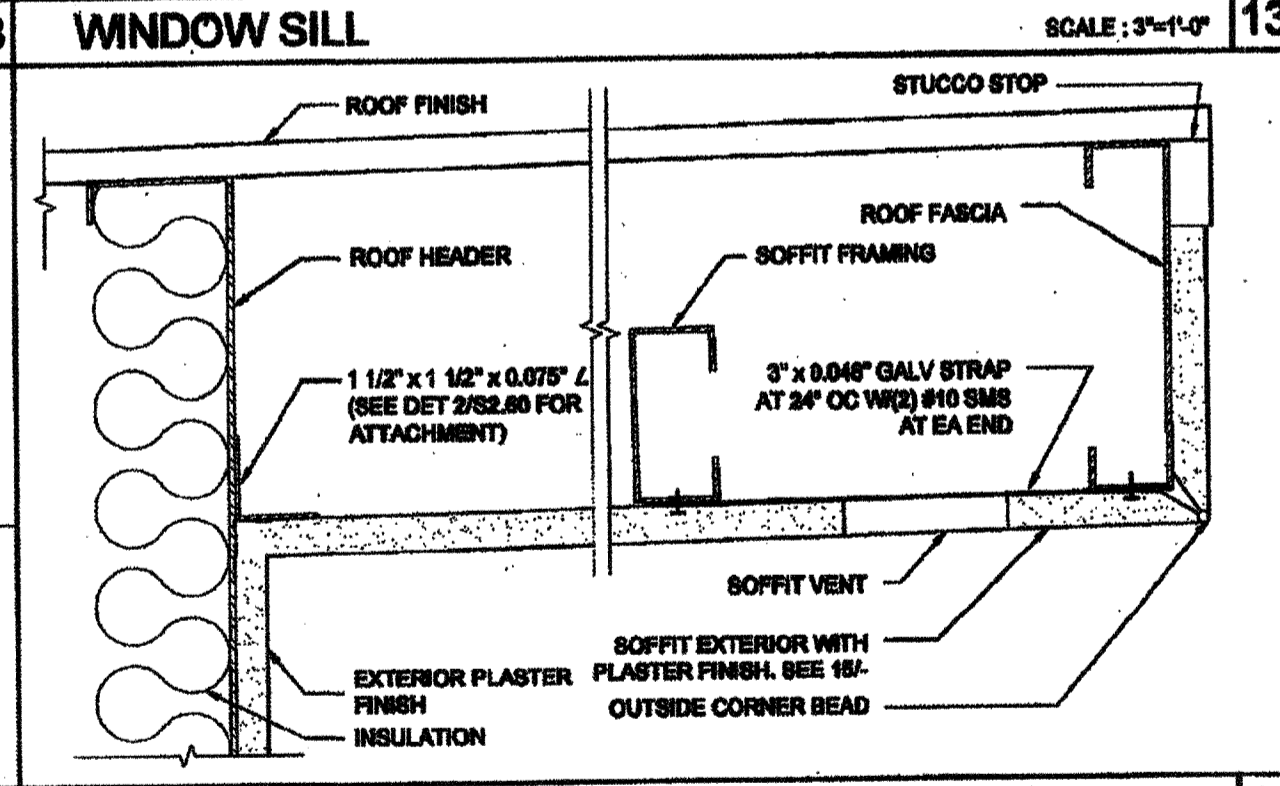

SOFFIT AT ROOF HEADER WITH VENT SCALE: 3/4"=1'-0" 14

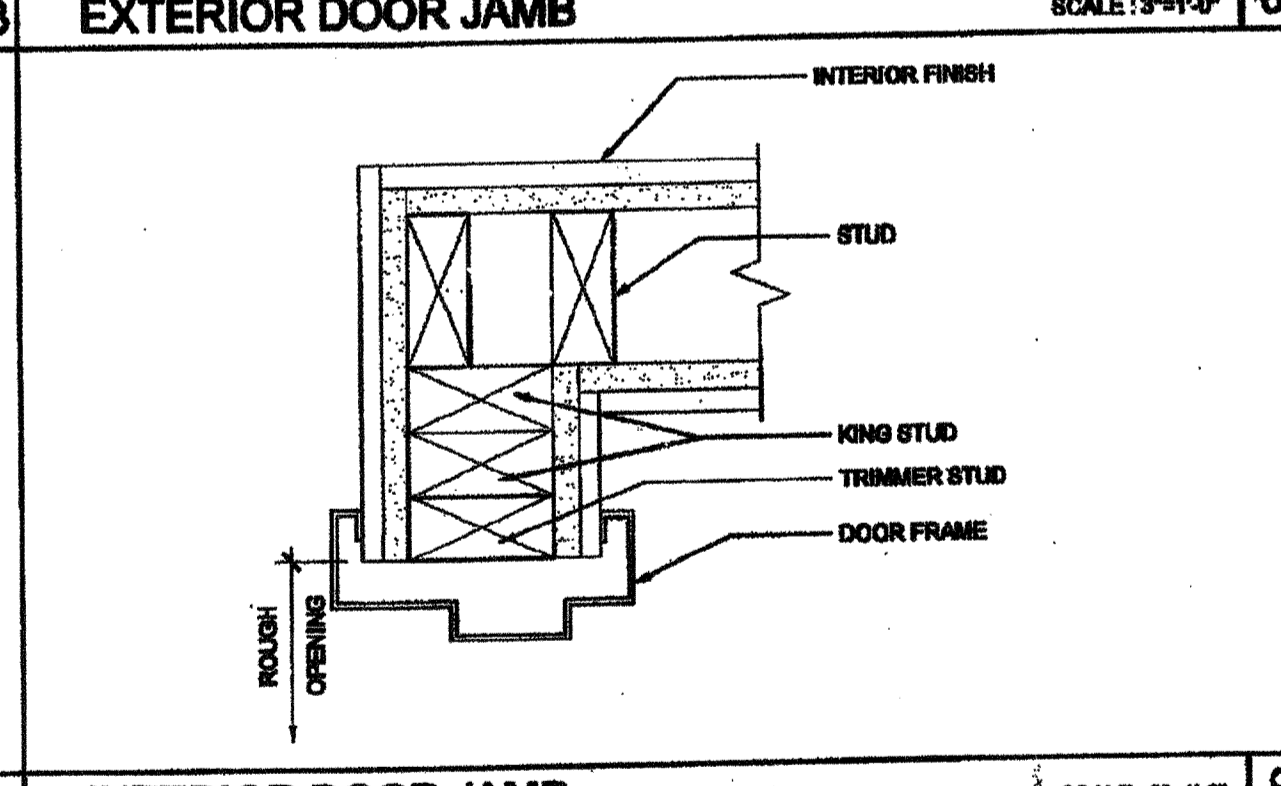

INTERIOR DOOR JAMB SCALE: 3/4"=1'-0" 9

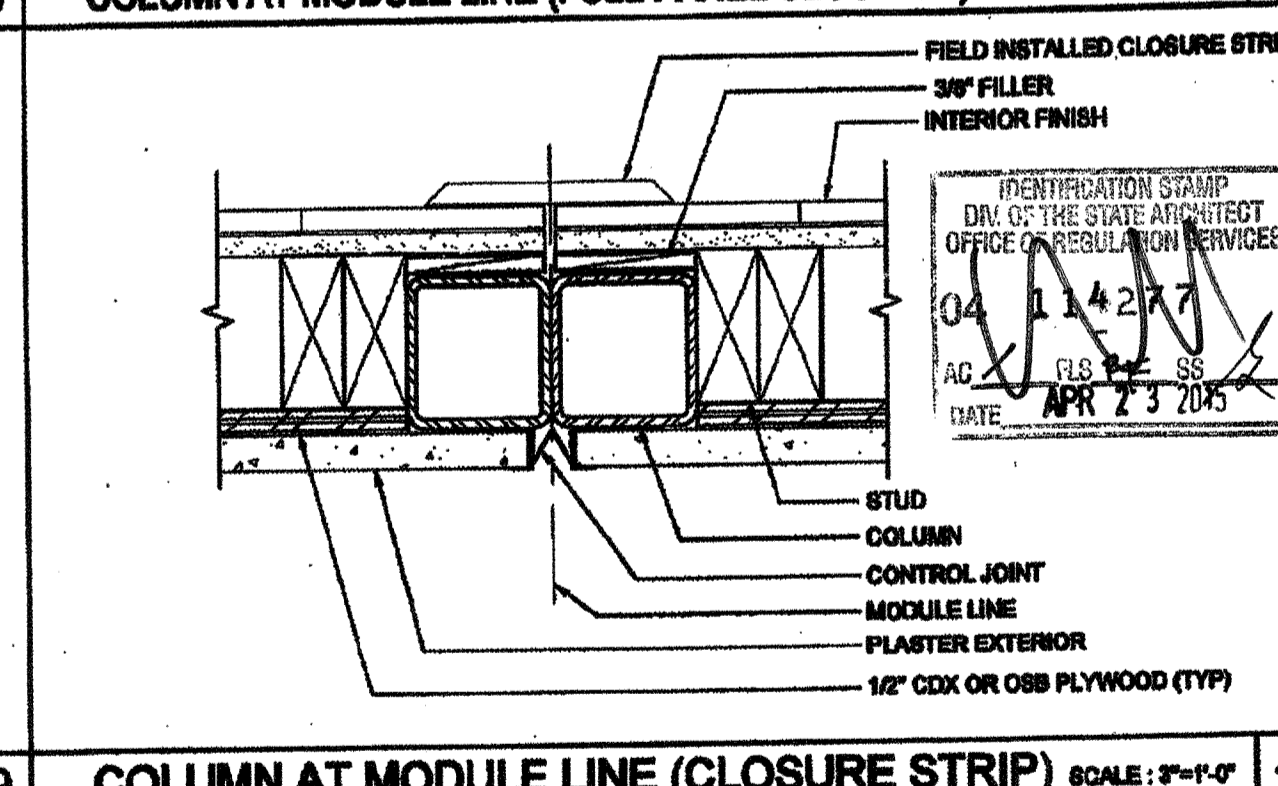

COLUMN AT MODULE LINE (CLOSURE STRIP) SCALE: 3/4"=1'-0" 4

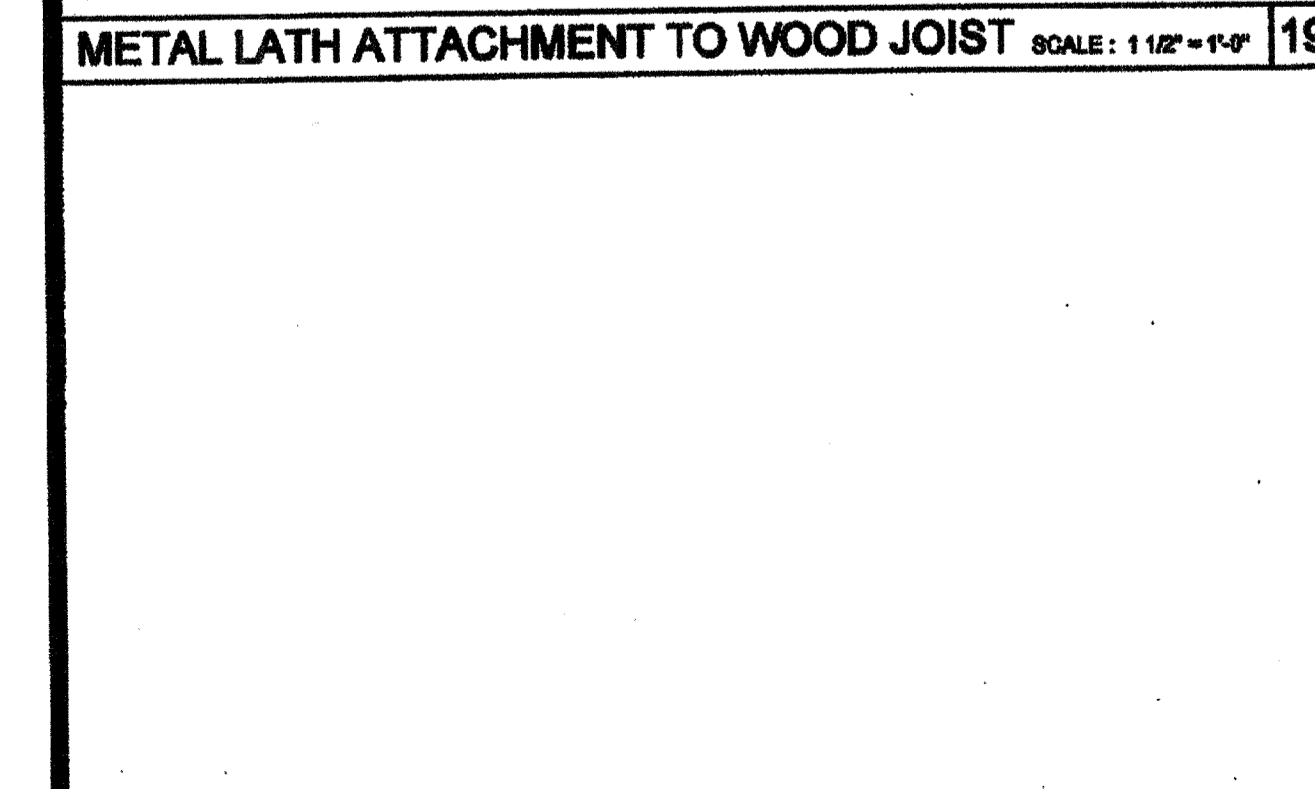

METAL LATH ATTACHMENT TO METAL JOIST SCALE: NTS 15

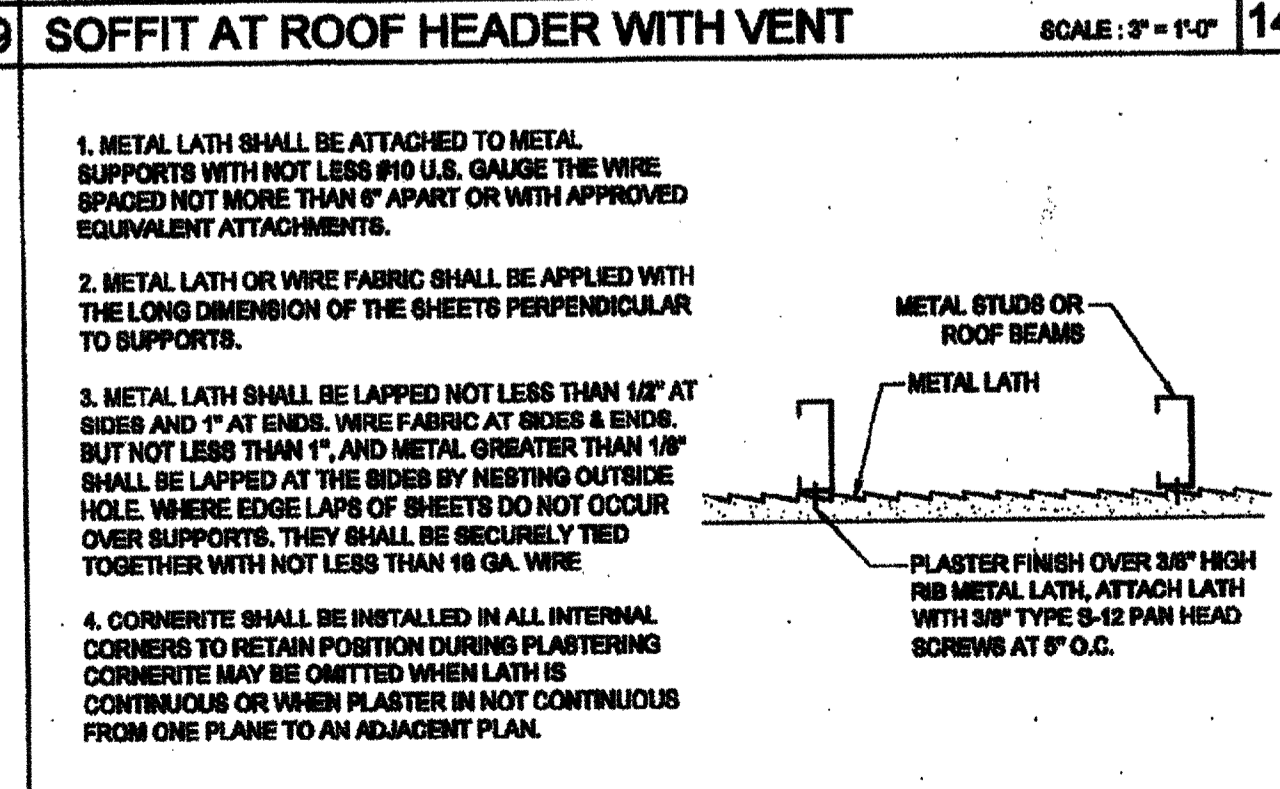

INTERIOR DOOR JAMBS SCALE: 3/4"=1'-0" 10

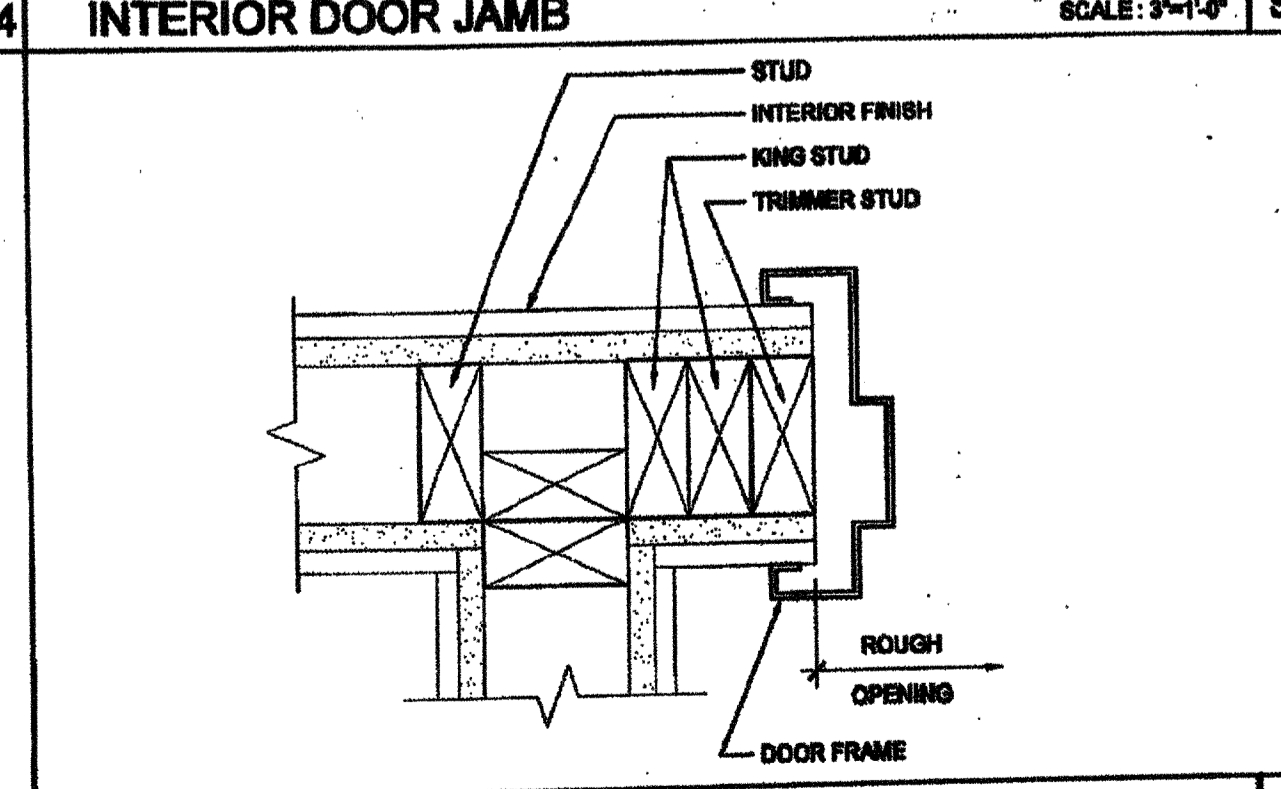

TOP PLATE AT ROOF HEADER SCALE: 3/4"=1'-0" 5

NOT USED 20