

THESE DRAWINGS AND/OR SPECIFICATIONS ARE FOR INFORMATION ONLY. THE CONTRACTOR SHALL BE RESPONSIBLE FOR OBTAINING ALL NECESSARY PERMITS AND APPROVALS FROM THE LOCAL, STATE AND FEDERAL AUTHORITIES. THE CONTRACTOR SHALL BE RESPONSIBLE FOR OBTAINING ALL NECESSARY PERMITS AND APPROVALS FROM THE LOCAL, STATE AND FEDERAL AUTHORITIES. THE CONTRACTOR SHALL BE RESPONSIBLE FOR OBTAINING ALL NECESSARY PERMITS AND APPROVALS FROM THE LOCAL, STATE AND FEDERAL AUTHORITIES.

REGISTERED PROFESSIONAL ARCHITECT
 DATE: APR 13 2000
 APPLICATION NO: OC-101714

12 x 40
 RESTROOM



American Modular Systems
 REGISTERED PROFESSIONAL ENGINEER
 License No. 41812
 State of California
 Date: 12/15/99

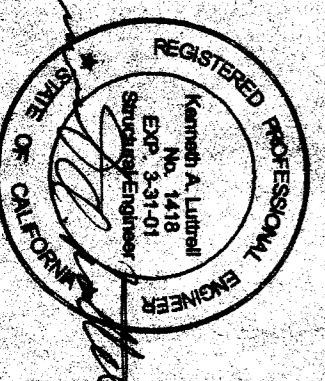

American Modular Systems
 REGISTERED PROFESSIONAL ENGINEER
 License No. 41812
 State of California
 Date: 12/15/99

CUSTOMER:
 FRAMING ELEVATIONS
 AND DETAILS

NO.	DATE	DESCRIPTION	NO.	DATE	DESCRIPTION

PROJECT NO. 99175
 SHEET NO. S4

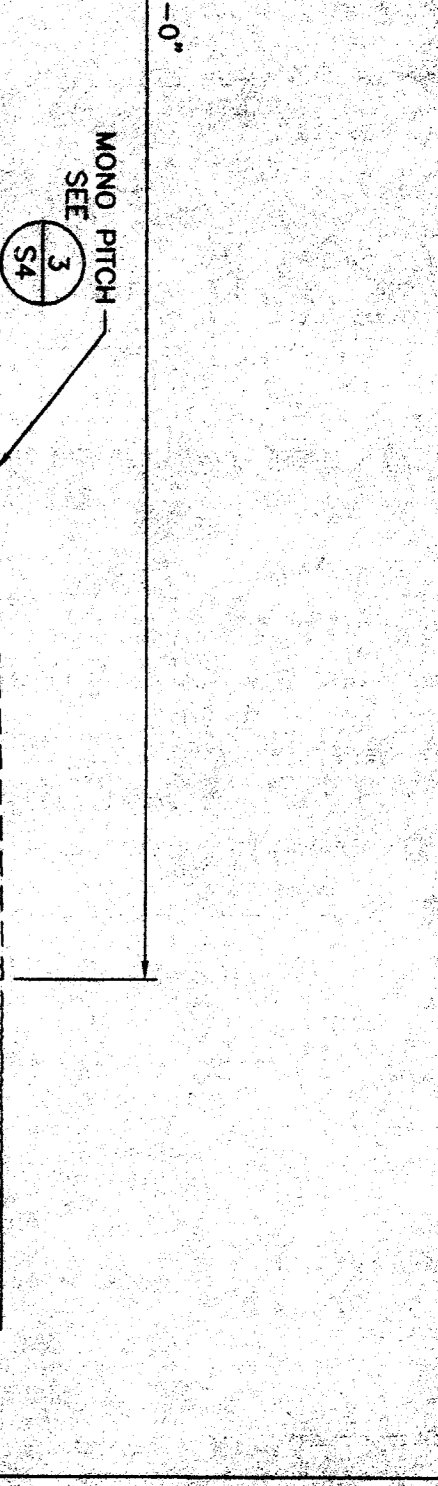
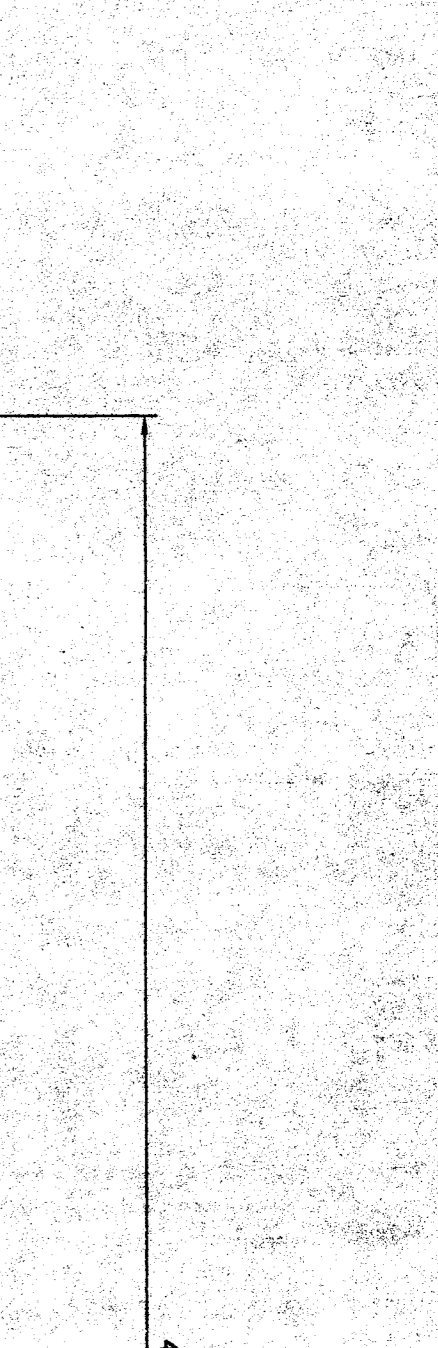
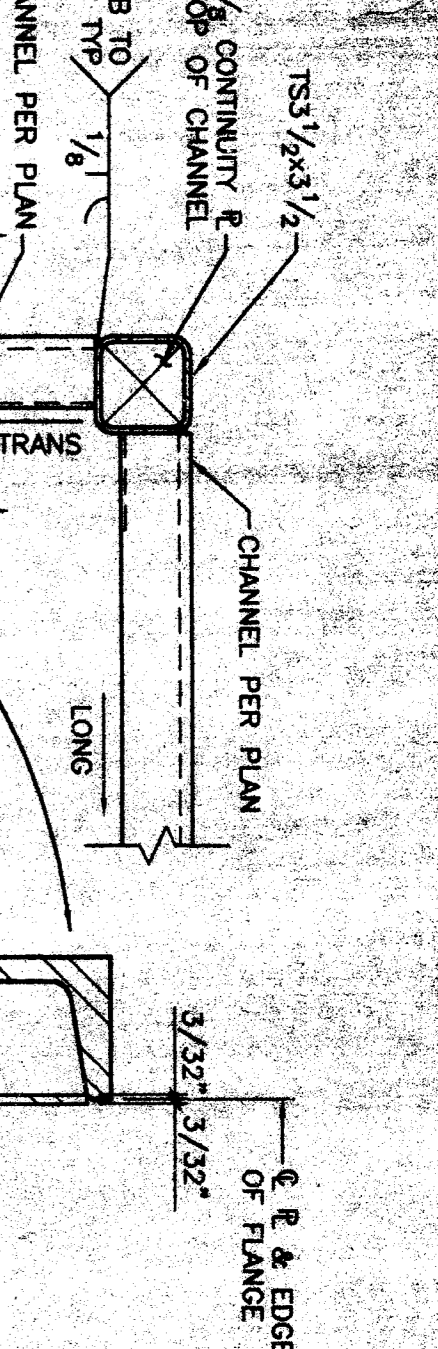
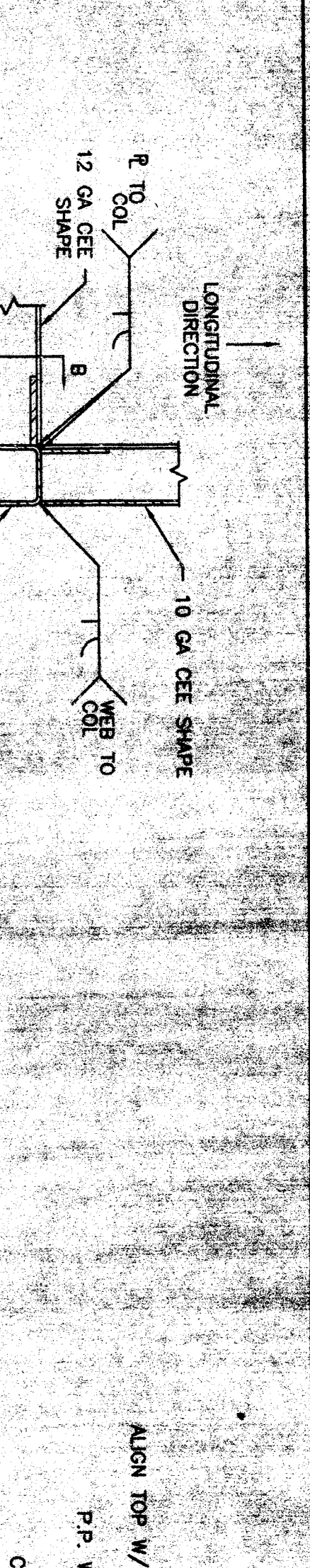
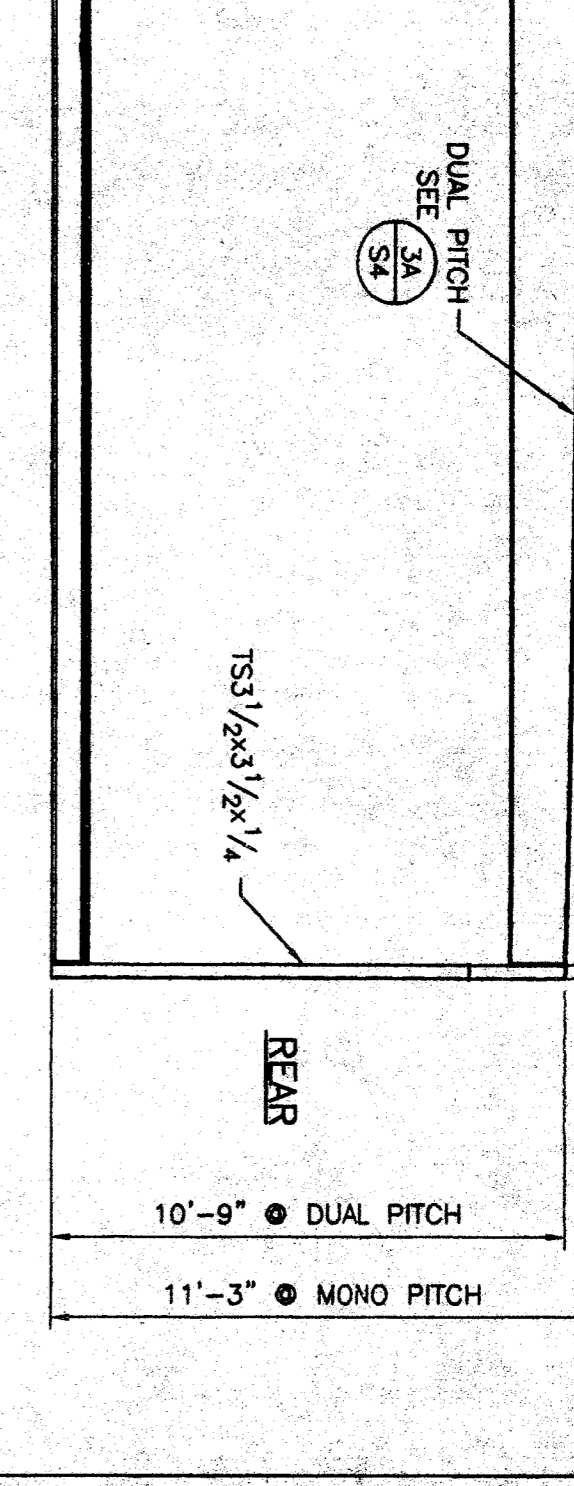
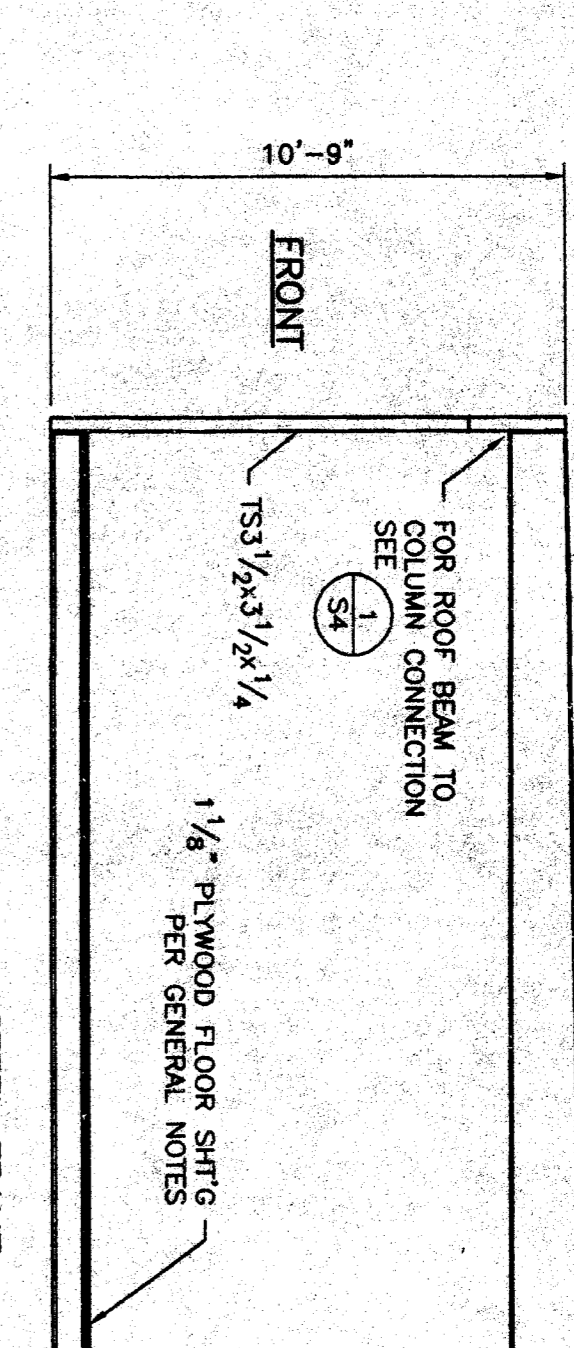
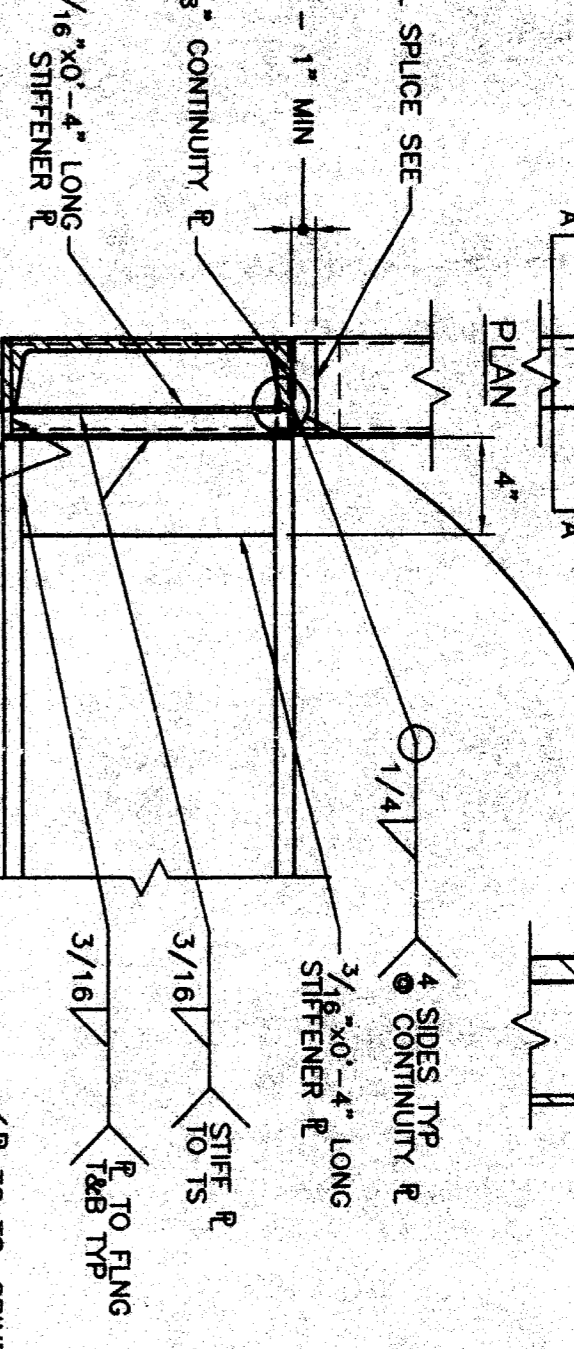
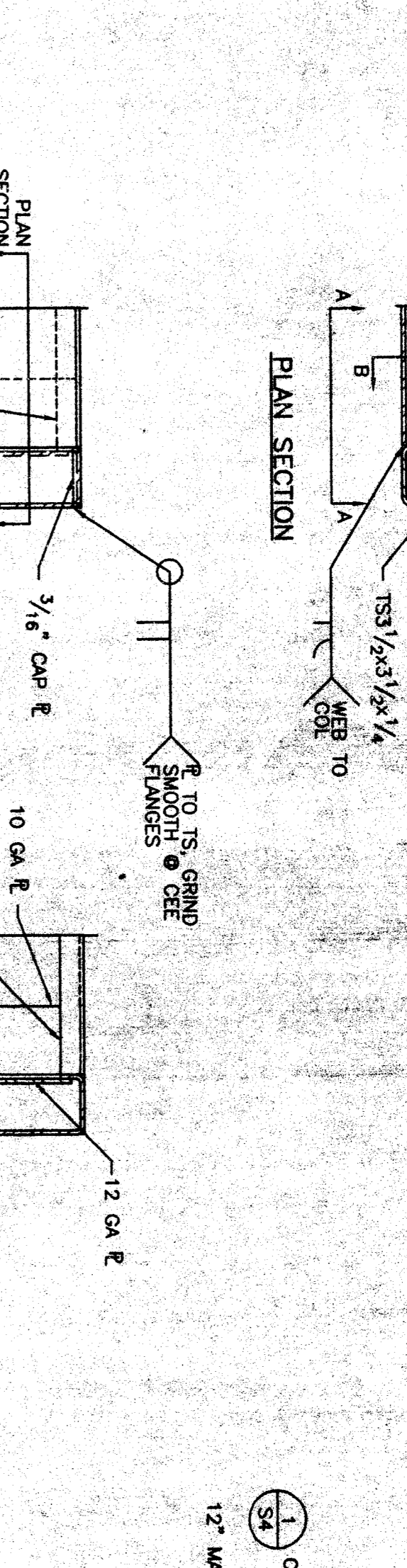
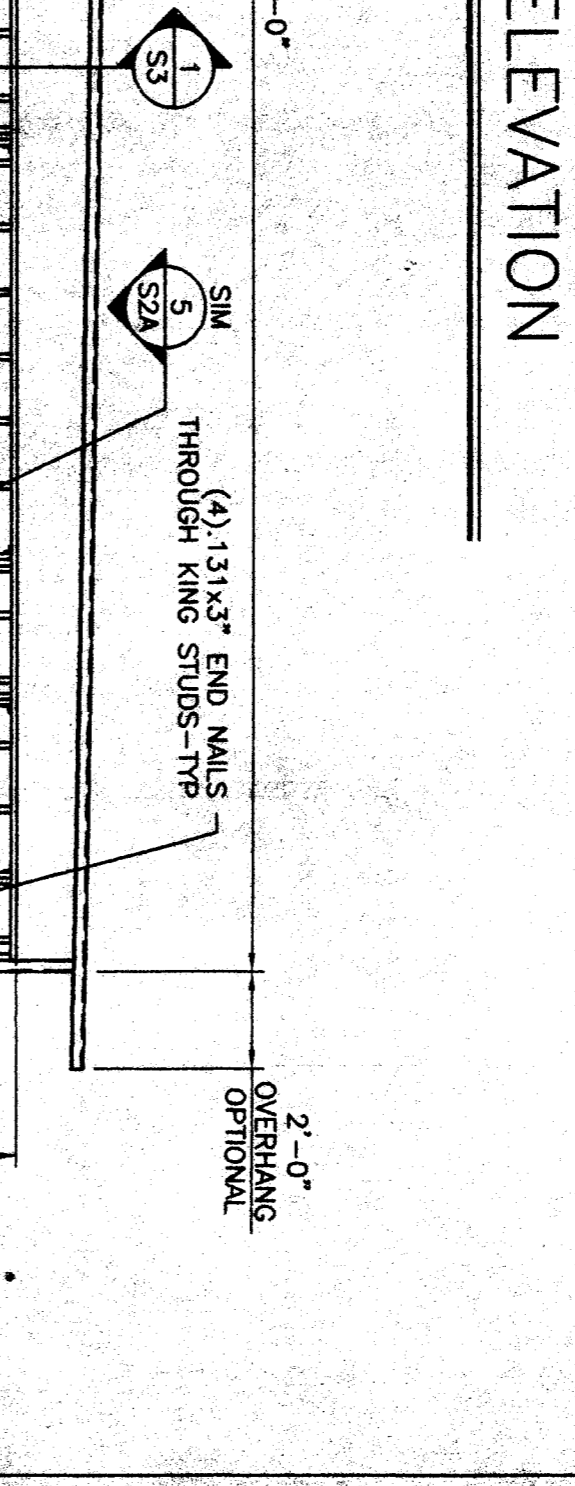
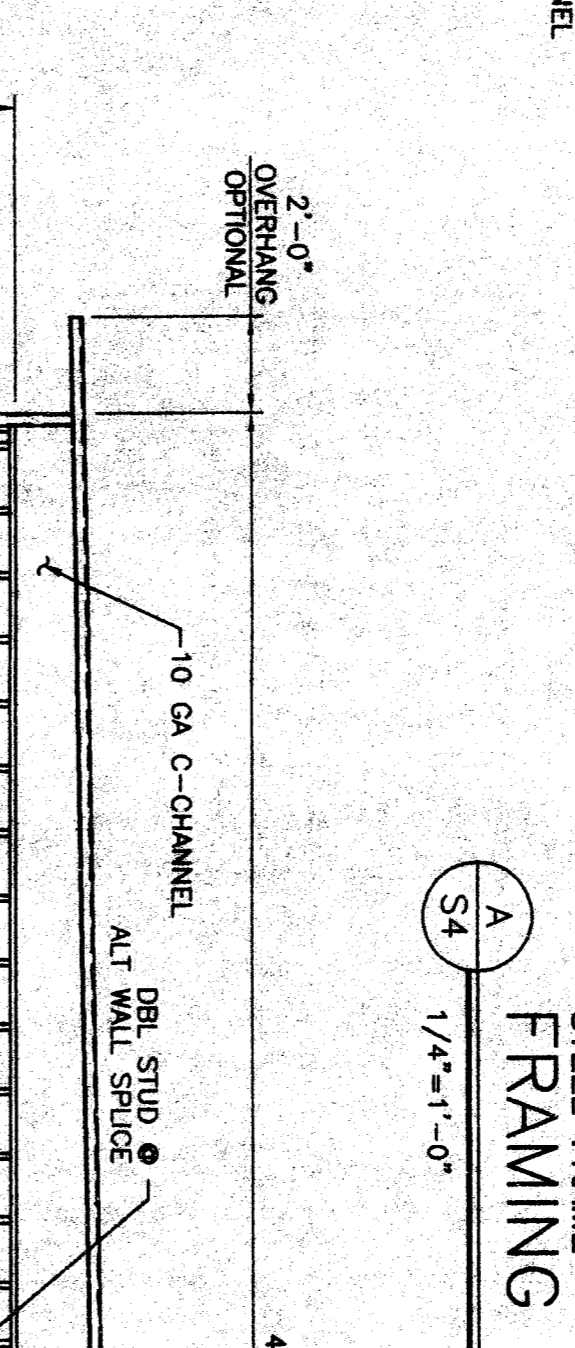
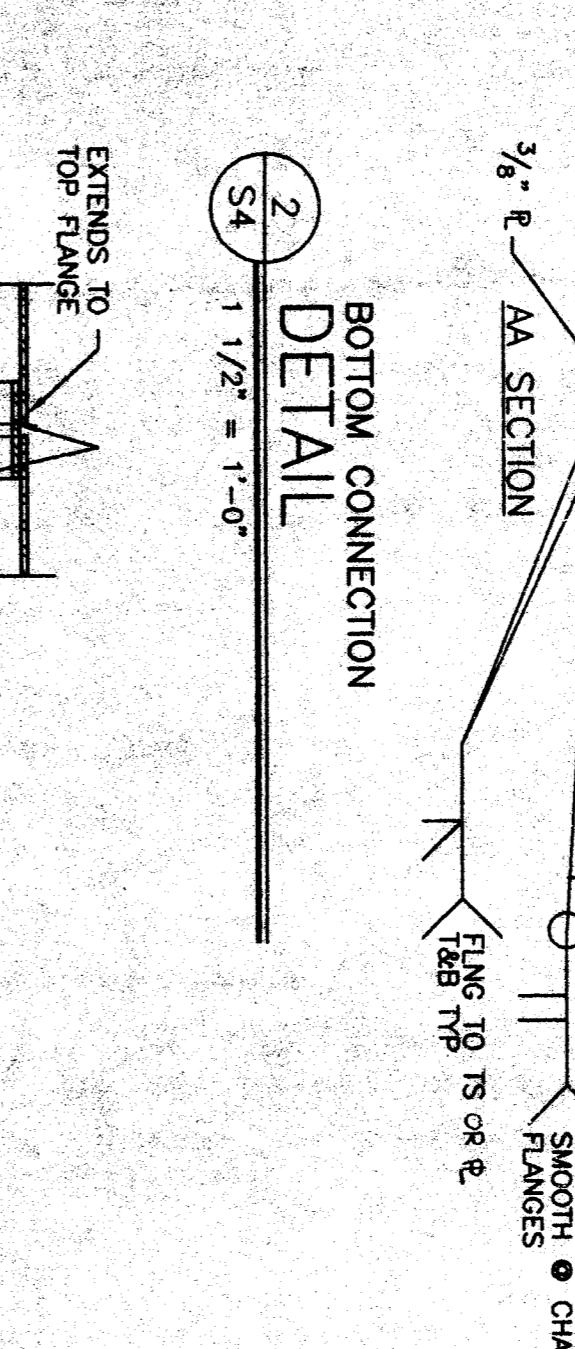
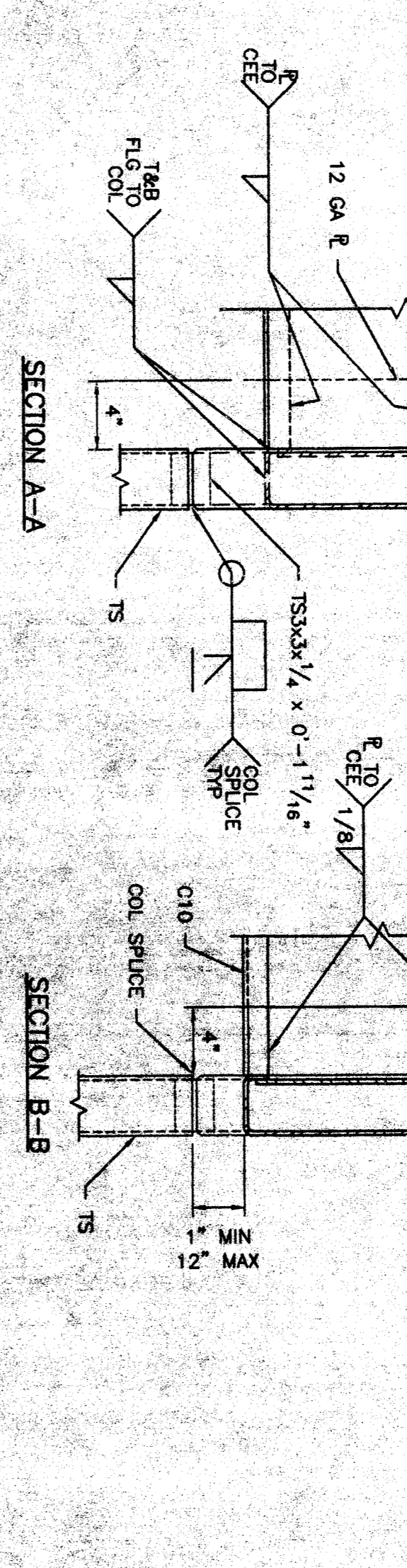
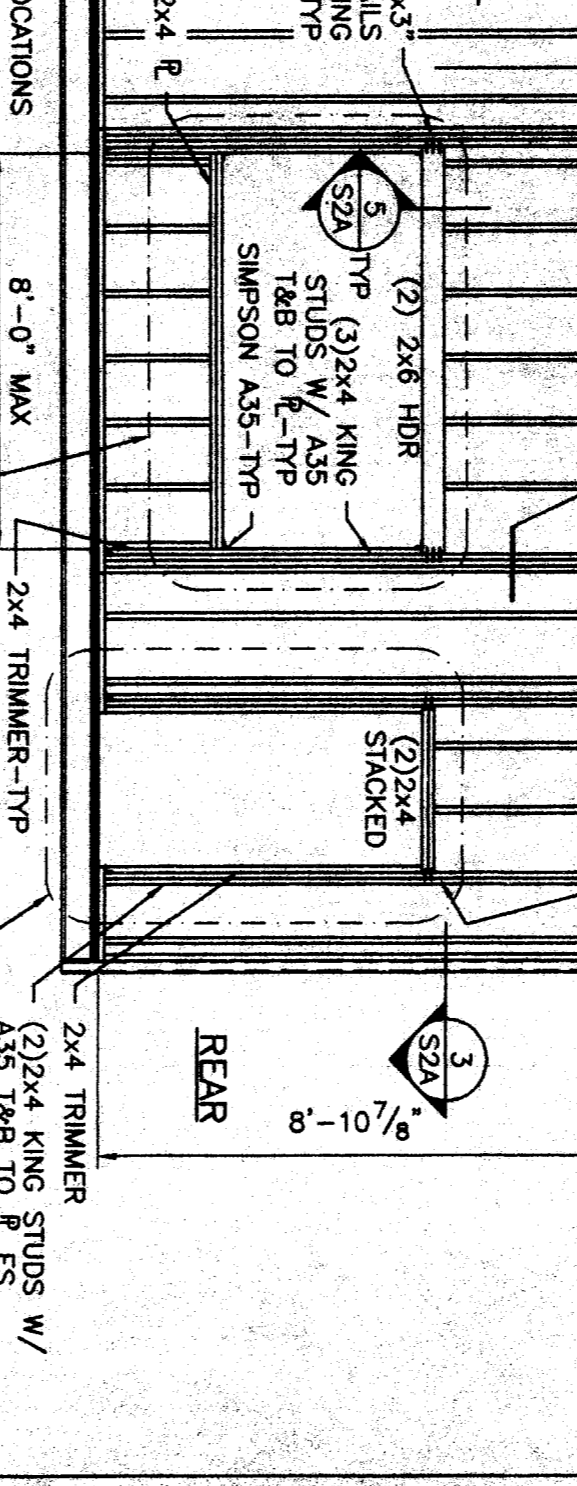
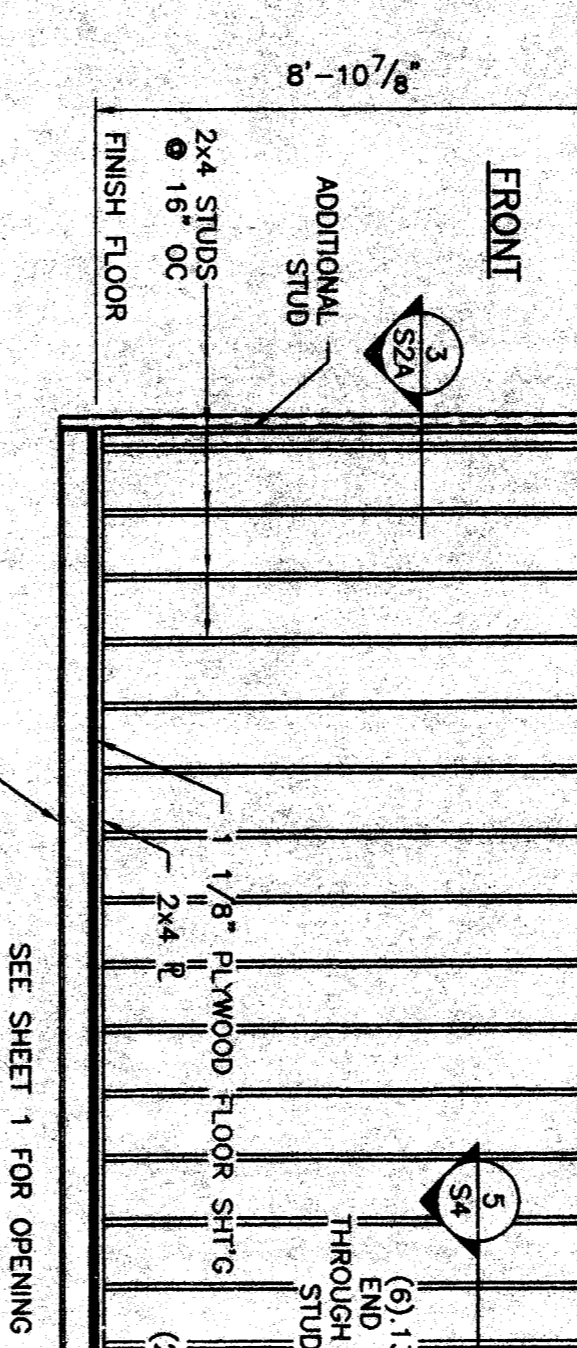
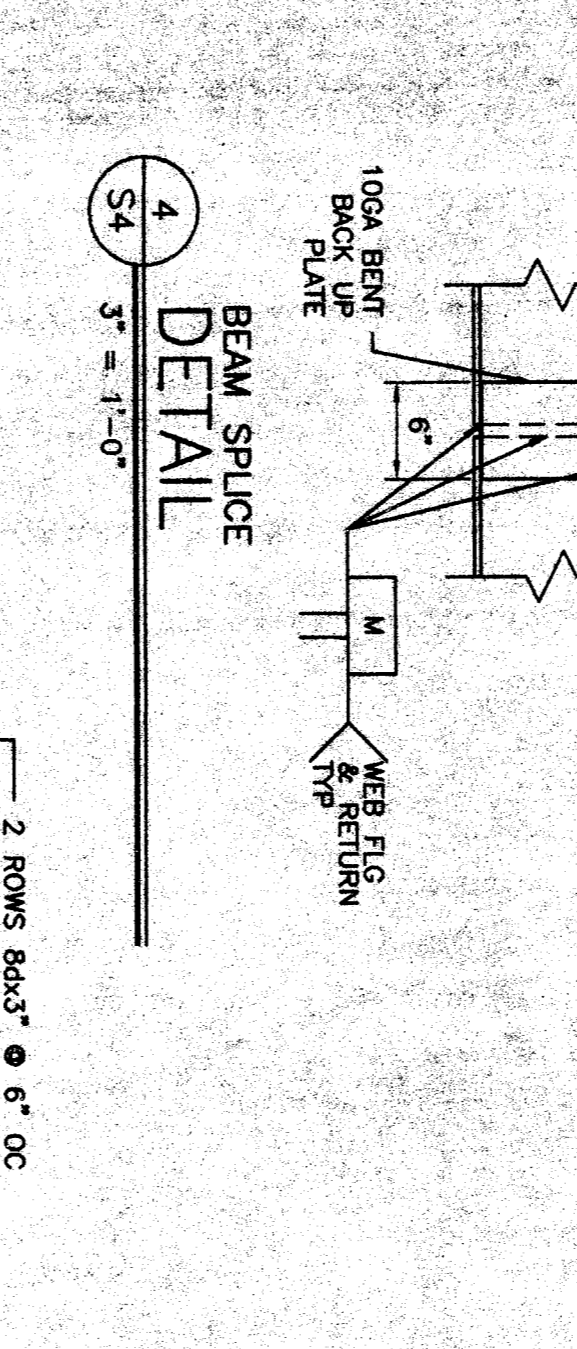
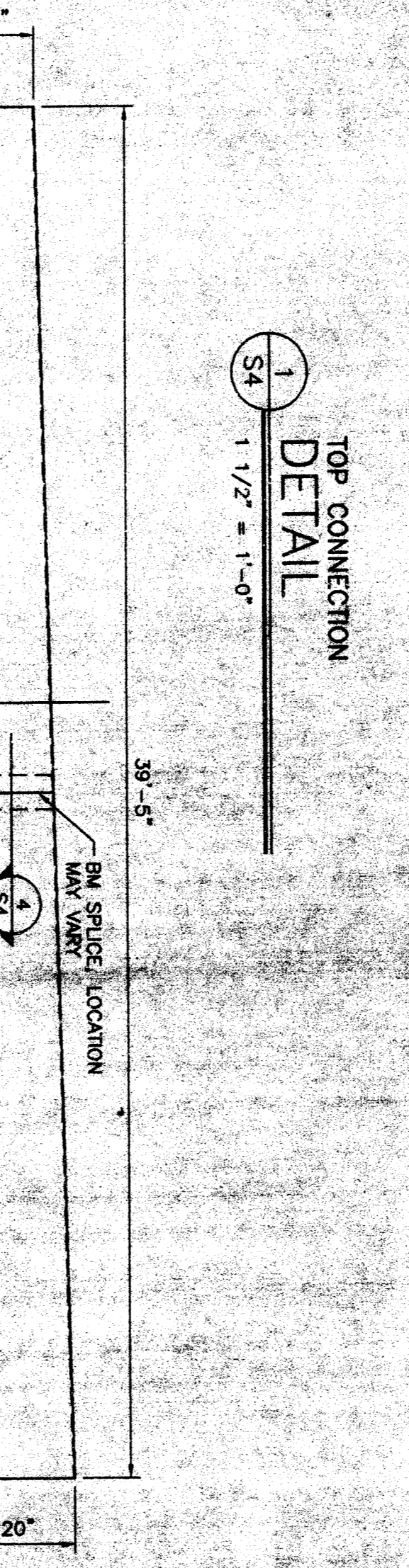
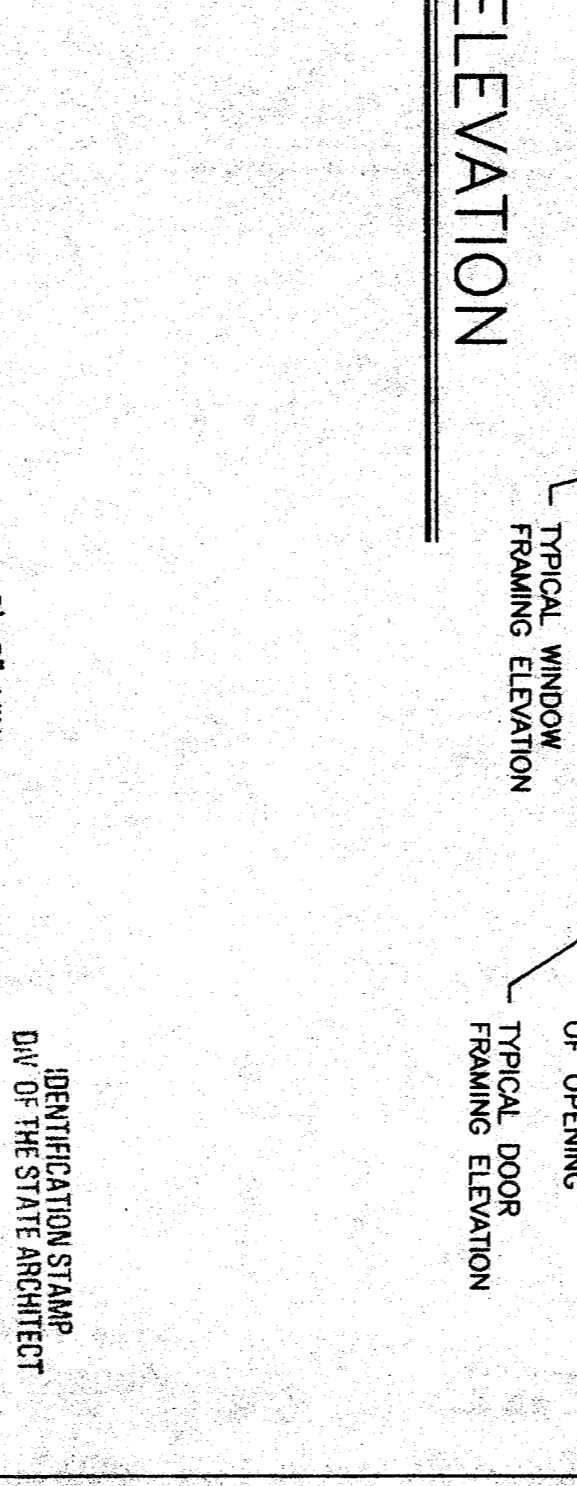
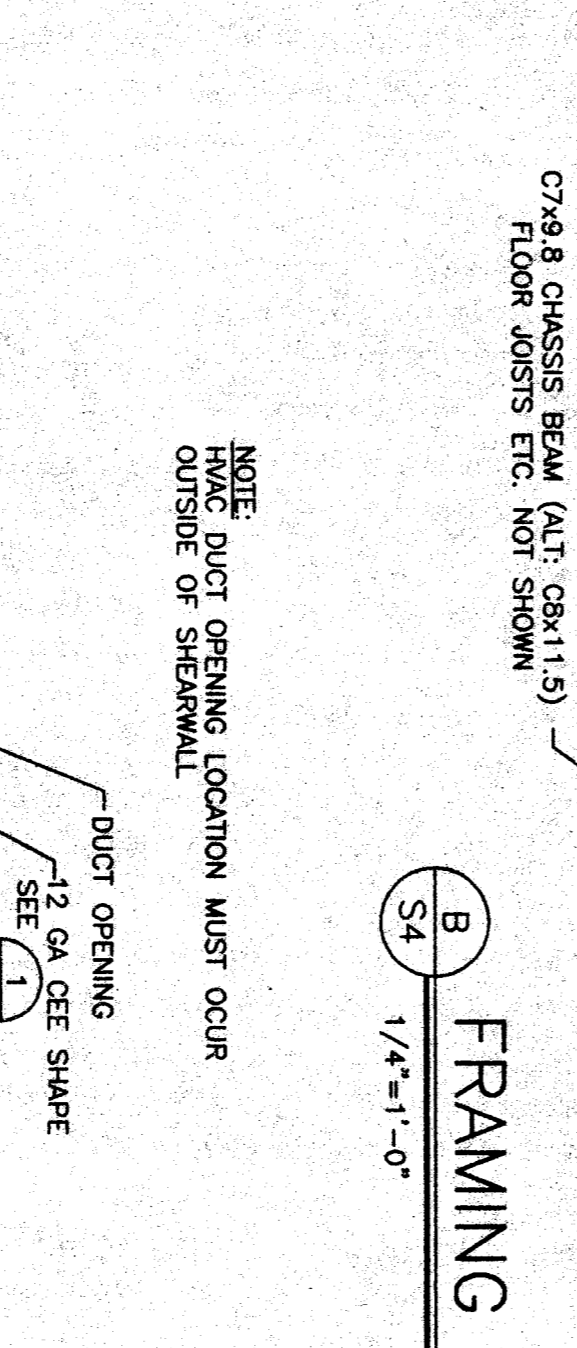
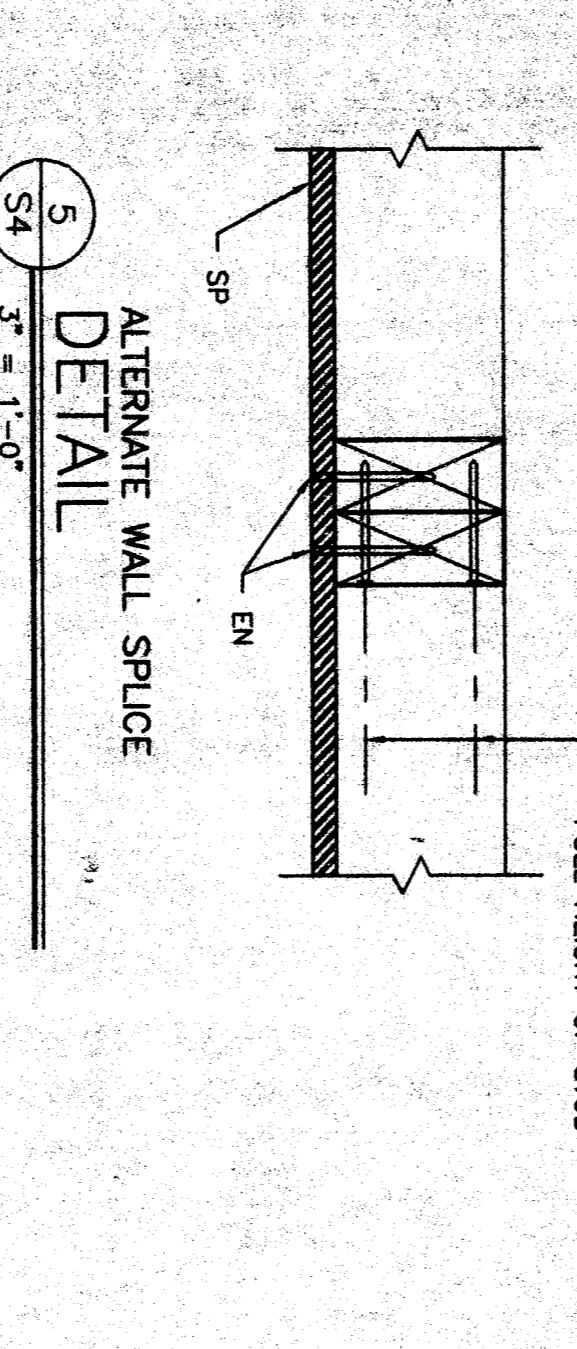
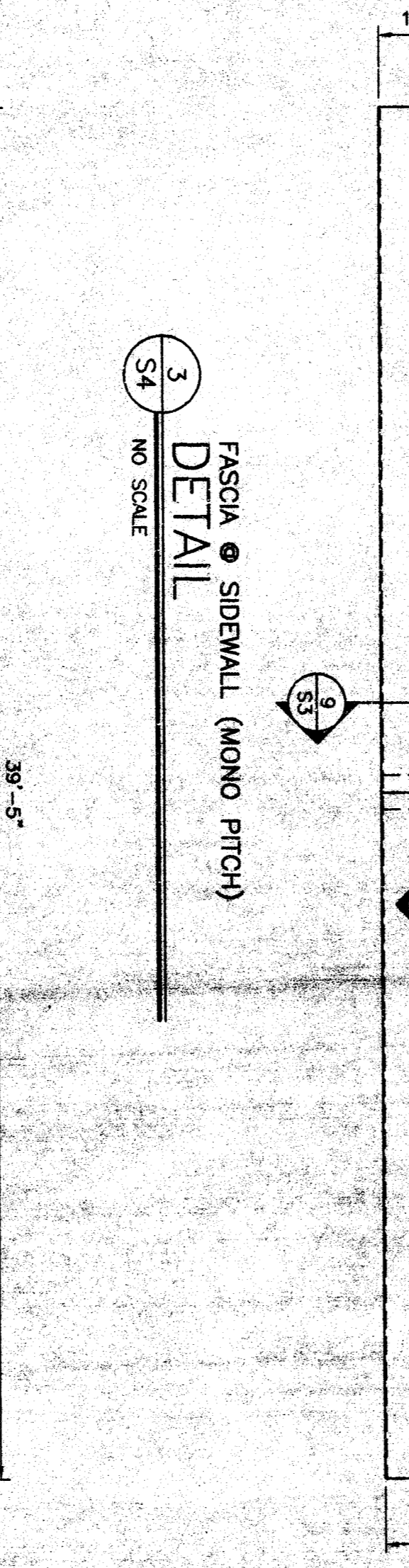
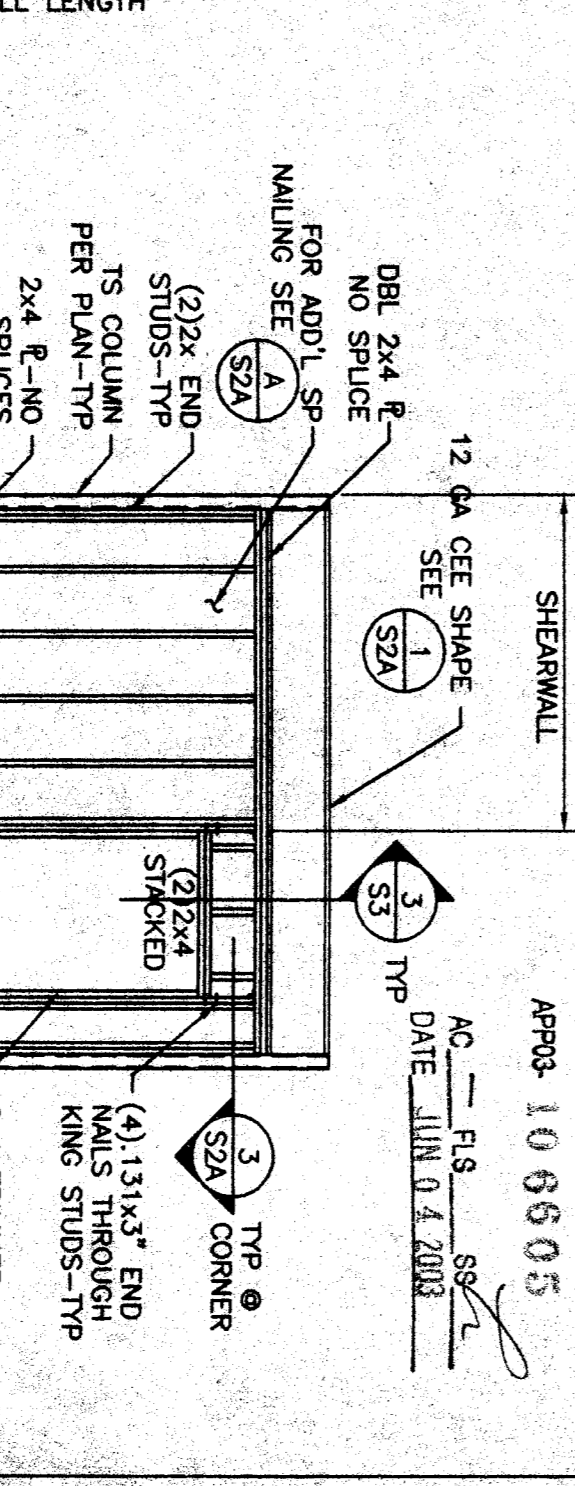
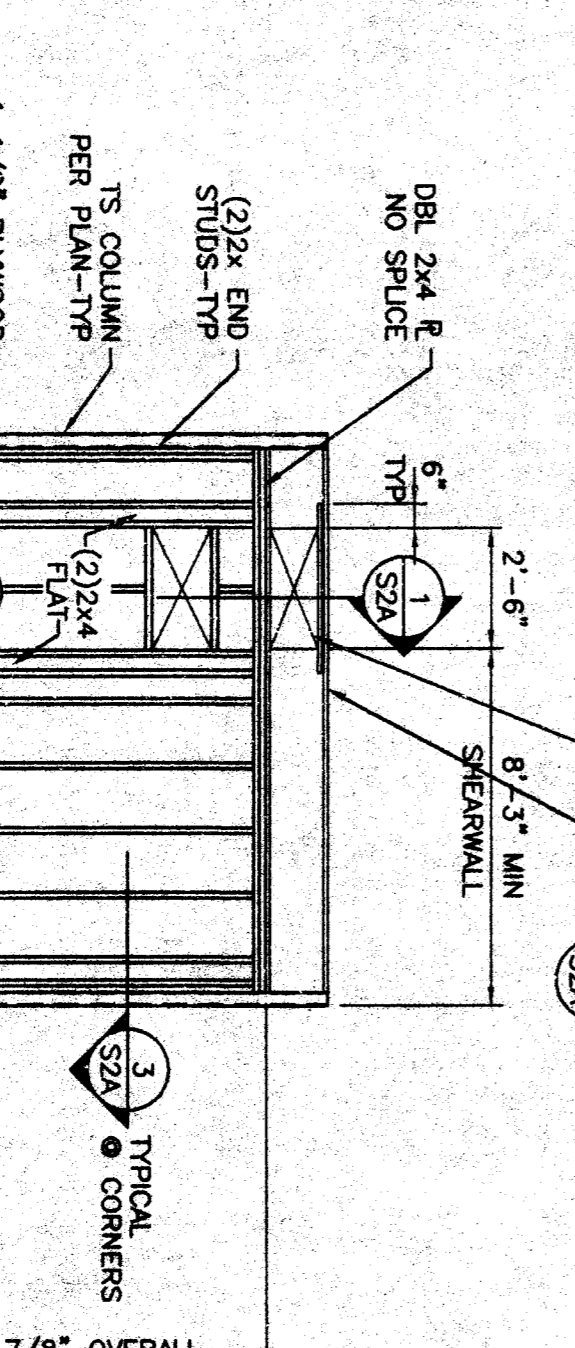
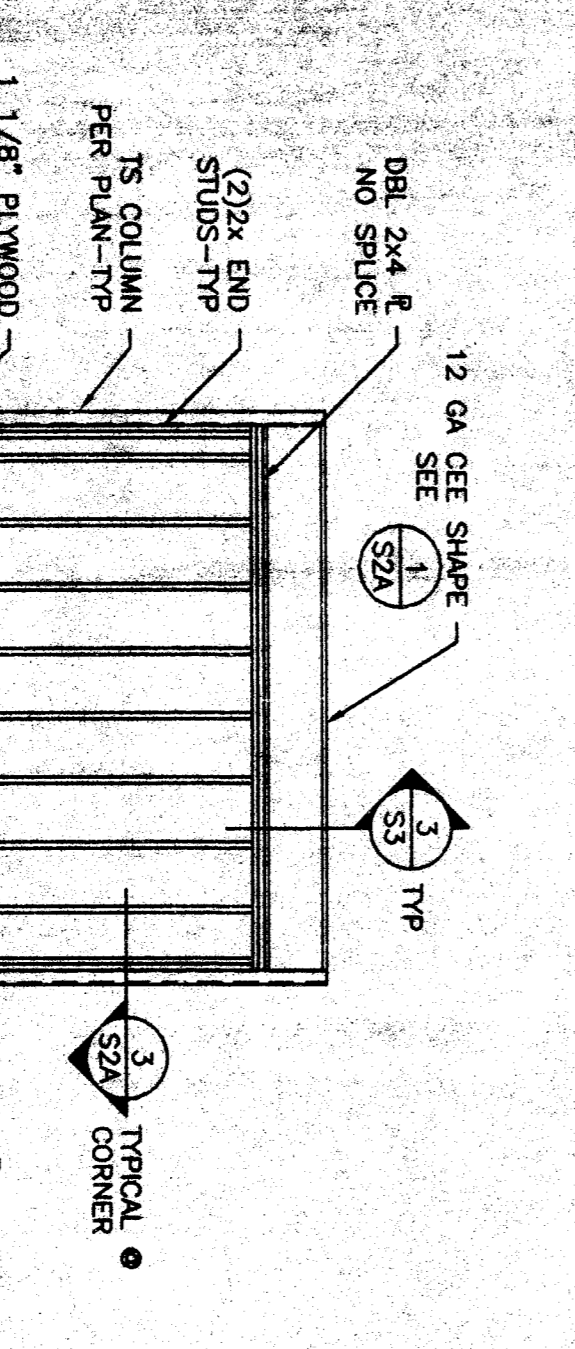
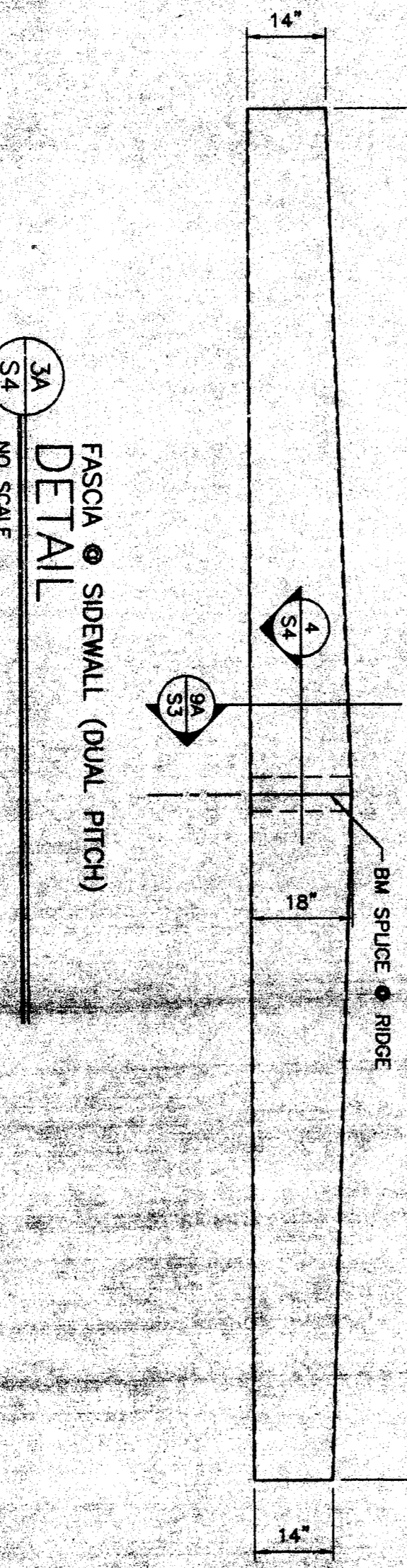
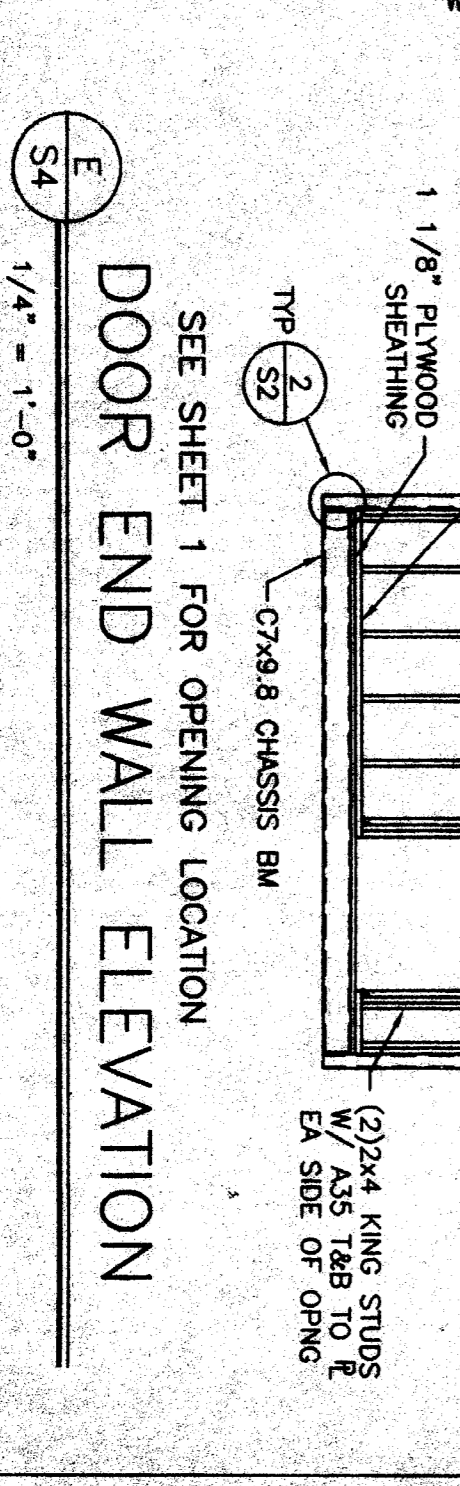
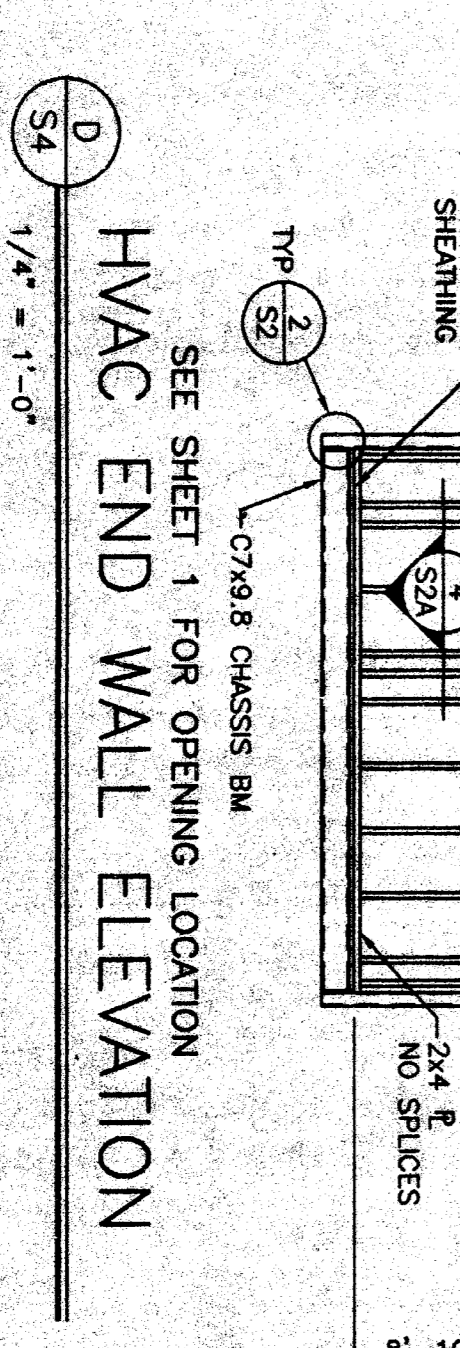
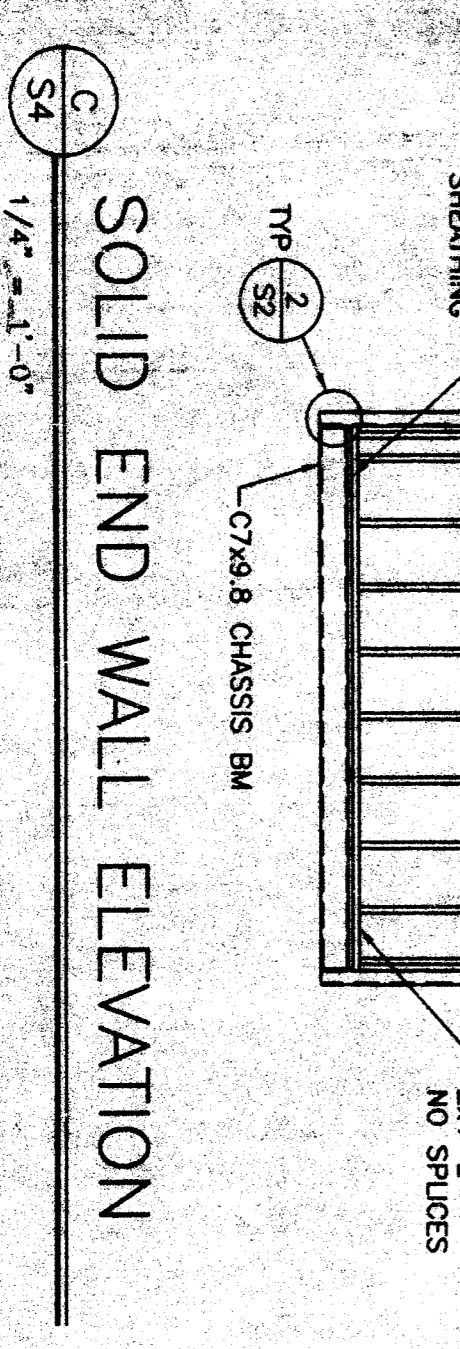
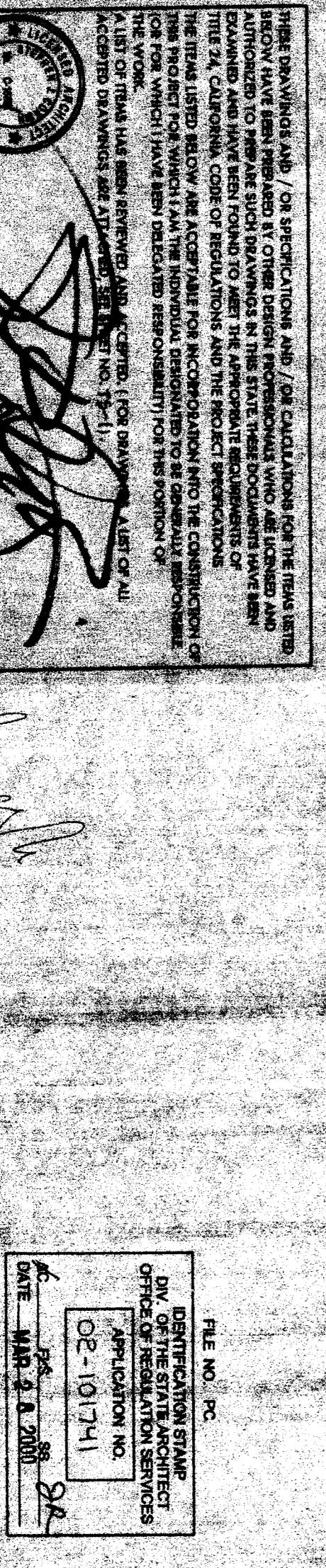

IDENTIFICATION STAMP
 DIV. OF THE STATE ARCHITECT
 APPROX 106605
 DATE: JUN 04 2003