

1 ROOF MOD TRIM
SCALE: 1/2"=1'-0"

6 ROOF RAKE
SCALE: 1/2"=1'-0"

11 MODULE LINE ROOF CAP
SCALE: 1/2"=1'-0"

19 INT. DOOR HEAD
SCALE: 1/2"=1'-0"

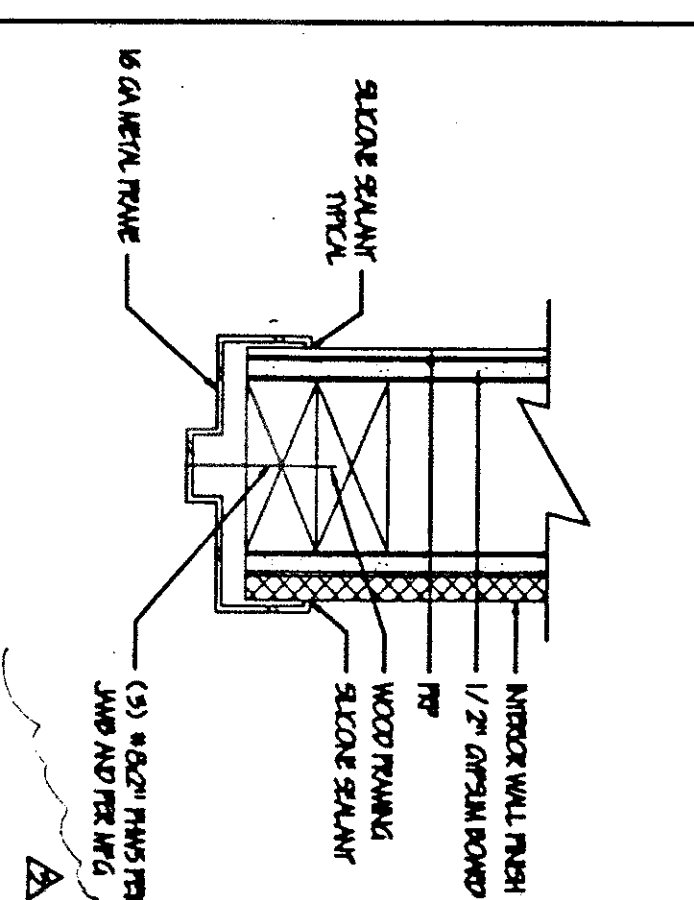
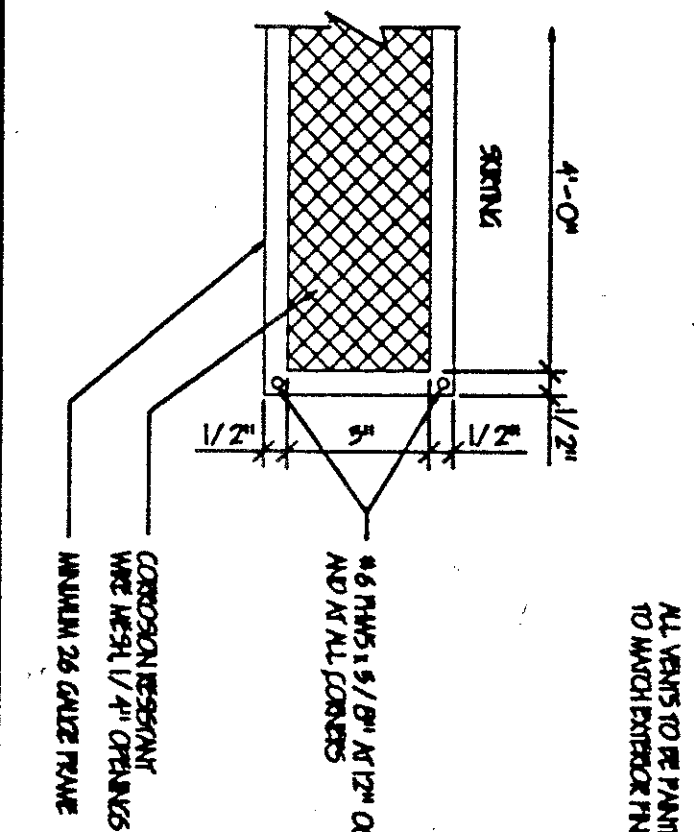
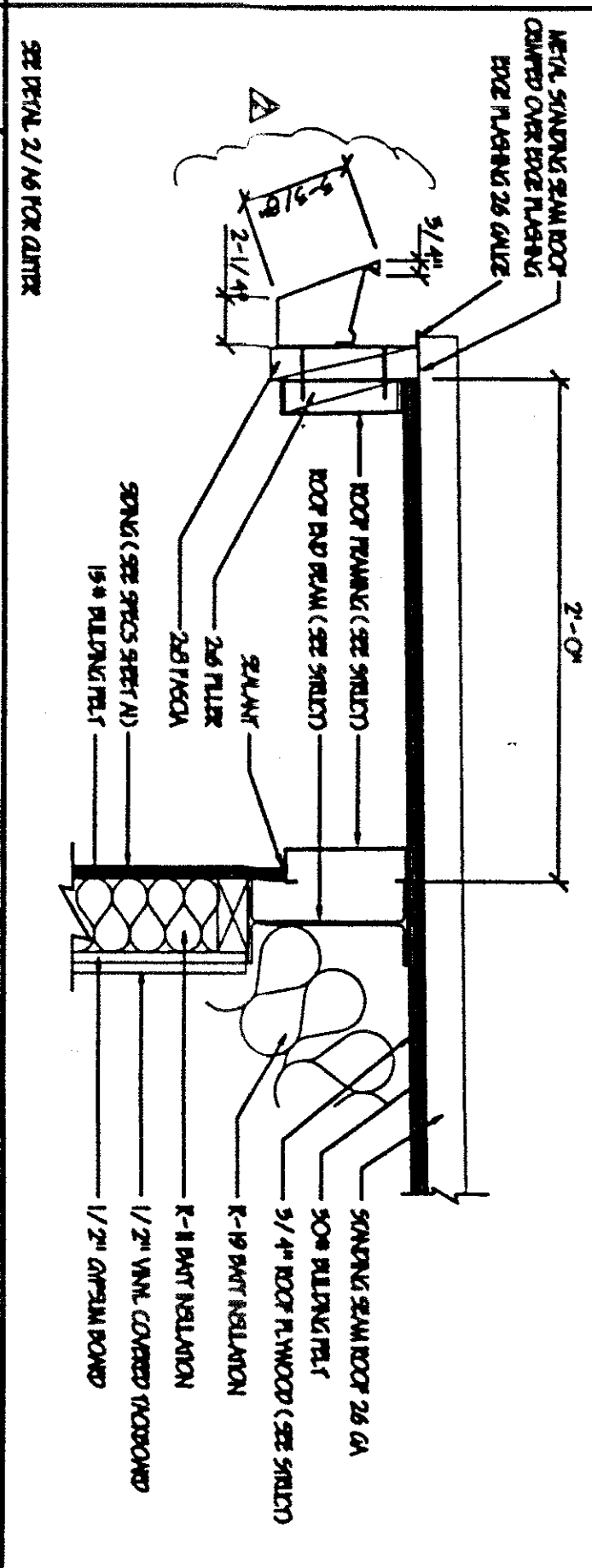
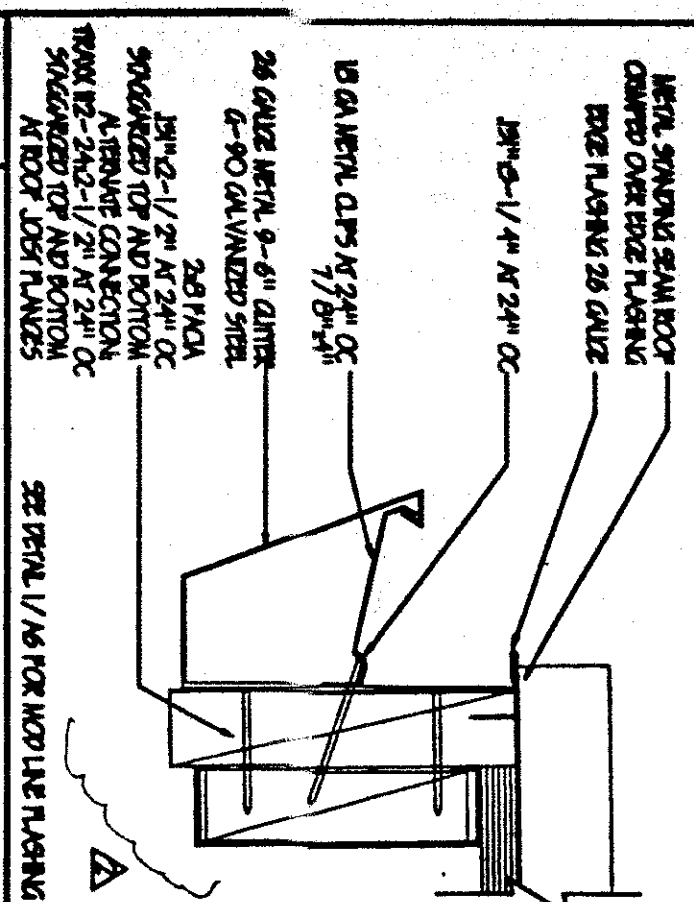

2 GUTTER
SCALE: 1/2"=1'-0"

7 REAR OVRHG
SCALE: 1/2"=1'-0"

15 VENT
SCALE: 1/2"=1'-0"

20 INT. DOOR JAMB
SCALE: 1/2"=1'-0"

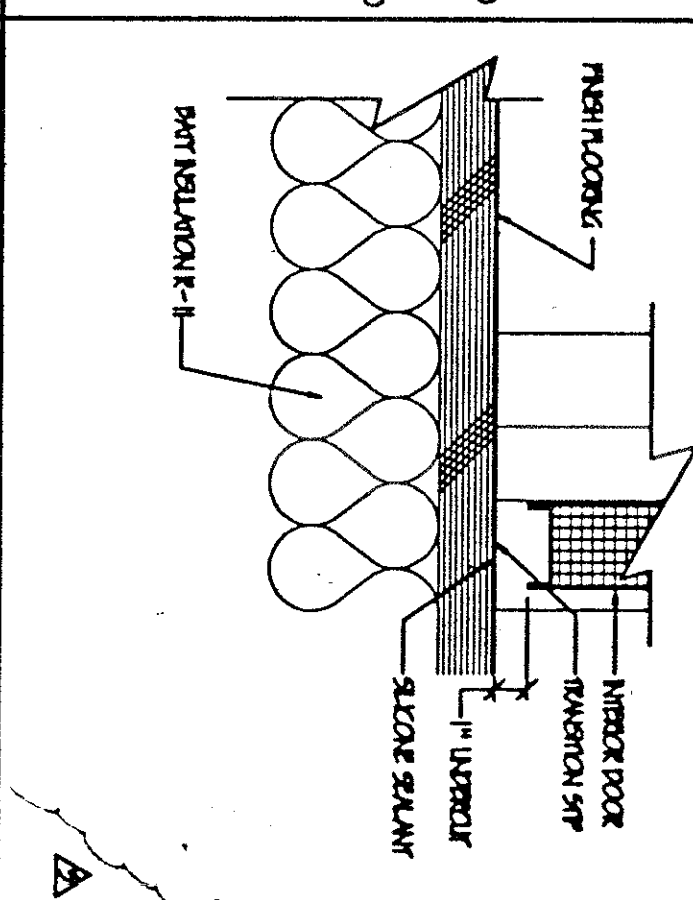
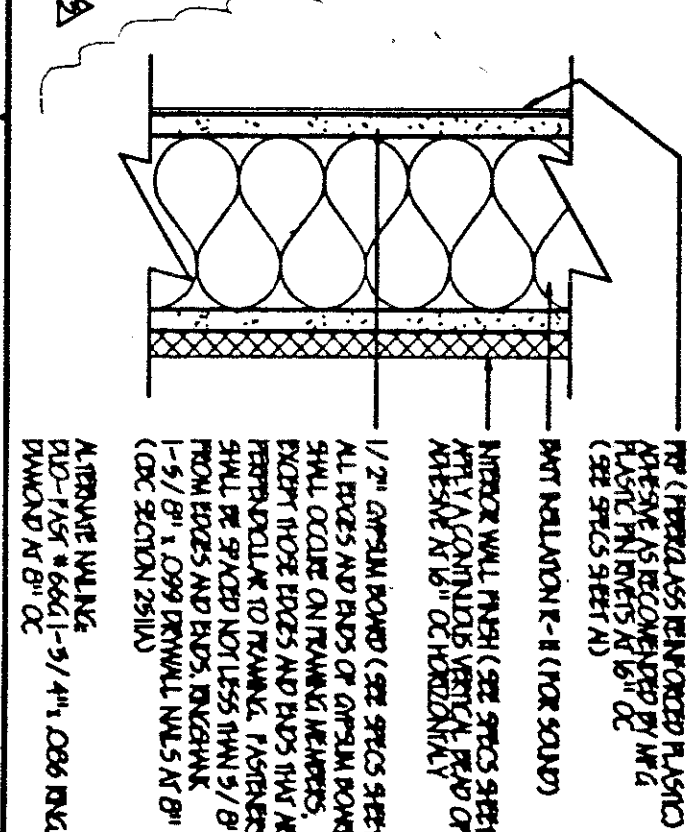
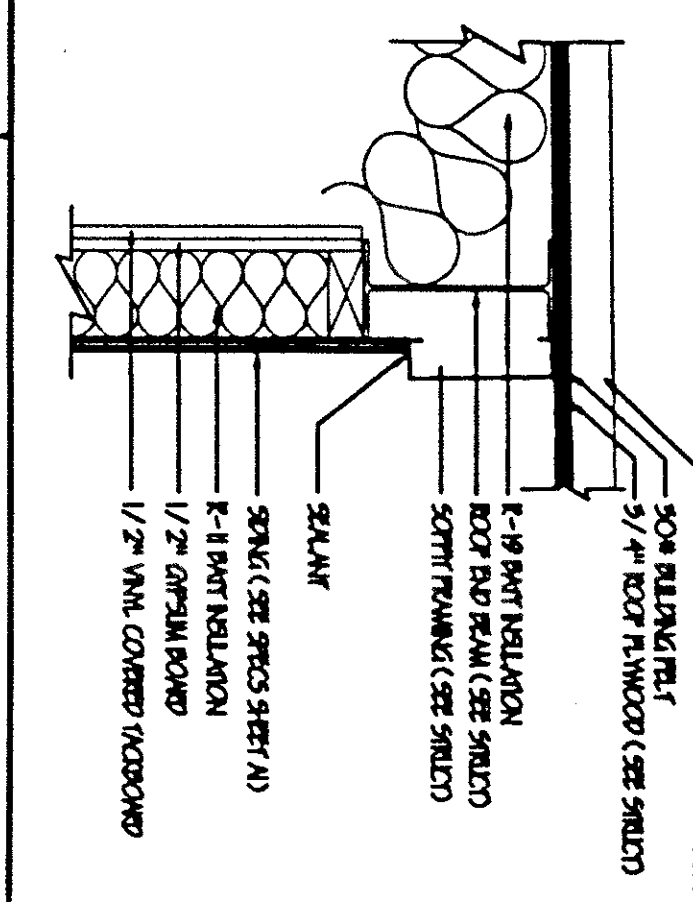
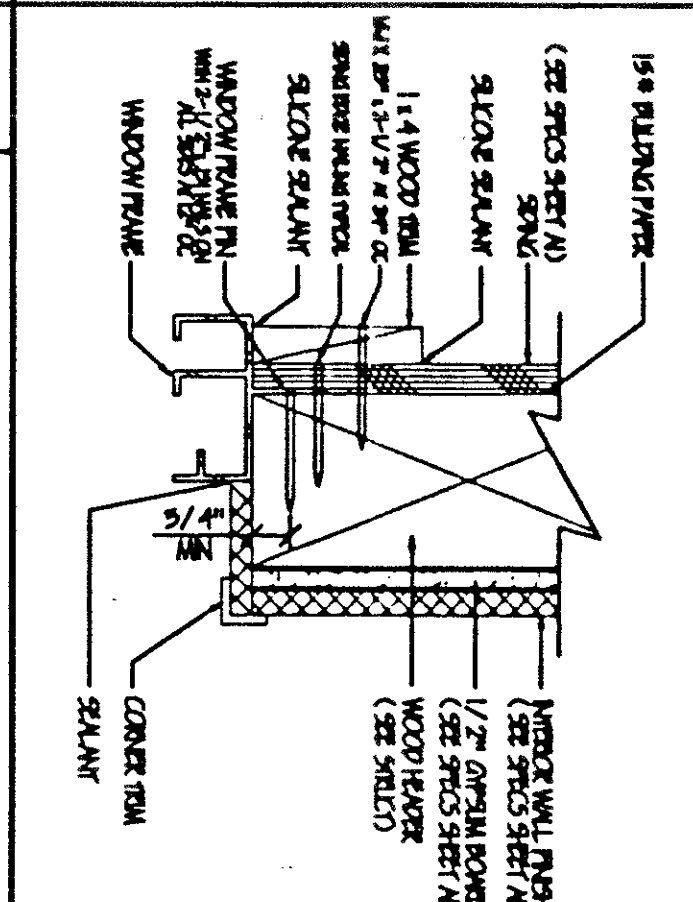
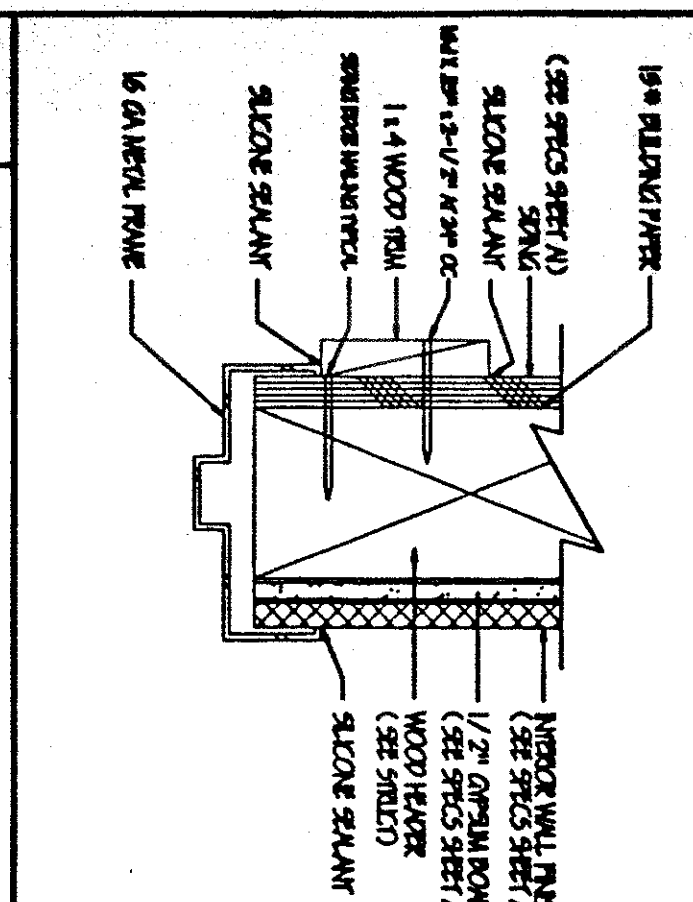

3 DOOR HEAD
SCALE: 1/2"=1'-0"

8 WINDOW HEAD
SCALE: 1/2"=1'-0"

12 ENTRY OVRHG
SCALE: 1/2"=1'-0"

16 INT. WALL FINISH
SCALE: 1/2"=1'-0"

21 DOOR THRESHOLD
SCALE: 1/2"=1'-0"

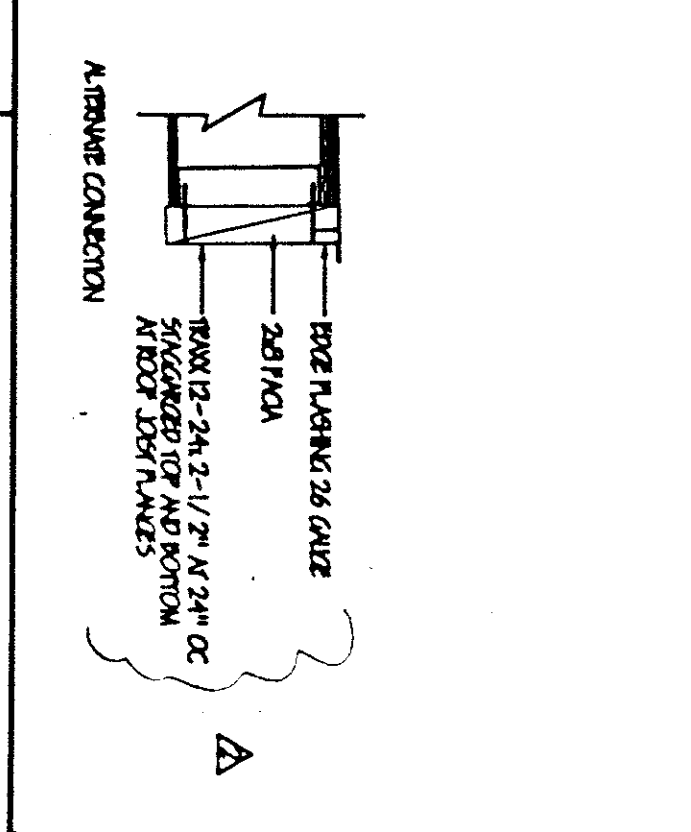
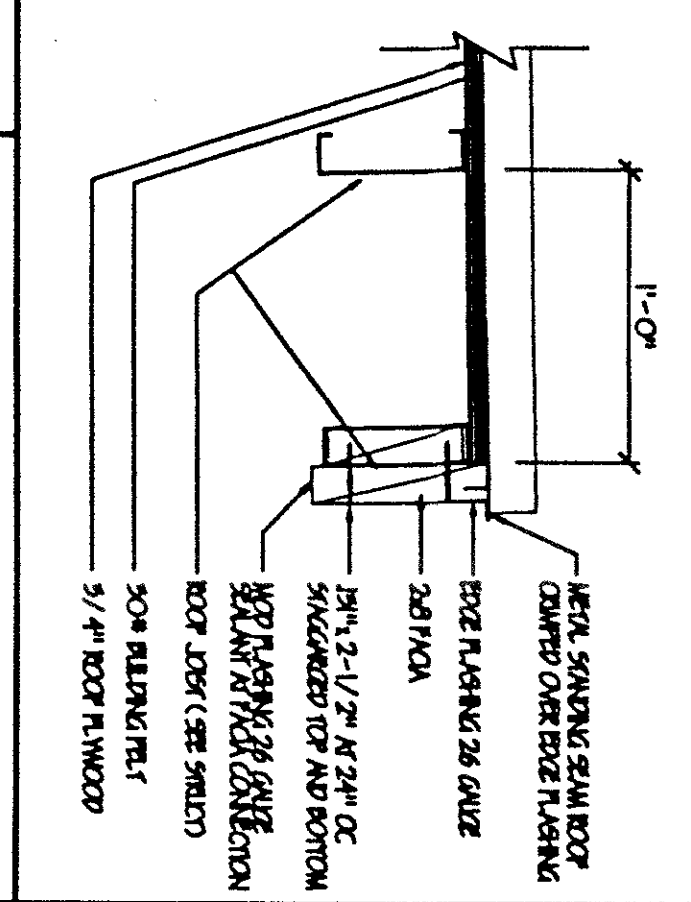
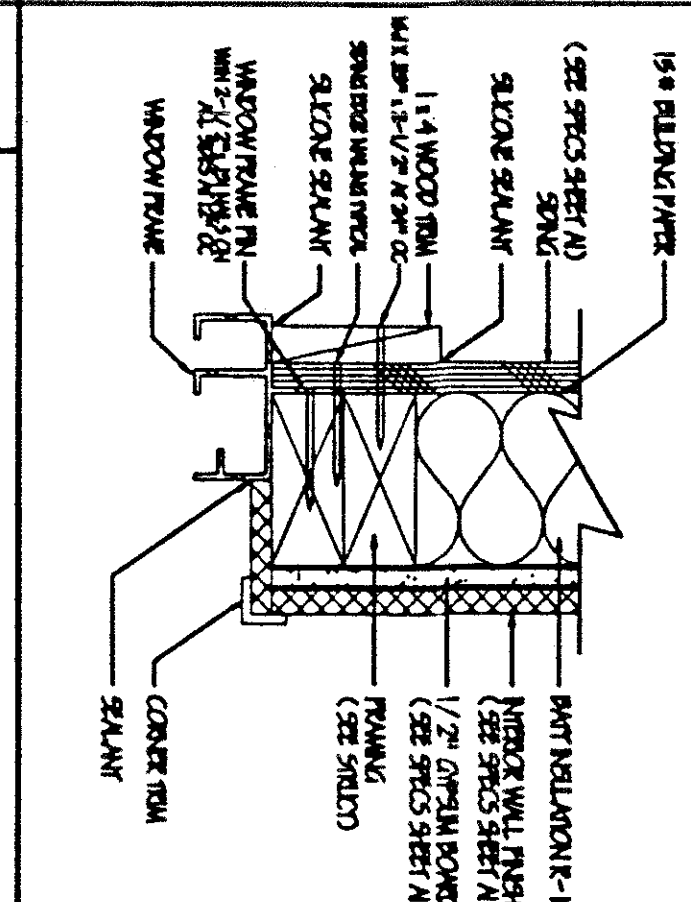
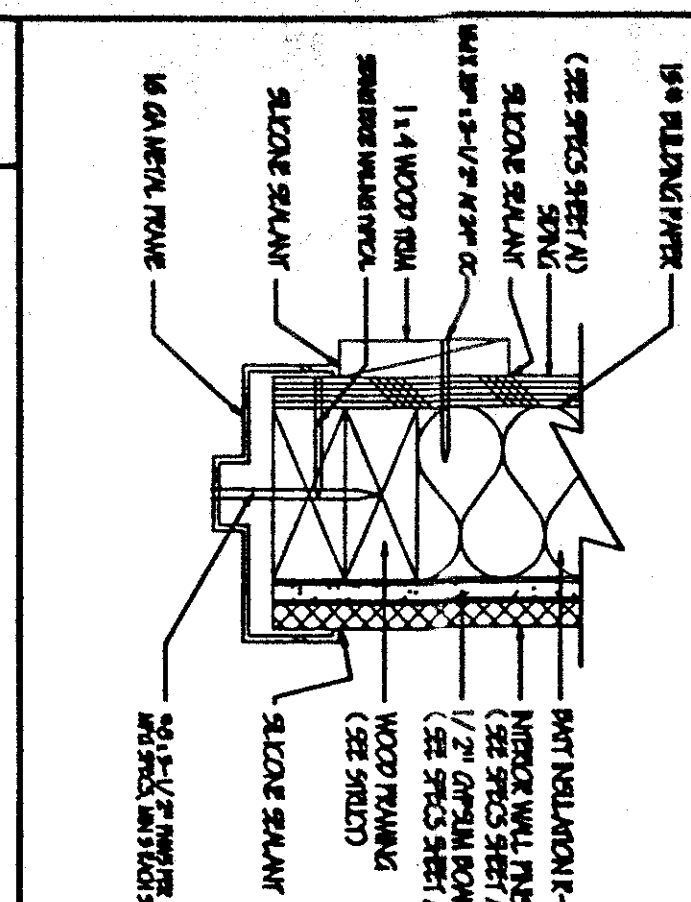

4 DOOR JAMB
SCALE: 1/2"=1'-0"

9 WINDOW JAMB
SCALE: 1/2"=1'-0"

15 ENTRY OVRHG
SCALE: 1/2"=1'-0"

17 OMG ALTERNATE
SCALE: 1/2"=1'-0"

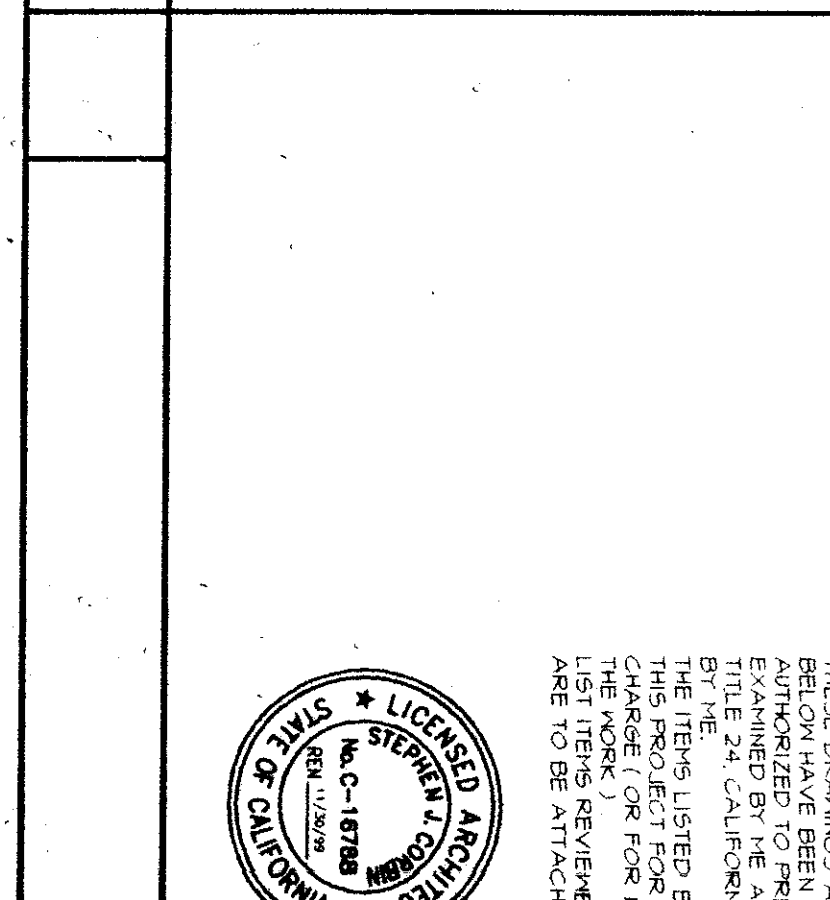
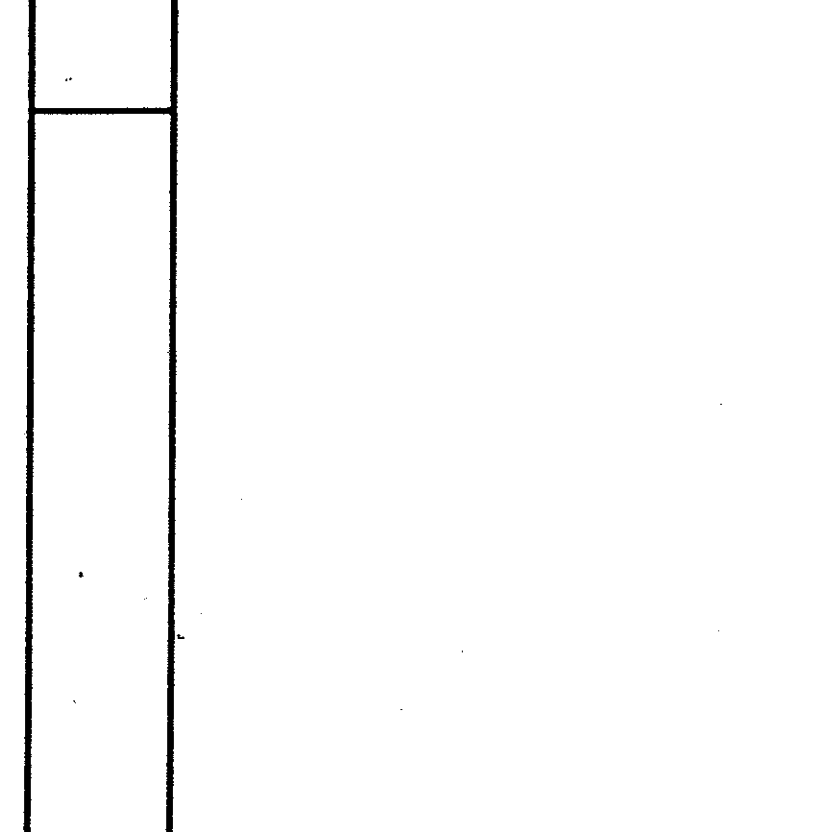
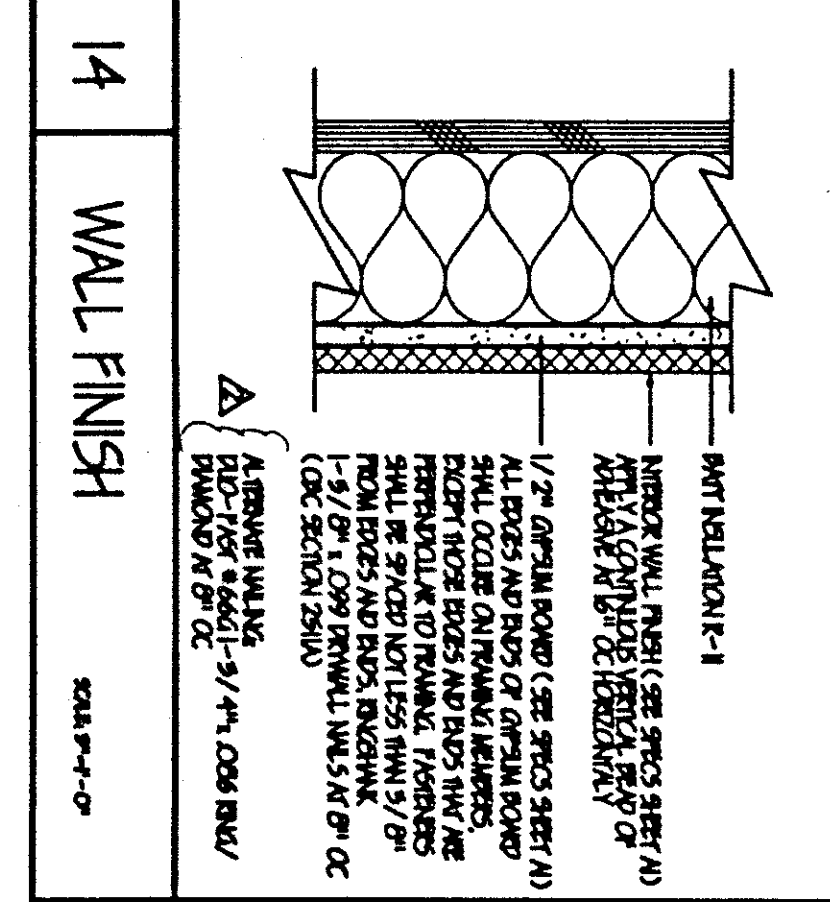
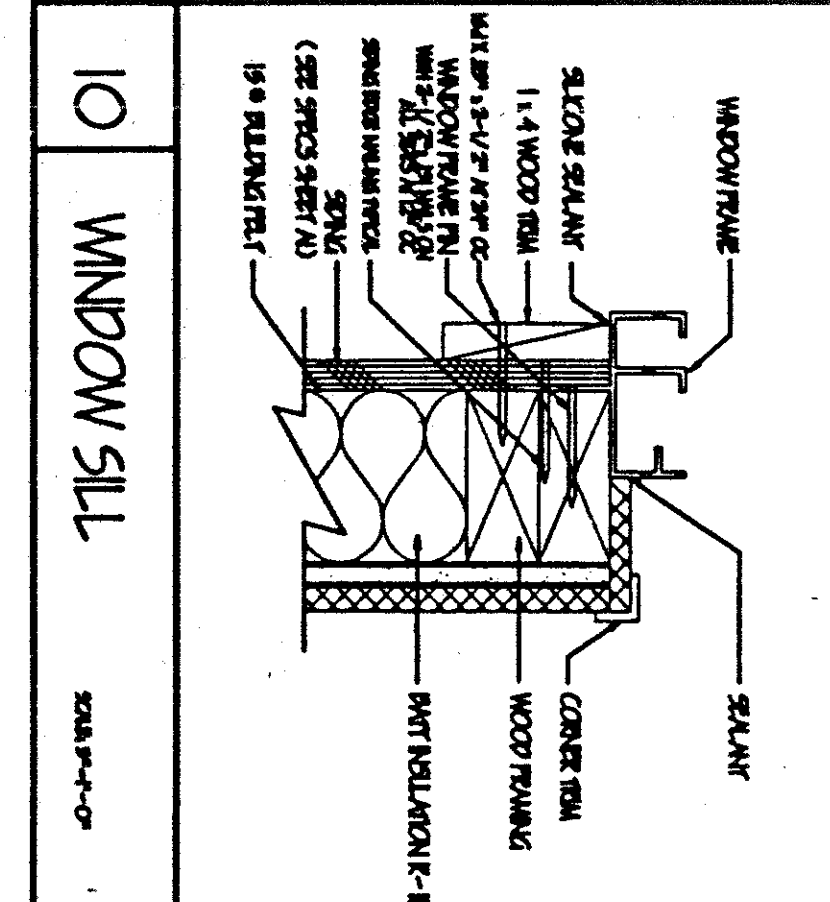
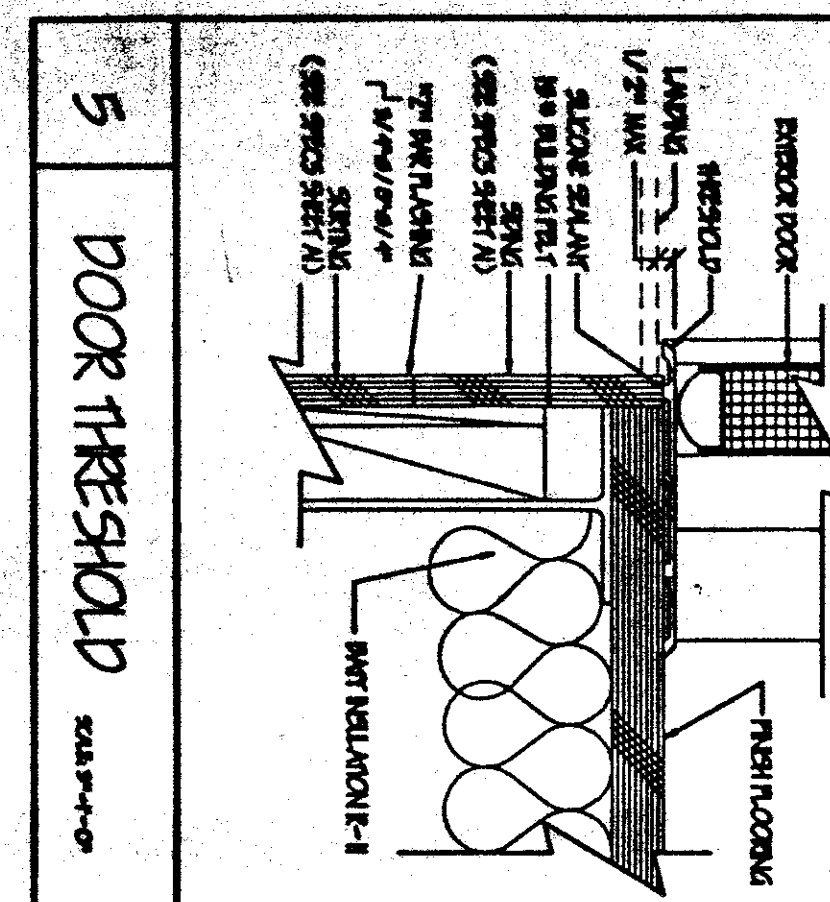

5 DOOR THRESHOLD
SCALE: 1/2"=1'-0"

10 WINDOW SILL
SCALE: 1/2"=1'-0"

14 WALL FINISH
SCALE: 1/2"=1'-0"

GENERAL NOTES

ALL FINISHES SHALL COMPLY WITH: OC
CHAPTERS 5, 6, 7, 8 AND 10

NORMAN A. GEIGER
AIA, CSI, CDT, ICB0
P.O. BOX 41064
Sacramento, CA 95841
(916) 332-2453 FAX
(916) 332-2453 PHONE

ARCHITECTURAL SERVICES

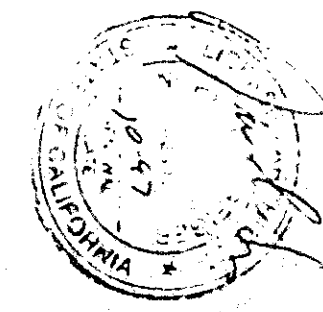

- ABBREVIATIONS
- PT OR FINISH
 - ALUMINUM
 - GLASS
 - WOOD
 - CONCRETE
 - INSULATION
 - ROOFING
 - MECHANICAL
 - ELECTRICAL
 - PLUMBING
 - PAINT
 - GLASS
 - STEEL

LEGEND

- PARTITION
- WOOD MEMBER
- ROOFING
- GLASS
- INSULATION
- FINISH

APPROVALS

DATE: FEB 20, 1997
REV. 01: MAR 15, 1997
REV. 02: MAY 20, 1997
REV. 03: JUL 25, 1997
REV. 04: SEP 25, 1997

DATE: _____
LIC. NO. _____

PACESETTER INDUSTRIES, INC.
P.O. BOX 1131, MODESTO, CA 95353 (209) 521-1600

24x40 RELOCATABLE BUILDING

GENERAL NOTES
DETAILS

DATE: FEB 20, 1997
REV. 01: MAR 15, 1997
REV. 02: MAY 20, 1997
REV. 03: JUL 25, 1997
REV. 04: SEP 25, 1997

DATE: _____
LIC. NO. _____

A6