

THESE DRAWINGS AND ALL MATERIAL CONTAINED HEREIN ARE THE PROPERTY OF SILVERCREEK INDUSTRIES, INC. (SCI INC) AND SHALL NOT BE REPRODUCED, COPIED OR OTHERWISE DISPOSED OF DIRECTLY OR INDIRECTLY AND SHALL NOT BE USED IN WHOLE OR IN PART TO ASSIST IN THE MAKING OF OR FOR THE PURPOSE OF FURNISHING ANY INFORMATION FOR THE MAKING OF DRAWINGS, PRINTS, APPARATUS OR PARTS THEREOF WITHOUT THE FULL KNOWLEDGE AND WRITTEN CONSENT OF SCI INC. ALL PATENTABLE MATERIAL CONTAINED HEREIN AND ORIGINATING WITH SCI INC SHALL BE THE PROPERTY OF SCI INC.

SILVER CREEK INDUSTRIES, INC.



195 EAST MORGAN FERRIS, CALIFORNIA 92571
PHONE: 951-943-8393 FAX: 951-943-2211

PROJECT NAME:
CLASS LEASING CLASSROOM BLDG'S

SHEET TITLE:
ROOF FRAMING DETAILS MONO SLOPE

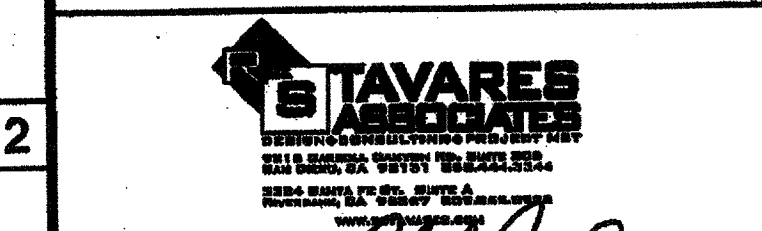

ARCHITECT OF RECORD
DIVISION OF THE STATE ARCHITECT
OFFICE OF REGULATION SERVICES
DATE: APR 11 2011

PROJECT SPECIFIC STATE AGENCY APPROVAL
IDENTIFICATION STAMP
DIV. OF THE STATE ARCHITECT
OFFICE OF REGULATION SERVICES
DATE: FEB 26 2015

ORIGINAL PC STATE AGENCY APPROVAL
IDENTIFICATION STAMP
DIV. OF THE STATE ARCHITECT
OFFICE OF REGULATION SERVICES
DATE: DEC 3 2010

REVISIONS

SILVER CREEK INDUSTRIES
24' x 40' PC

PROJECT NO:
DRAWN BY:
SCALE: AS NOTED
DATE: 12-23-11

P.C. SHEET NUMBER
S-2.50 STKP 126

IDENTIFICATION STAMP
DIV. OF THE STATE ARCHITECT
APPO3 116973
AC FLS SS
DATE APR 18 2010

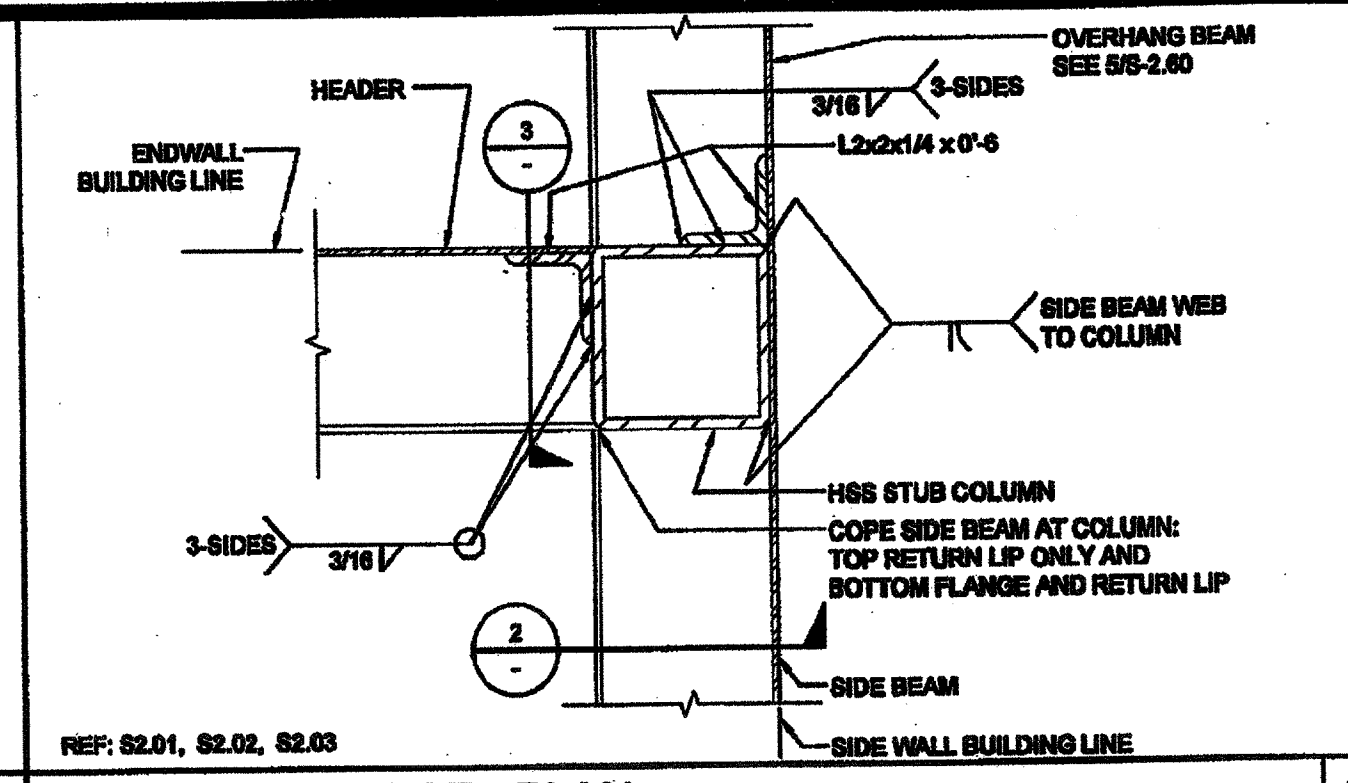

1 COLUMN AT ROOF - PLAN SCALE: 3"=1'-0" REF: S2.01, S2.02, S2.03

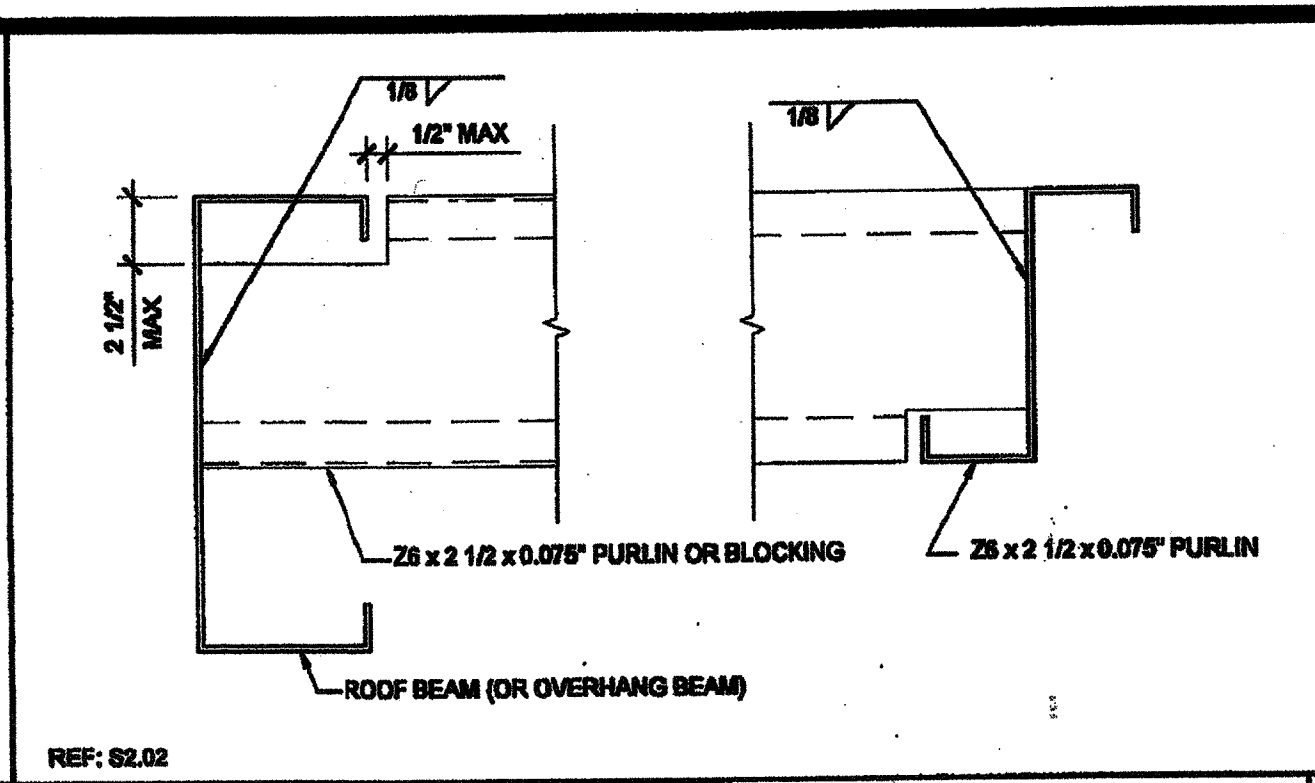

6 PURLIN CONNECTION DETAIL SCALE: 3"=1'-0" REF: S2.02

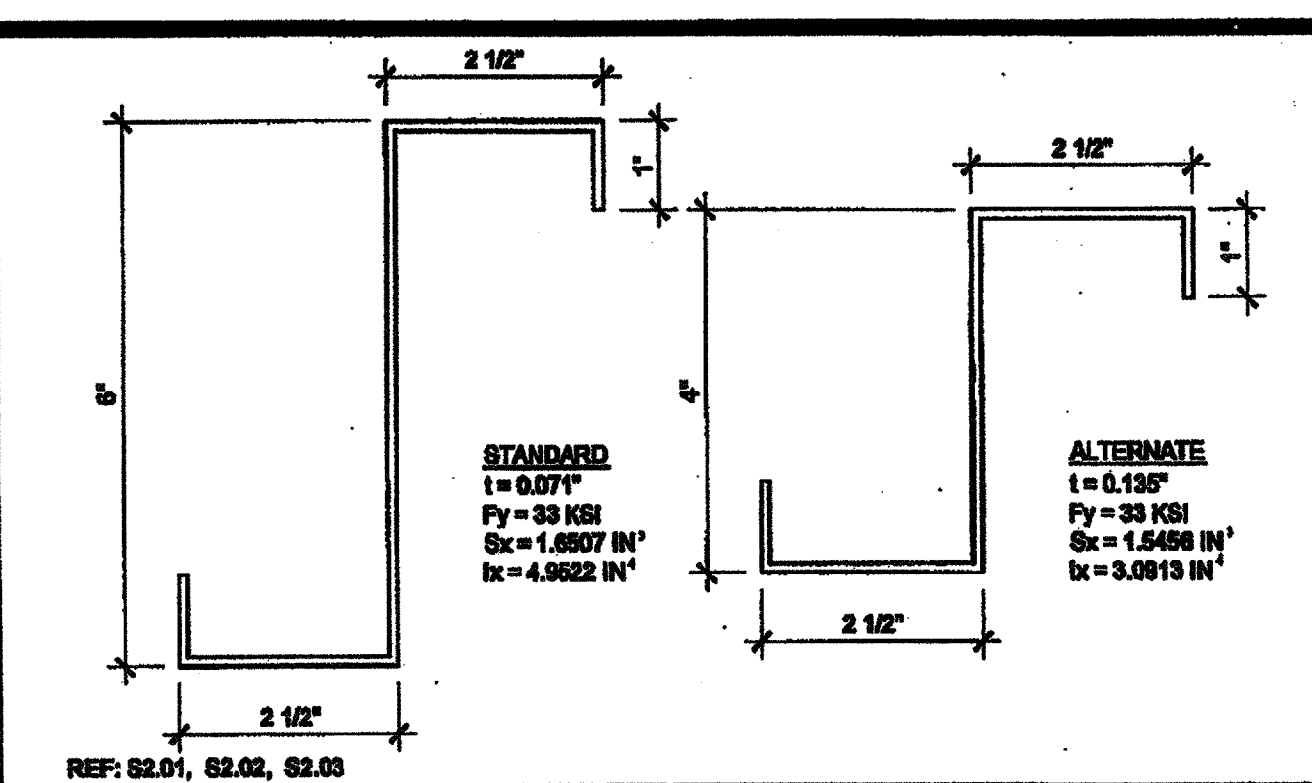

11 ROOF PURLIN SCALE: 6"=1'-0" REF: S2.01, S2.02, S2.03

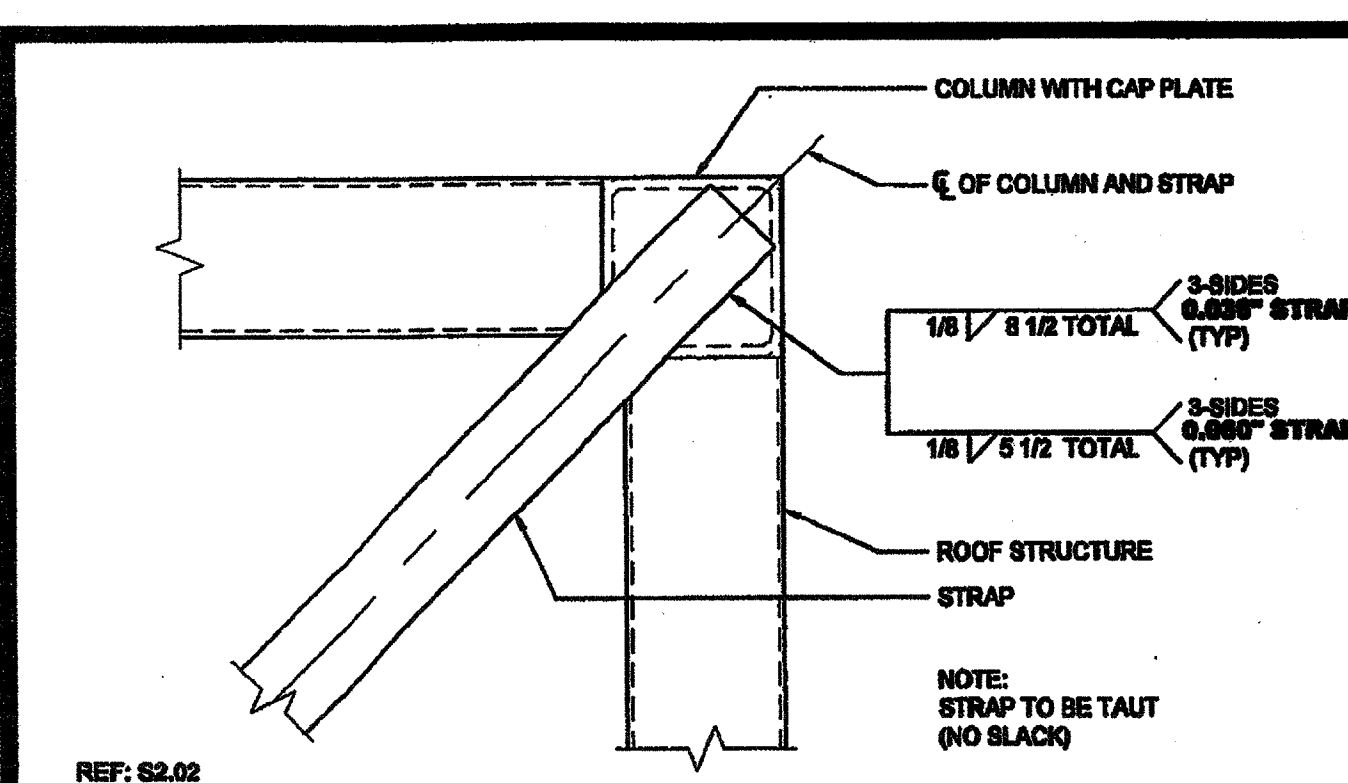

16 ROOF BRACING STRAP @ END WALL SCALE: 3"=1'-0" REF: S2.02

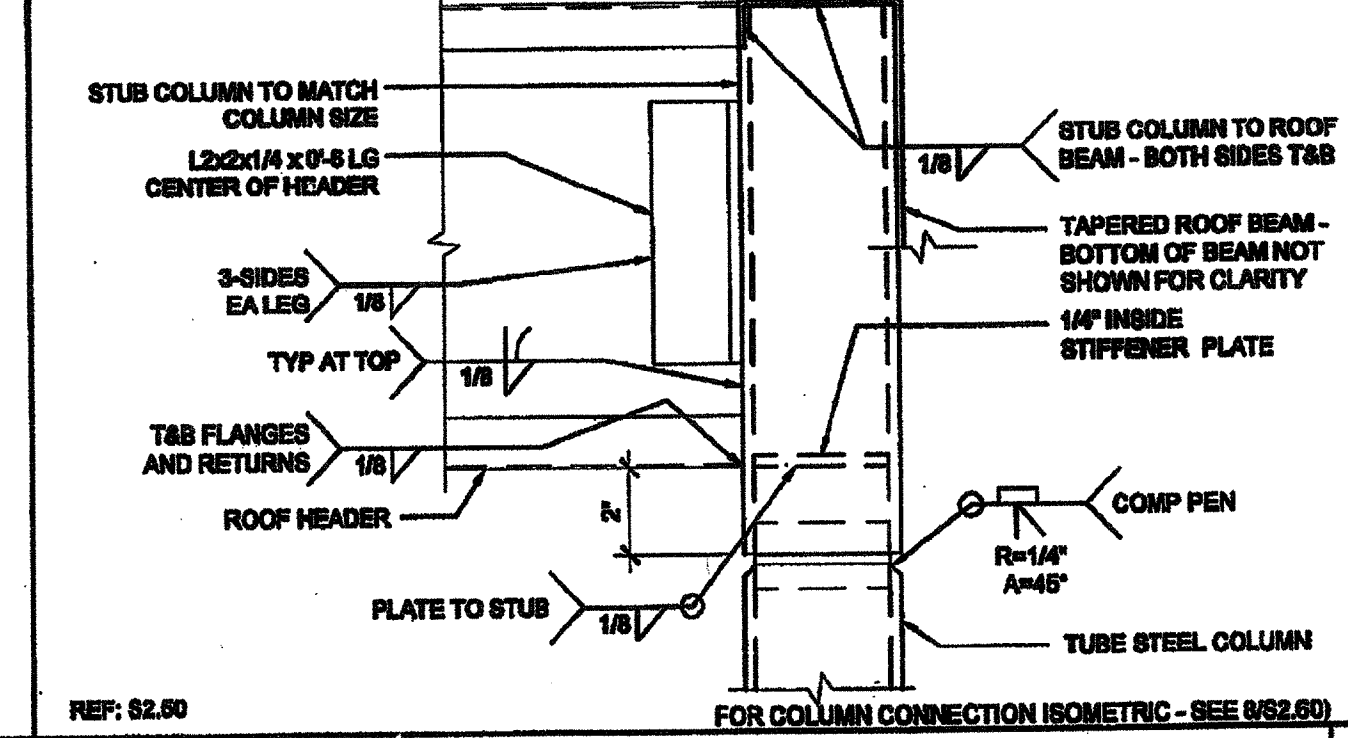

2 COLUMN AT ROOF - SECTION SCALE: 3"=1'-0" REF: S2.00 FOR COLUMN CONNECTION ISOMETRIC - SEE 8/8-2.60

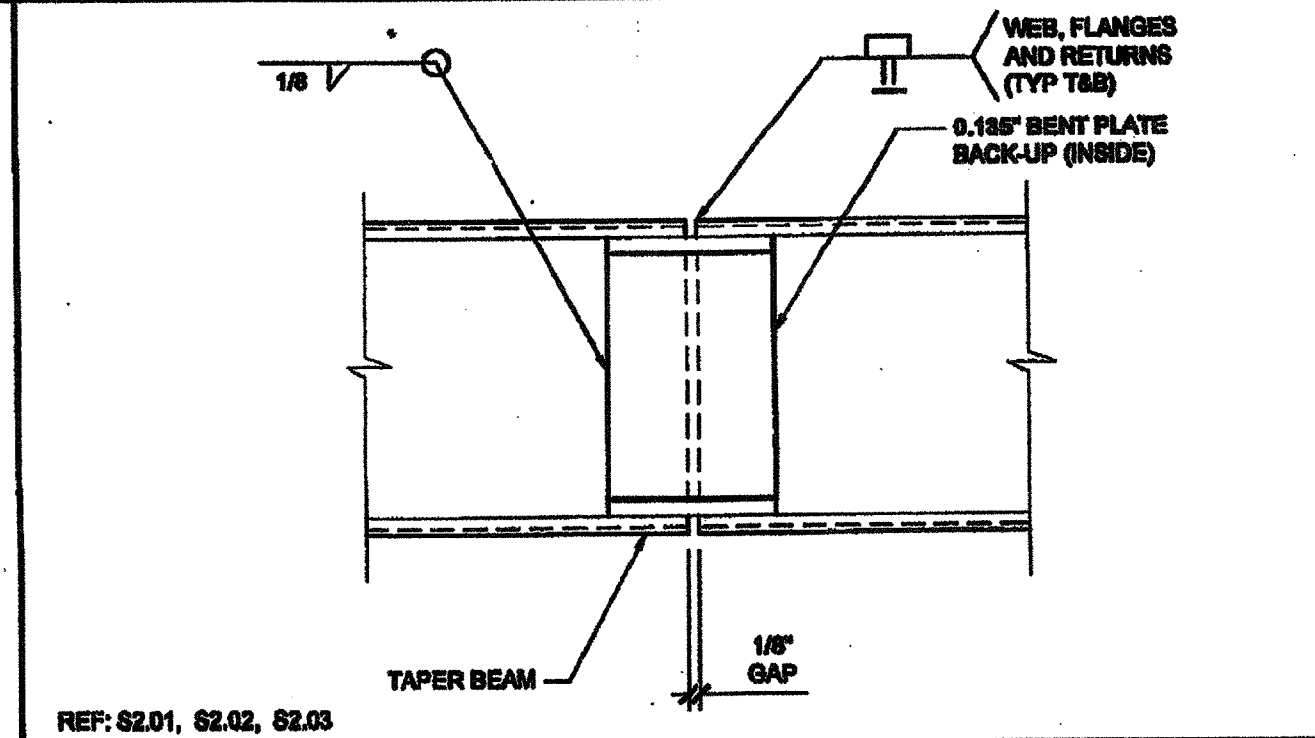

7 BEAM SPLICE SCALE: 3"=1'-0" REF: S2.01, S2.02, S2.03

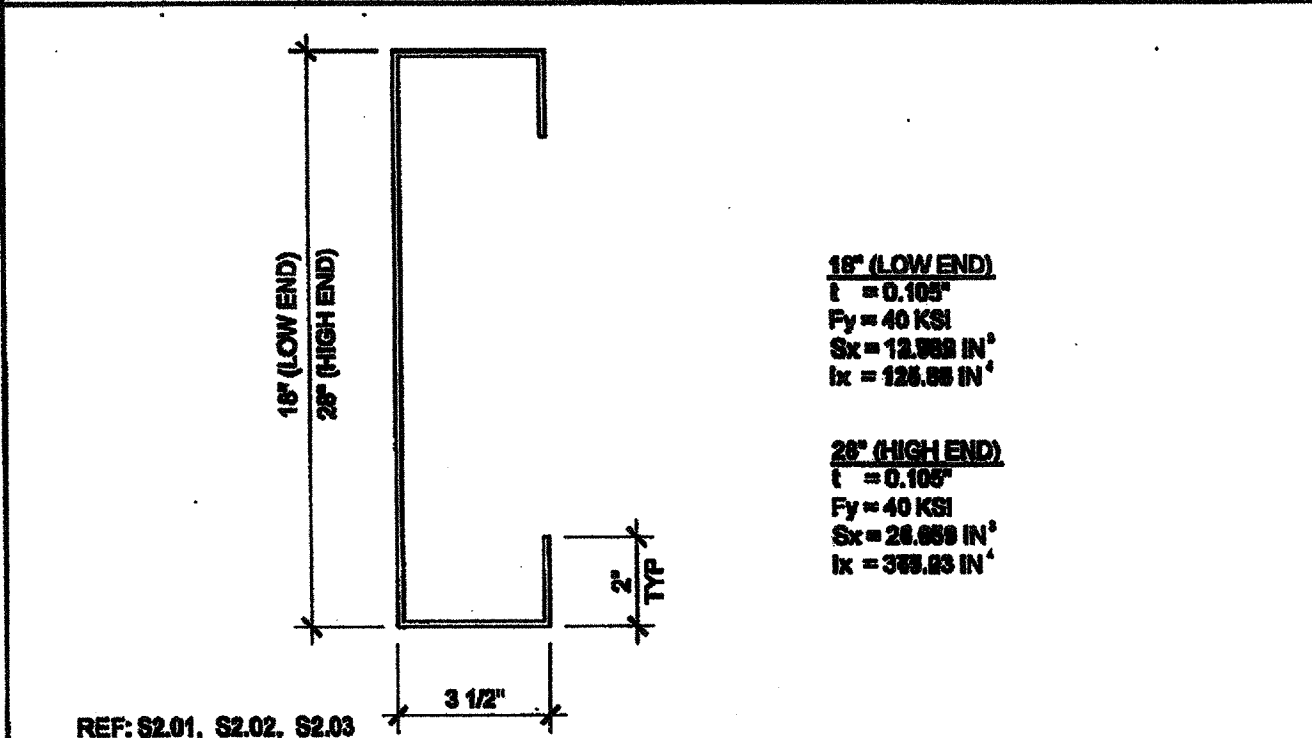

12 ROOF HEADER SCALE: NTS REF: S2.01, S2.02, S2.03

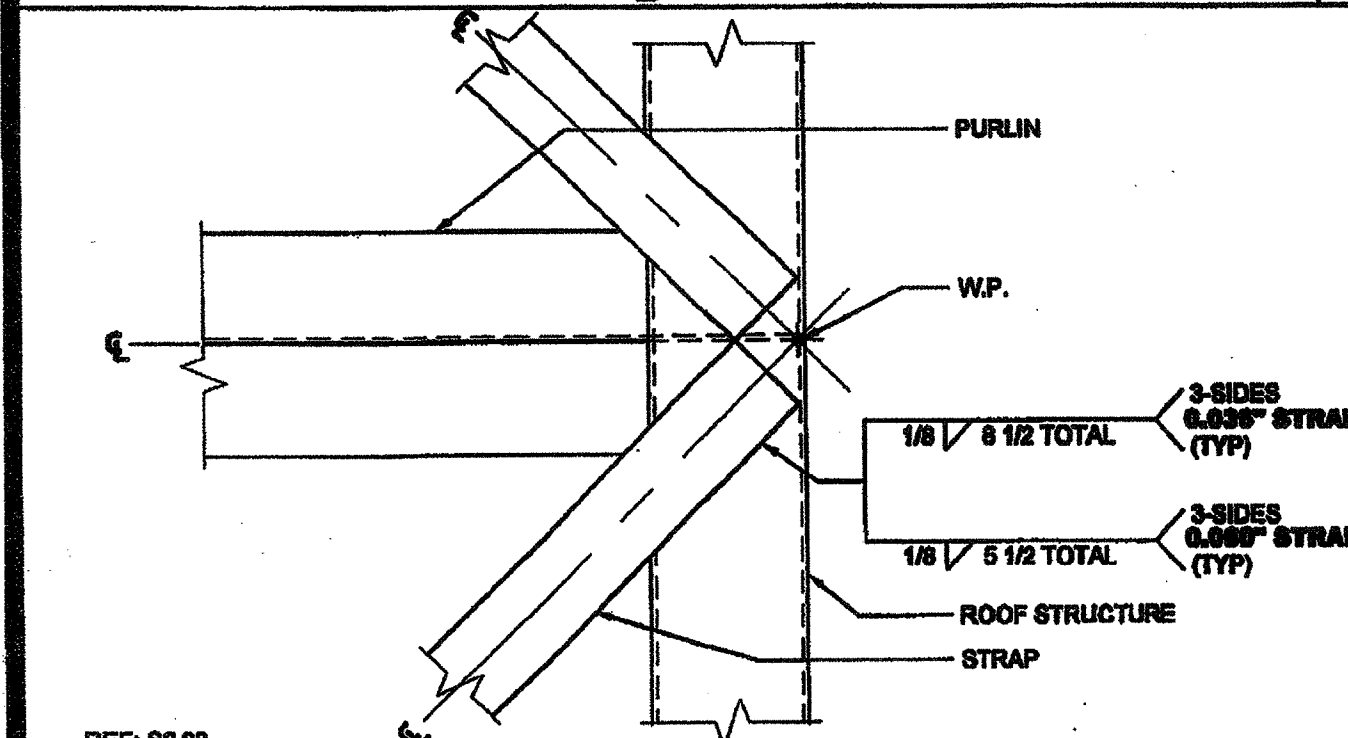

17 ROOF BRACING STRAP @ SIDE WALL SCALE: 3"=1'-0" REF: S2.02

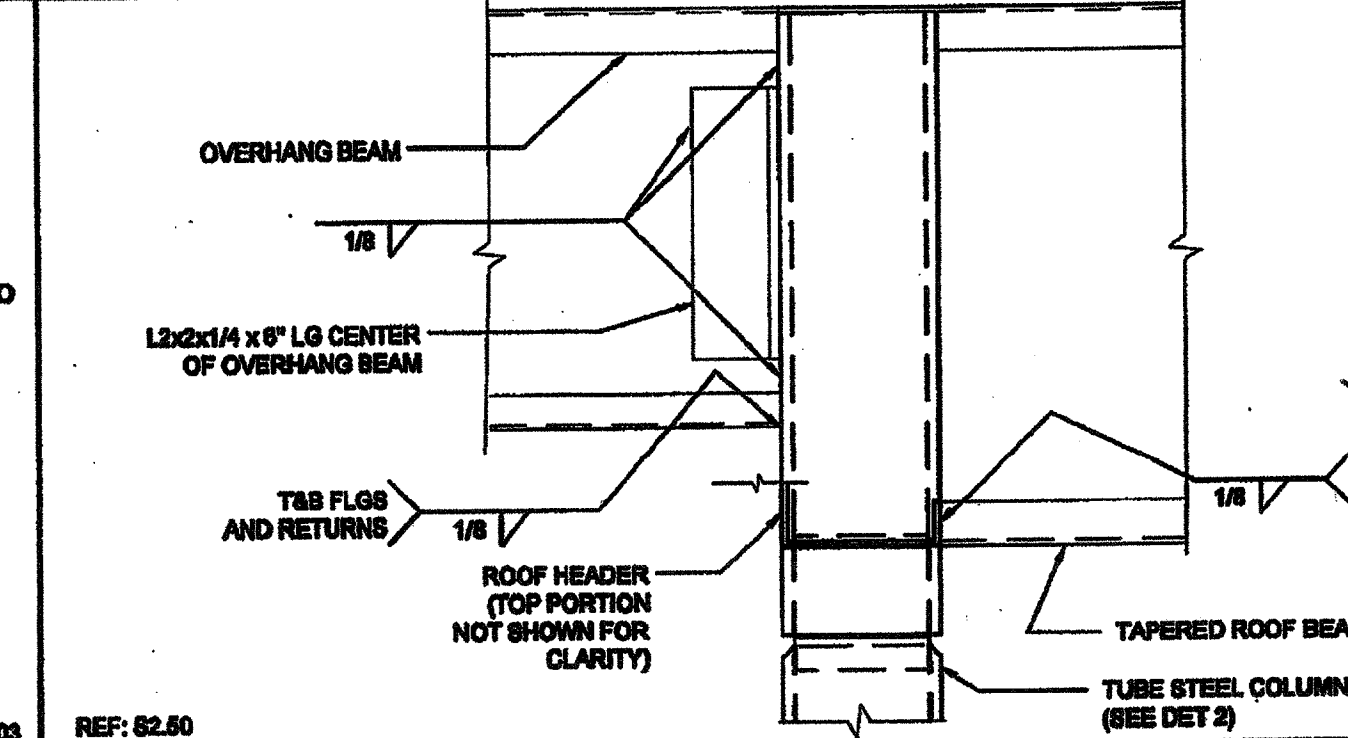

3 COLUMN AT ROOF OVERHANG SCALE: 3"=1'-0" REF: S2.00

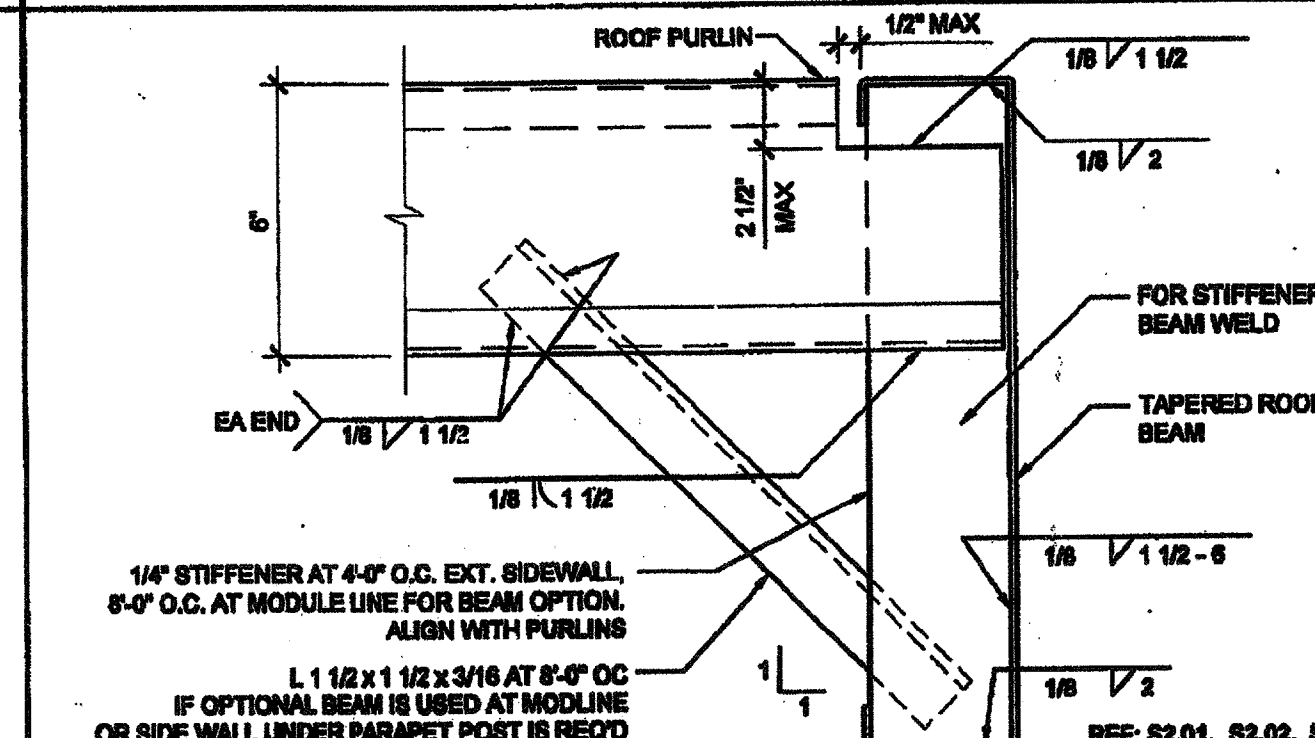

8 PURLIN TO ROOF BEAM @ STIFFENER SCALE: 3"=1'-0" REF: S2.01, S2.02, S2.03

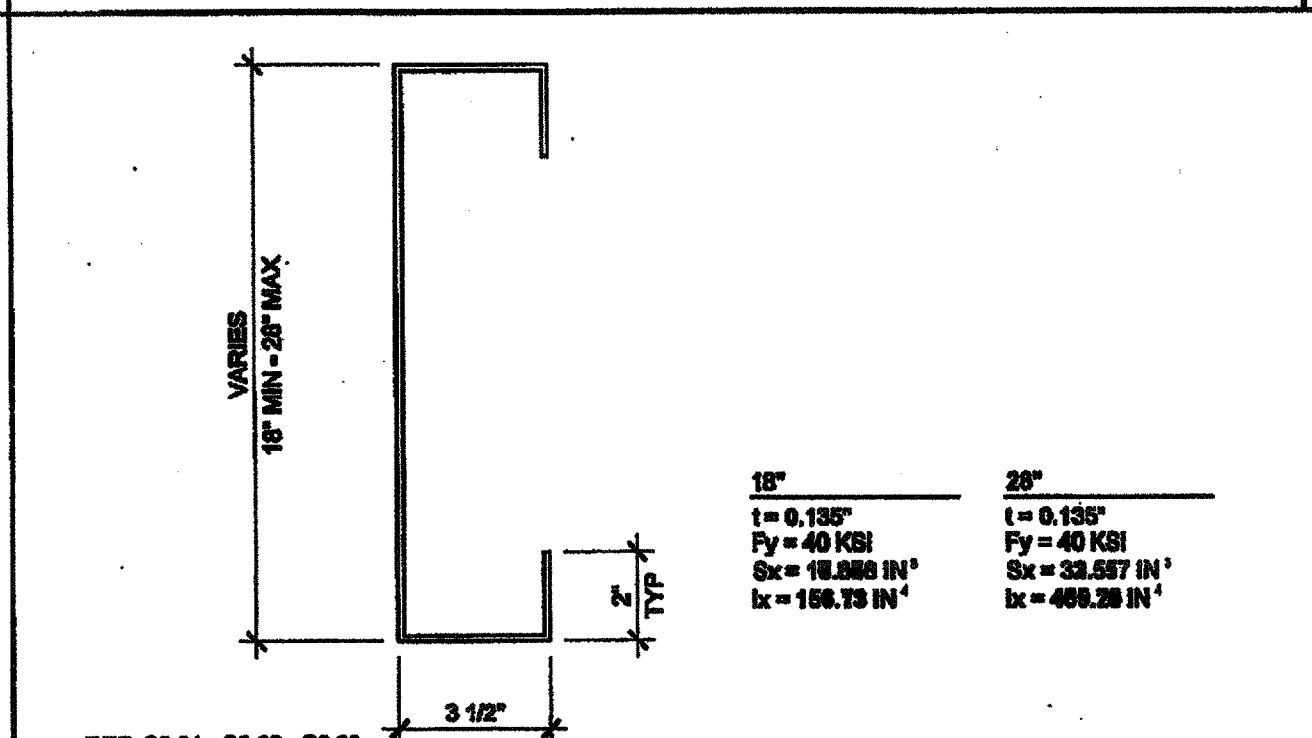

13 SIDE BEAM SCALE: NTS REF: S2.01, S2.02, S2.03

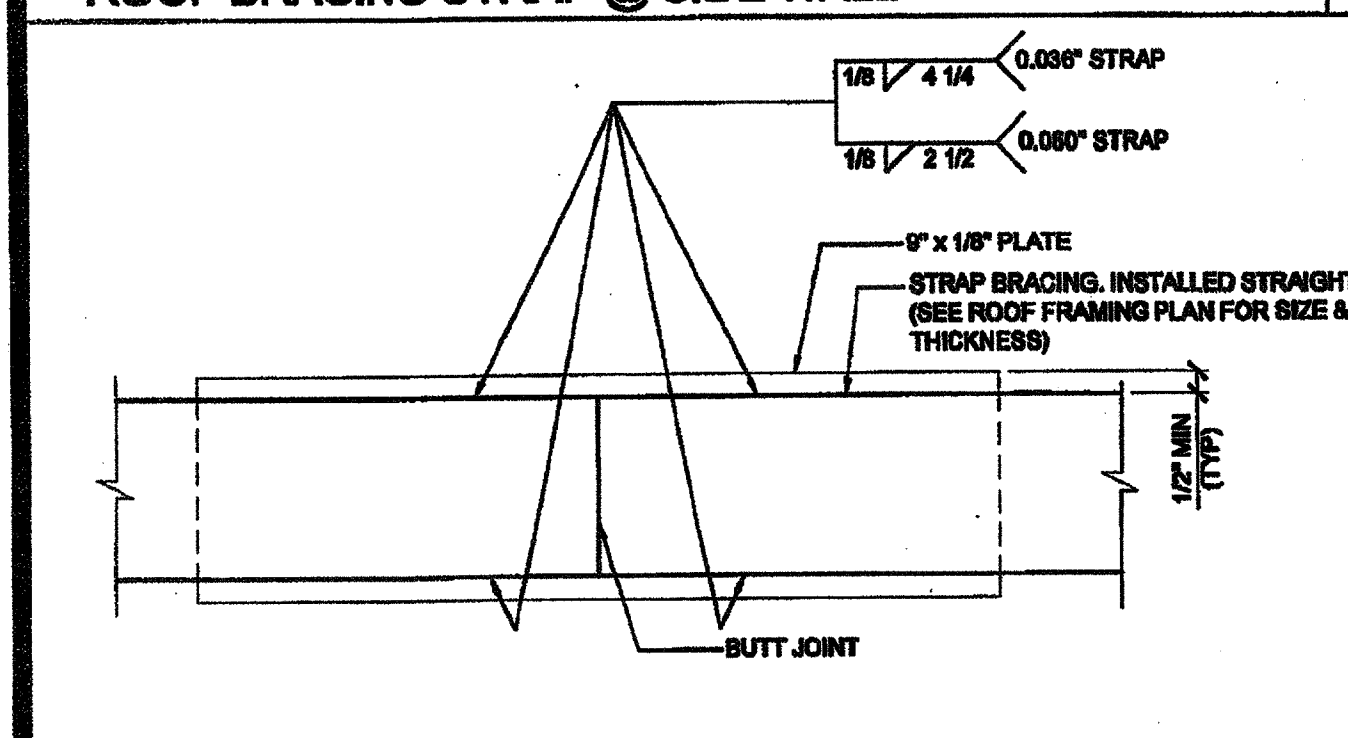

18 STRAP SPLICE DETAIL SCALE: 6"=1'-0" REF: S2.01, S2.02, S2.03

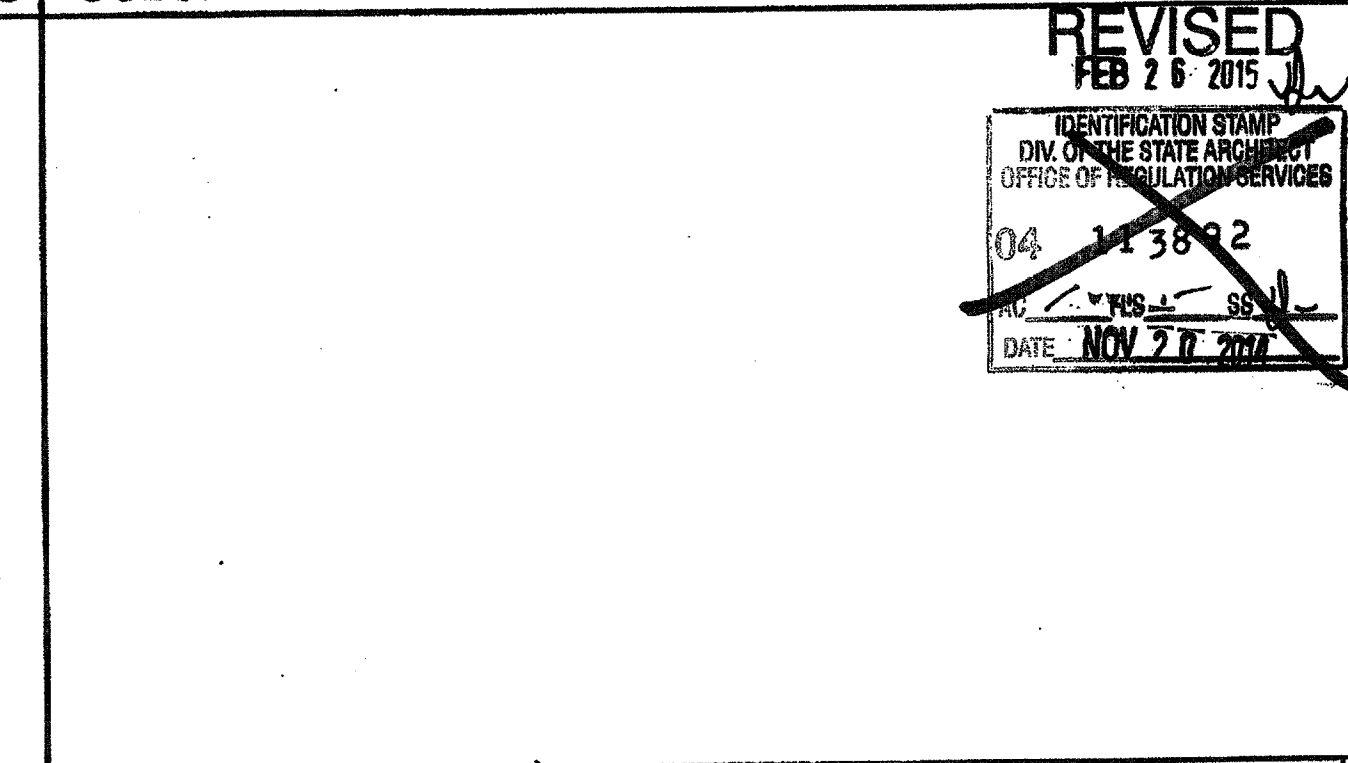

4 NOT USED

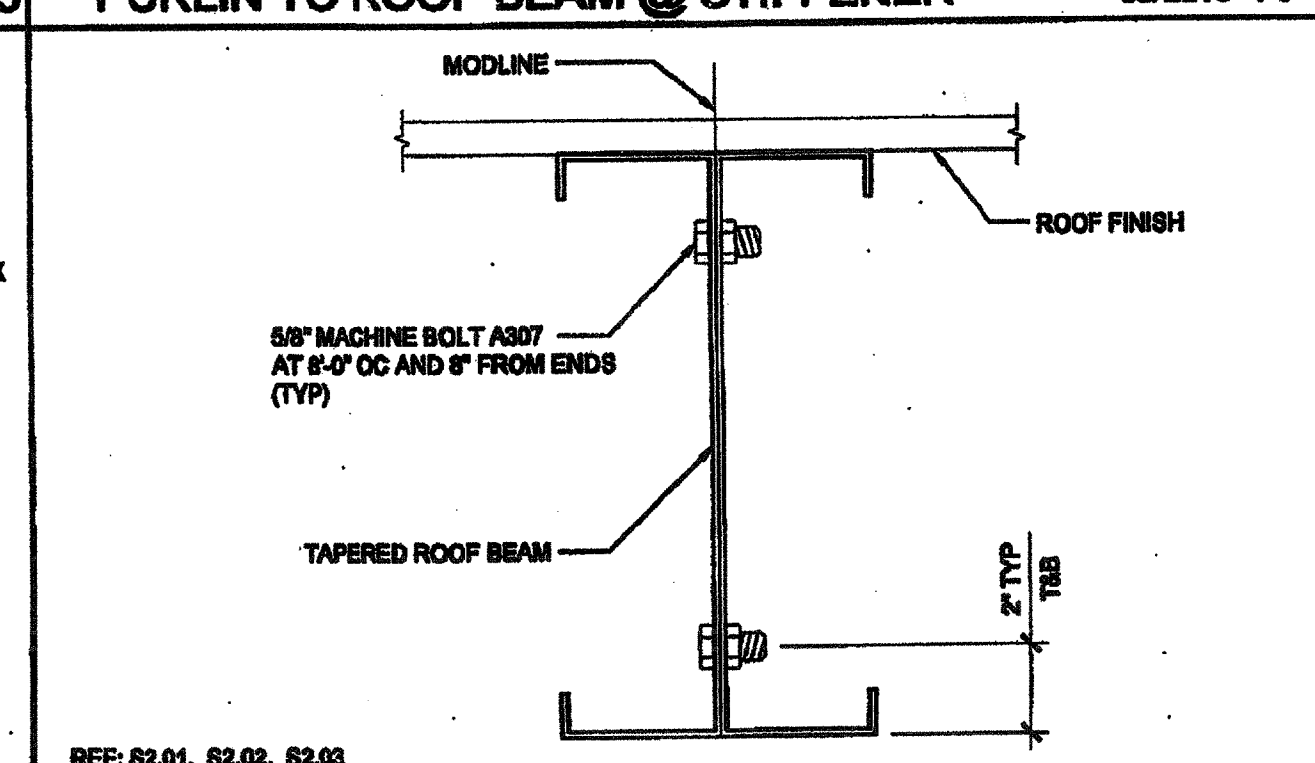

9 MODULE CONNECTION AT ROOF (OPTION) SCALE: 3"=1'-0" REF: S2.01, S2.02, S2.03

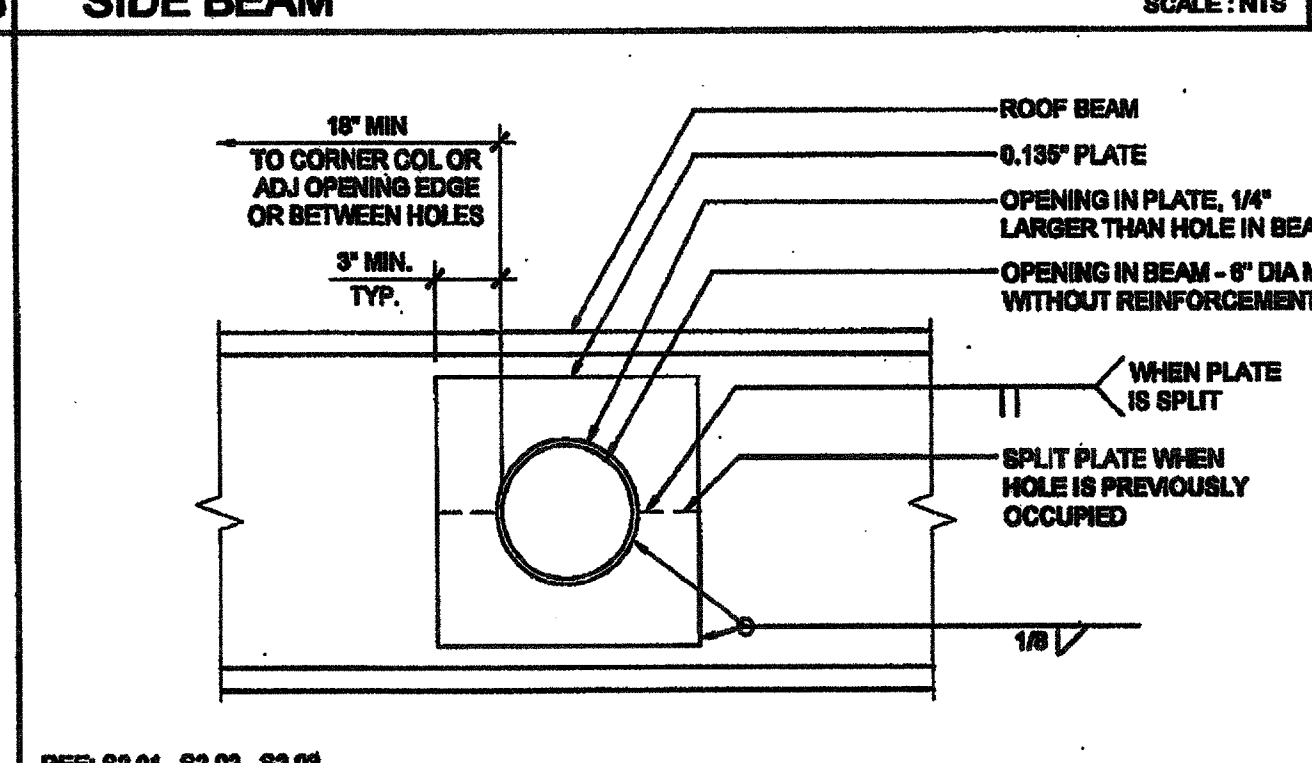

14 SIDEWALL BEAM PENETRATION SCALE: 1 1/2"=1'-0" REF: S2.01, S2.02, S2.03

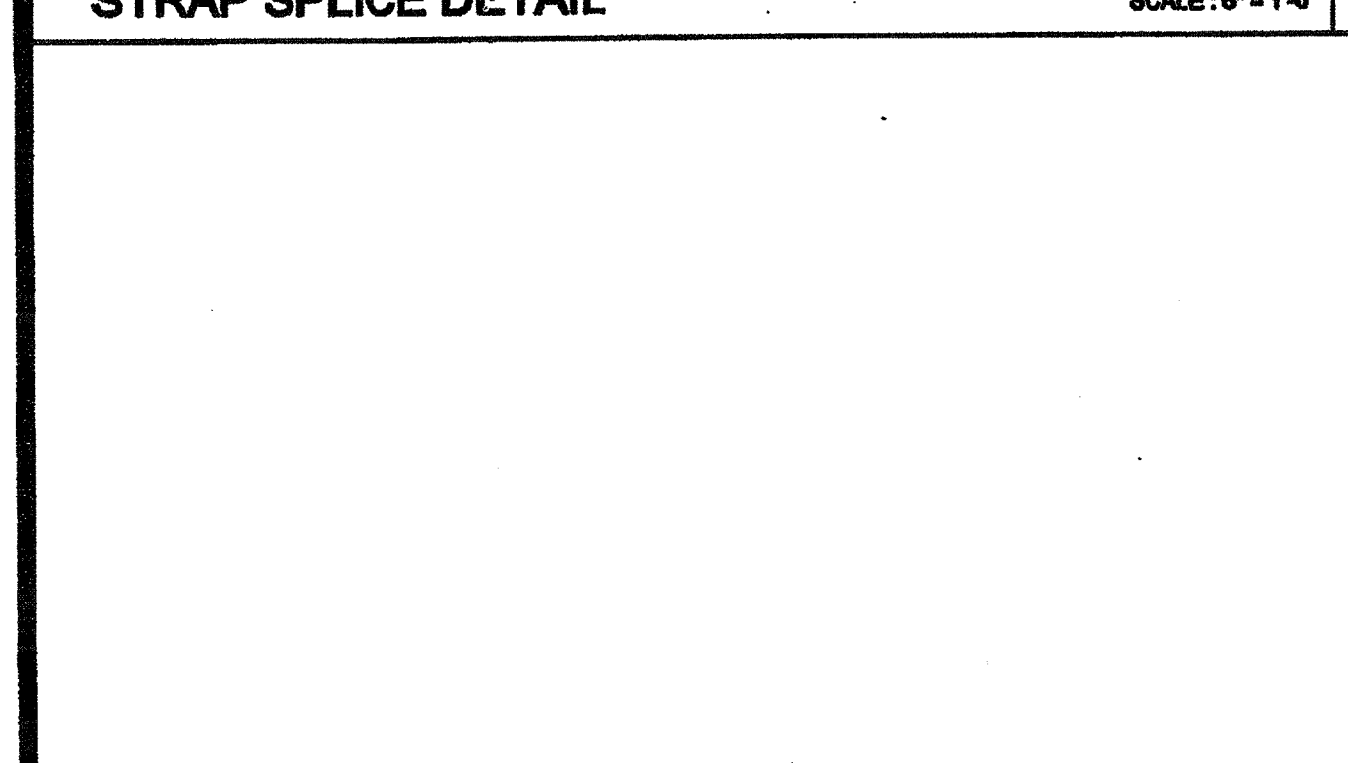

19 SIDEWALL BEAM PENETRATION SCALE: 1 1/2"=1'-0" REF: S2.01, S2.02, S2.03, S2.00

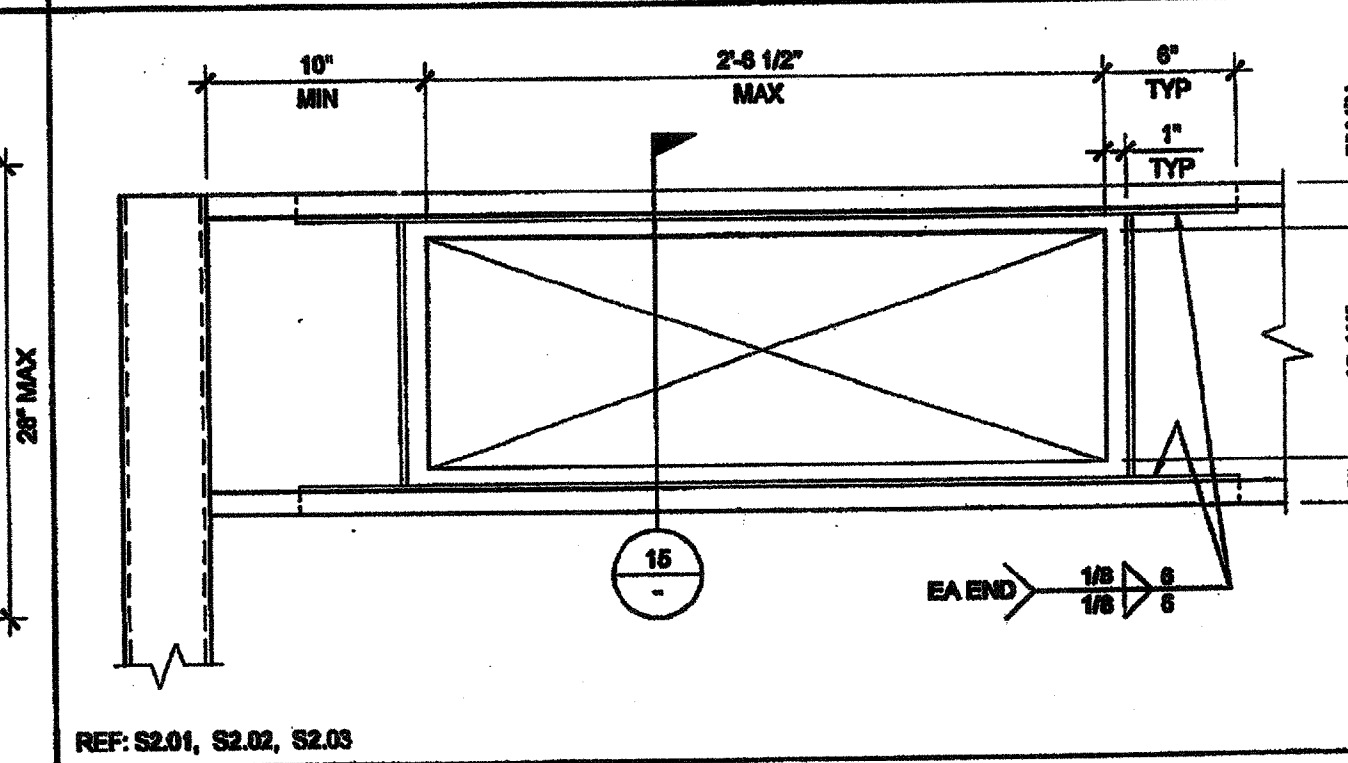

5 OPENING AT HEADER SCALE: 1 1/2"=1'-0" REF: S2.01, S2.02, S2.03

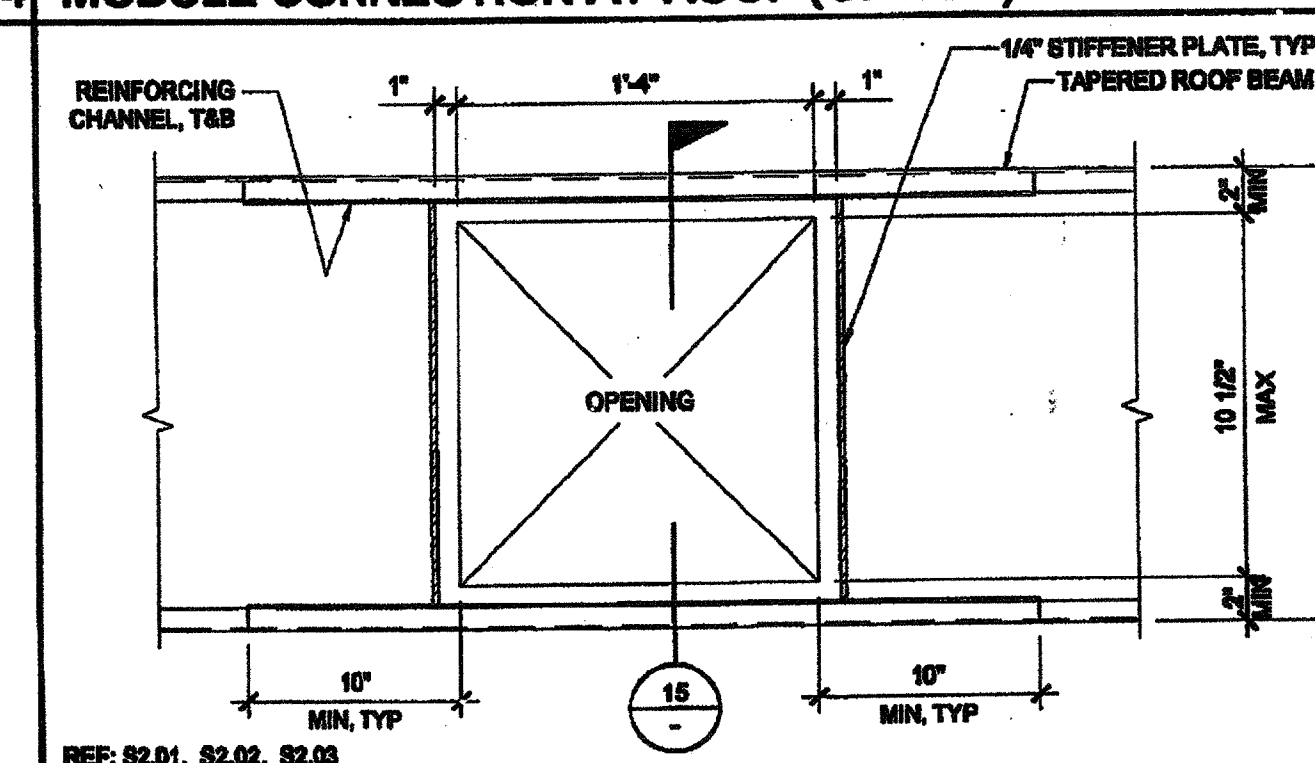

15 OPENING AT ROOF BEAM (OPTION) SCALE: 1 1/2"=1'-0" REF: S2.01, S2.02, S2.03

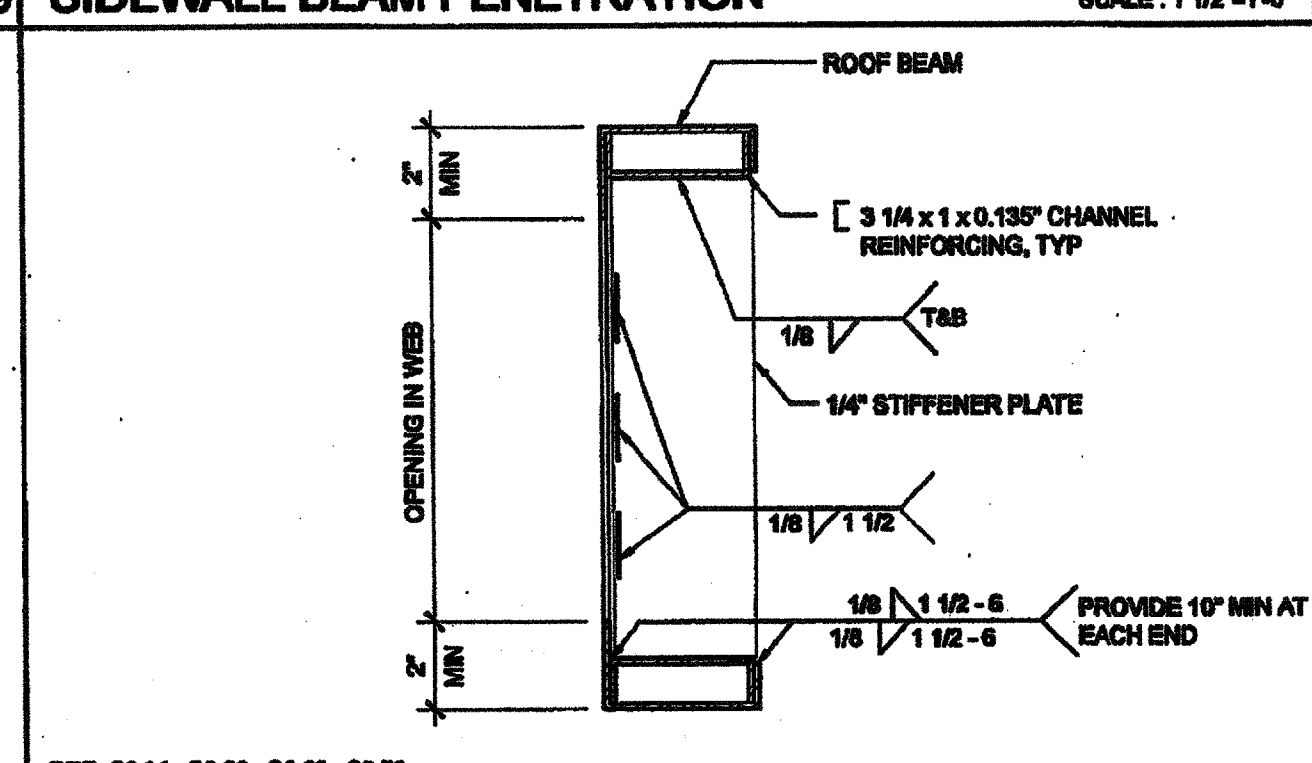

20 WEB OPENING AT ROOF BEAM (OPTION) SCALE: 3"=1'-0" REF: S2.01, S2.02, S2.03, S2.00

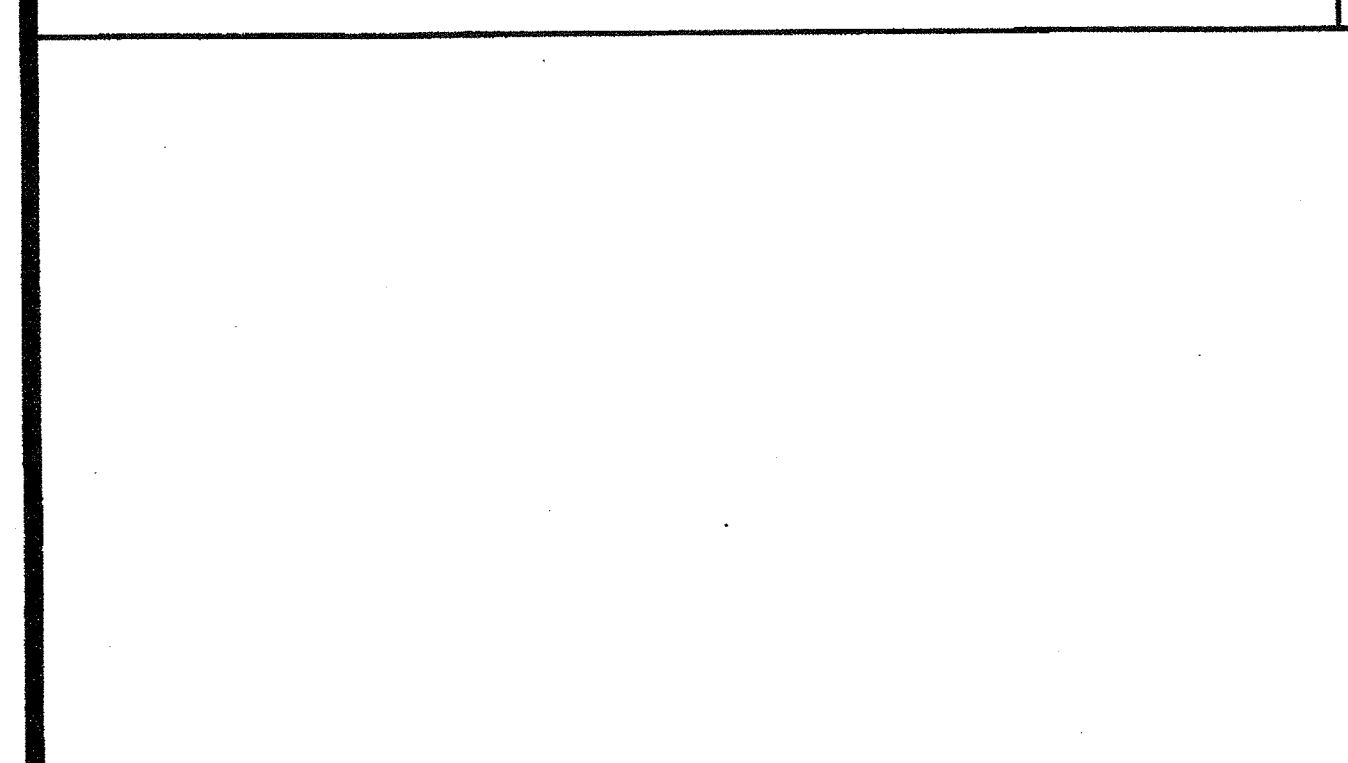

13 SIDE BEAM SCALE: NTS REF: S2.01, S2.02, S2.03