

16 FOUNDATION AT ADJACENT BUILDING SCALE: 3"=1'-0"

11 FOUNDATION ASSEMBLY END WALL ELEVATION SCALE: 1 1/2"=1'-0"

6 FOUNDATION AT END WALL SCALE: 3"=1'-0"

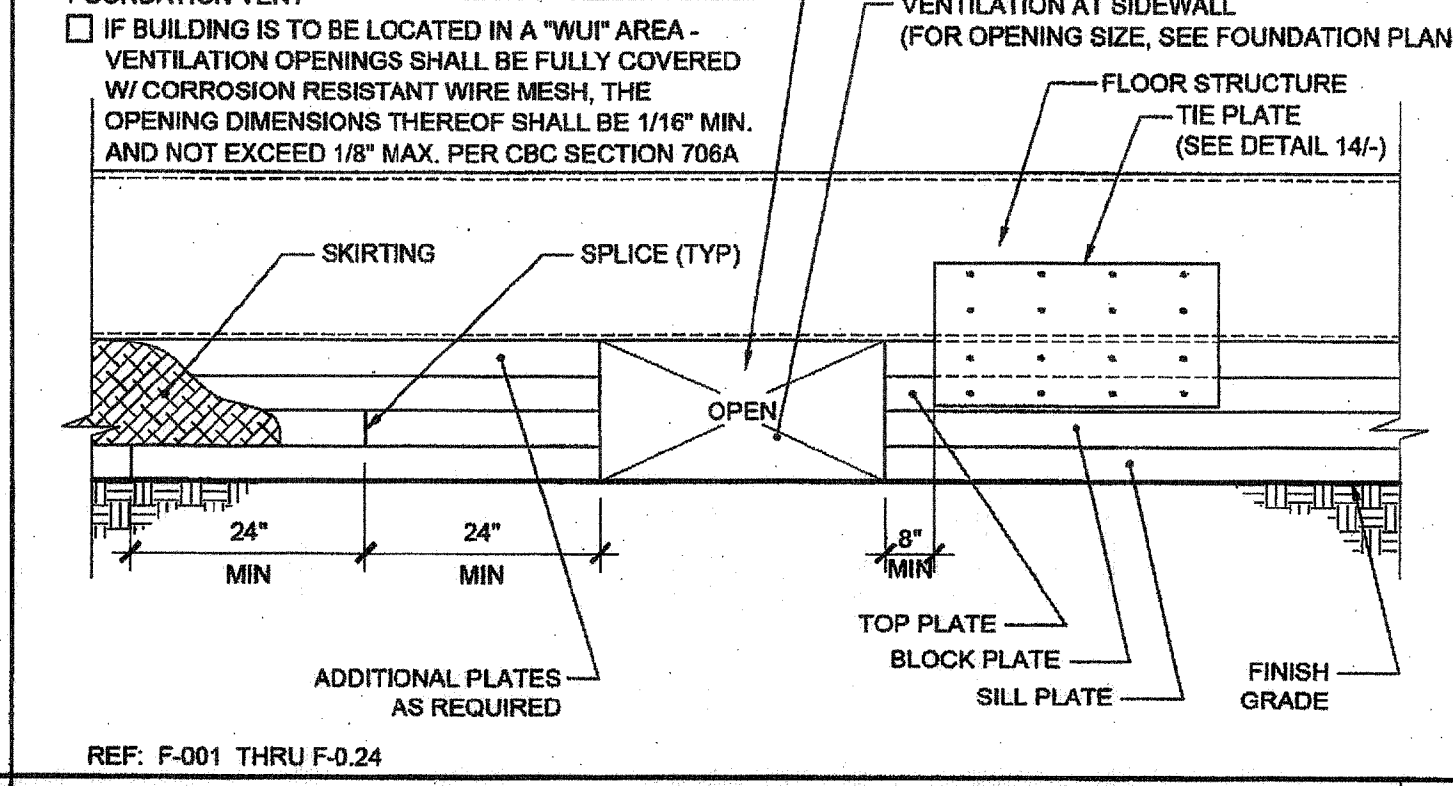
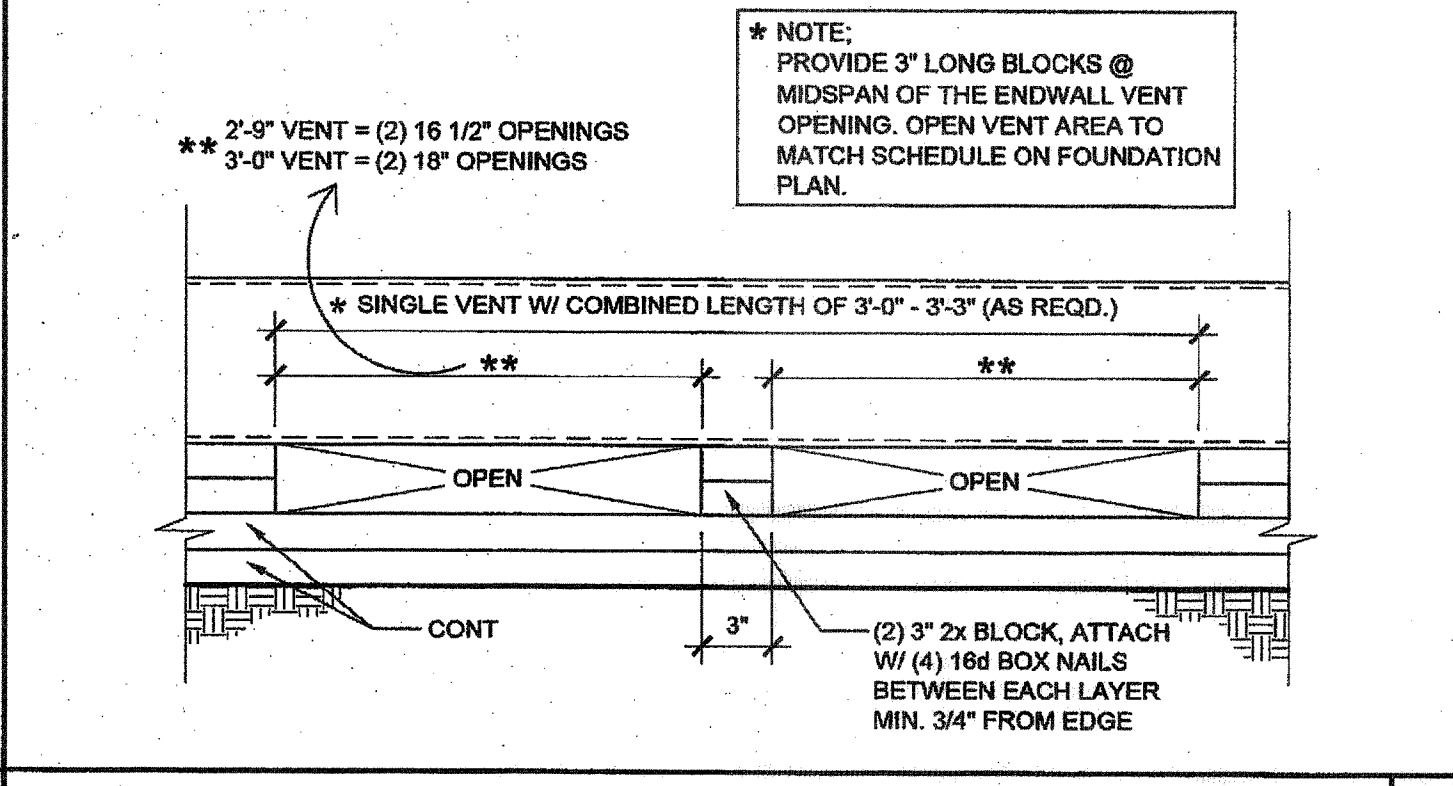
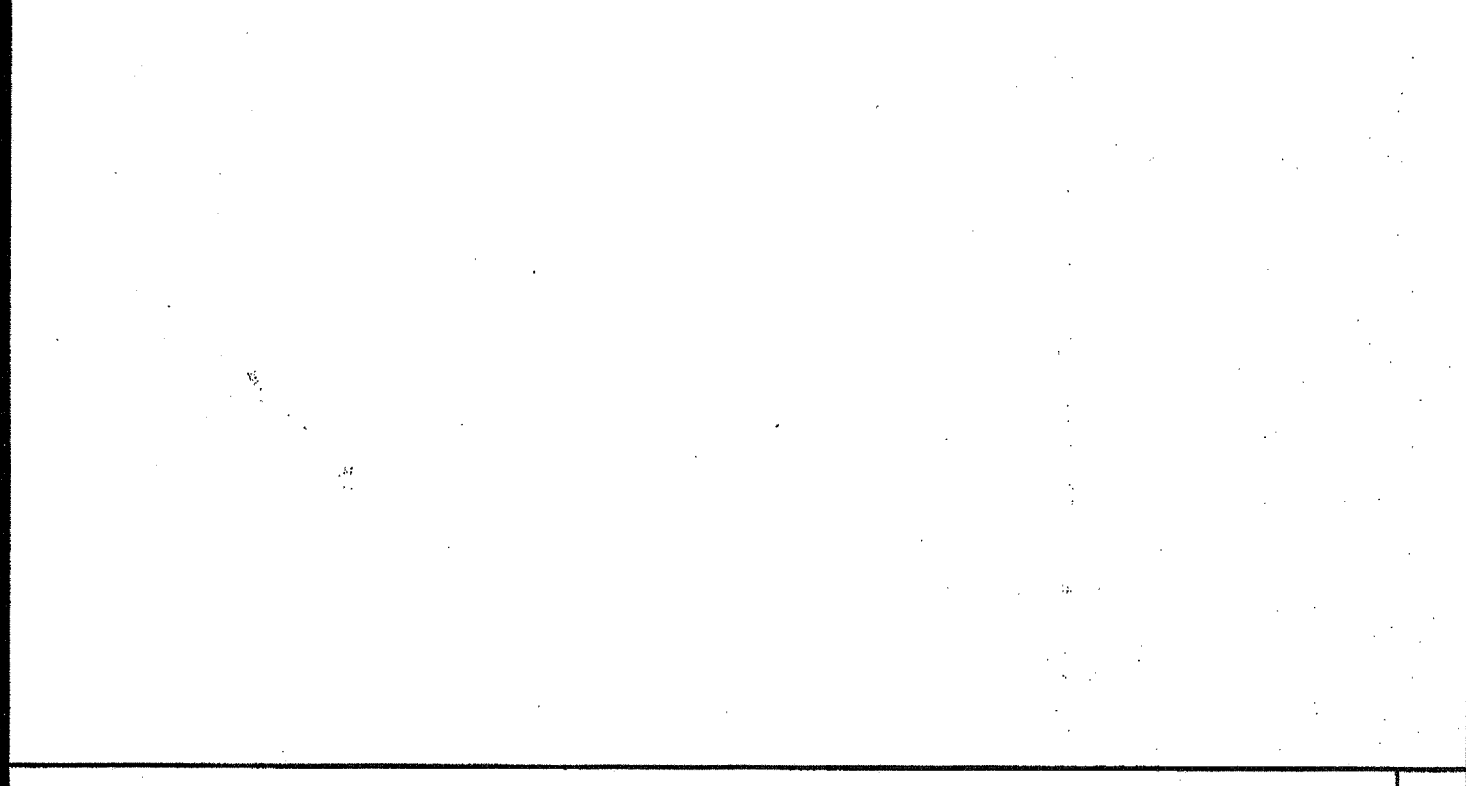

17 END WALL VENT SCALE: 1 1/2"=1'-0"

12 FOUNDATION ASSEMBLY SIDEWALL ELEVATION SCALE: 1 1/2"=1'-0"

7 FOUNDATION AT SIDE WALL SCALE: 3"=1'-0"

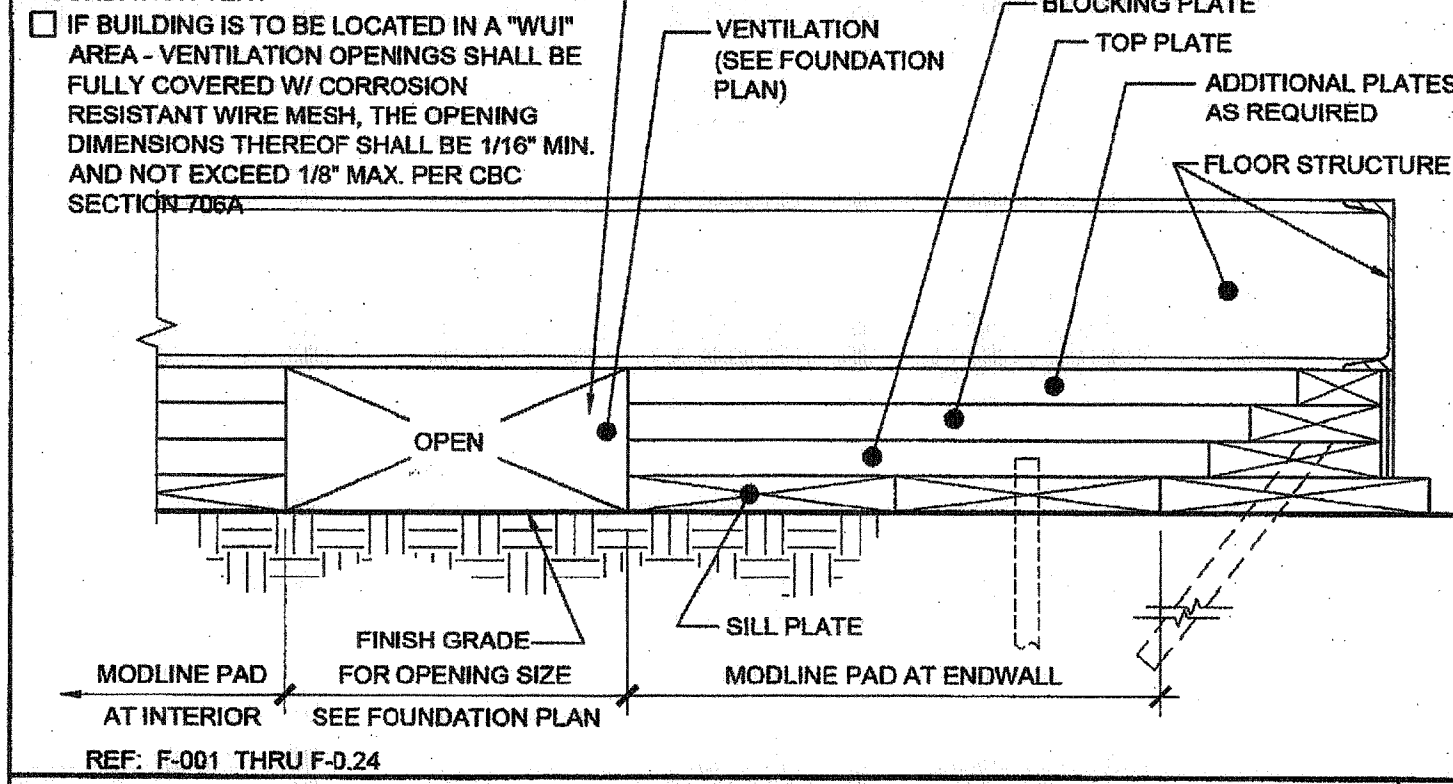
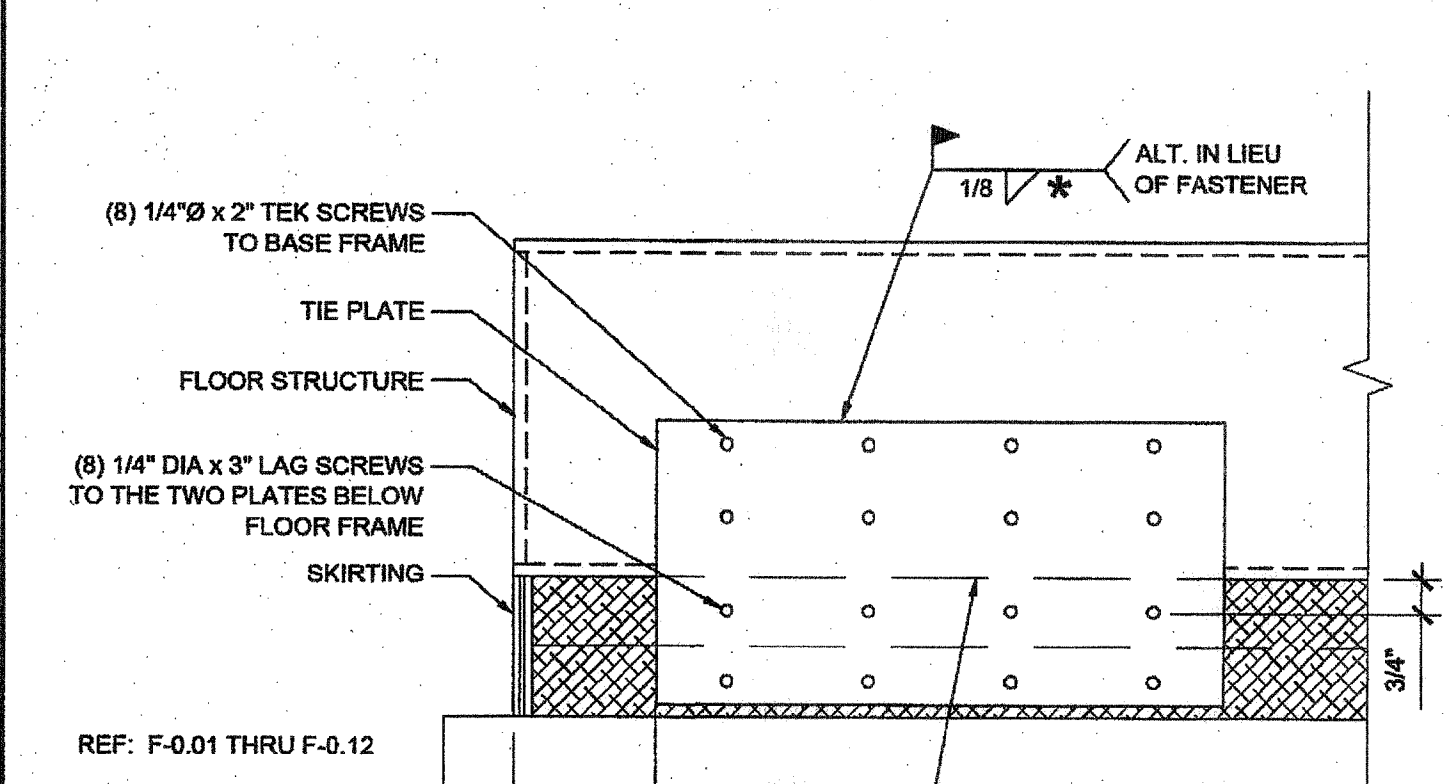
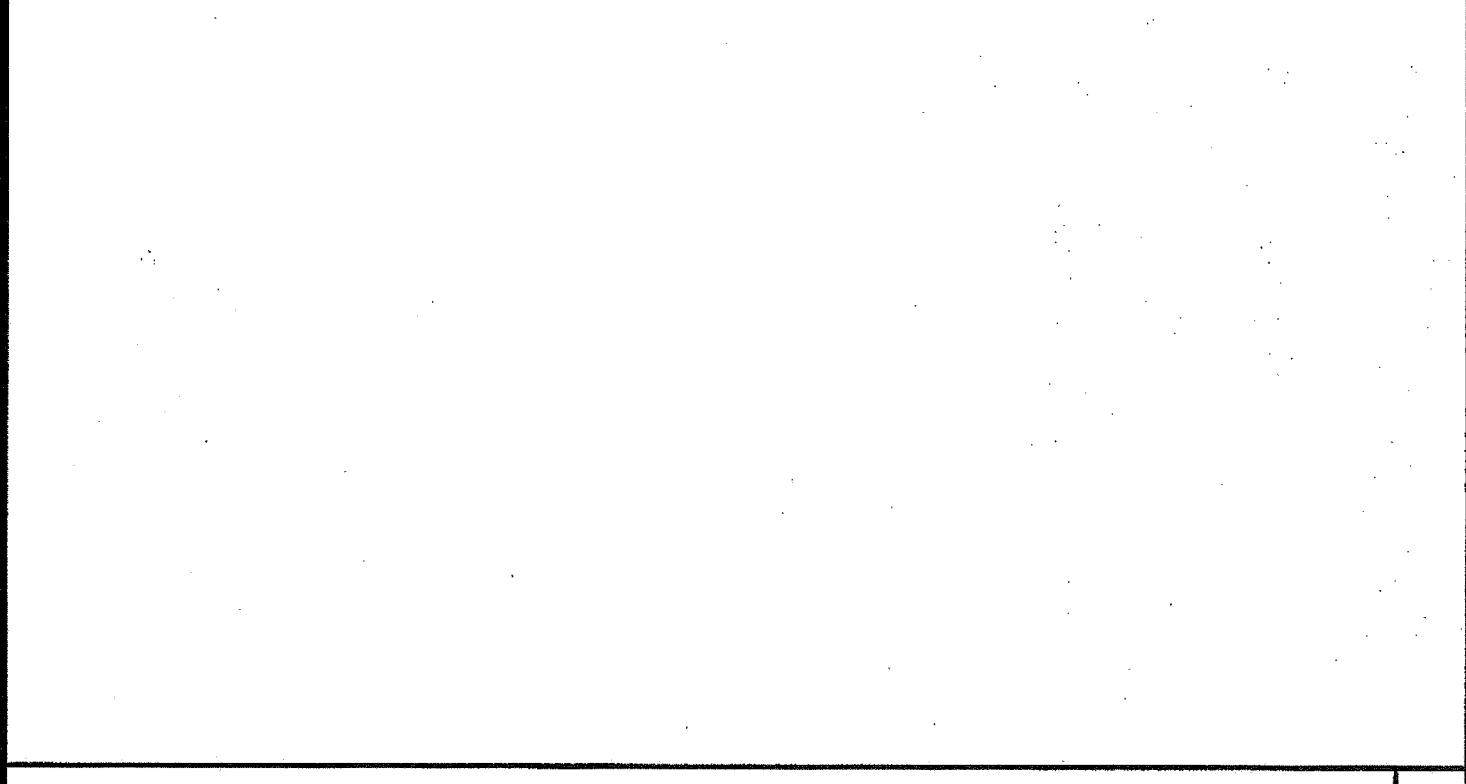

18 FOUNDATION AT MODLINE & SEPARATION SCALE: 1 1/2"=1'-0"

8 FOUNDATION AT MODLINE SCALE: 3"=1'-0"

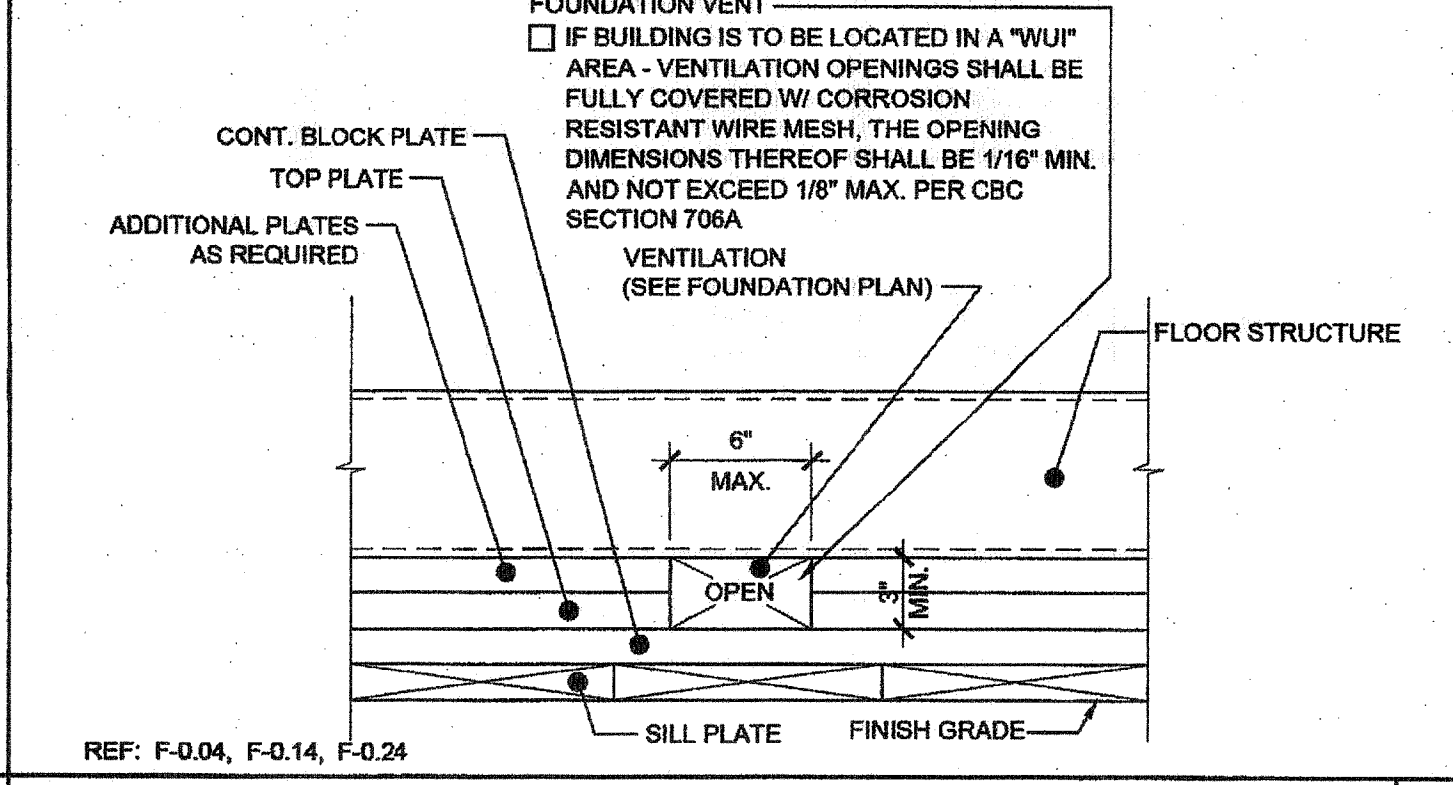
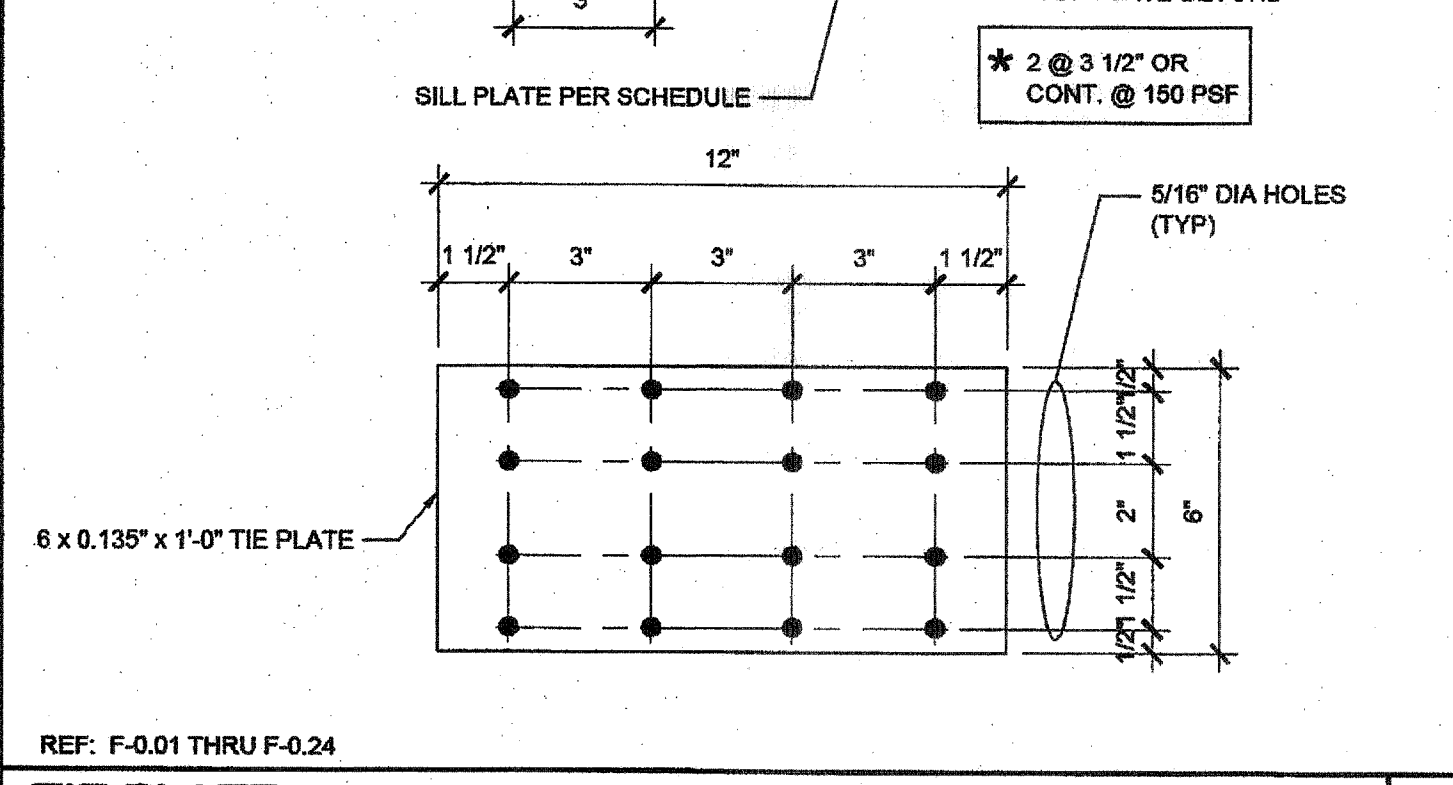
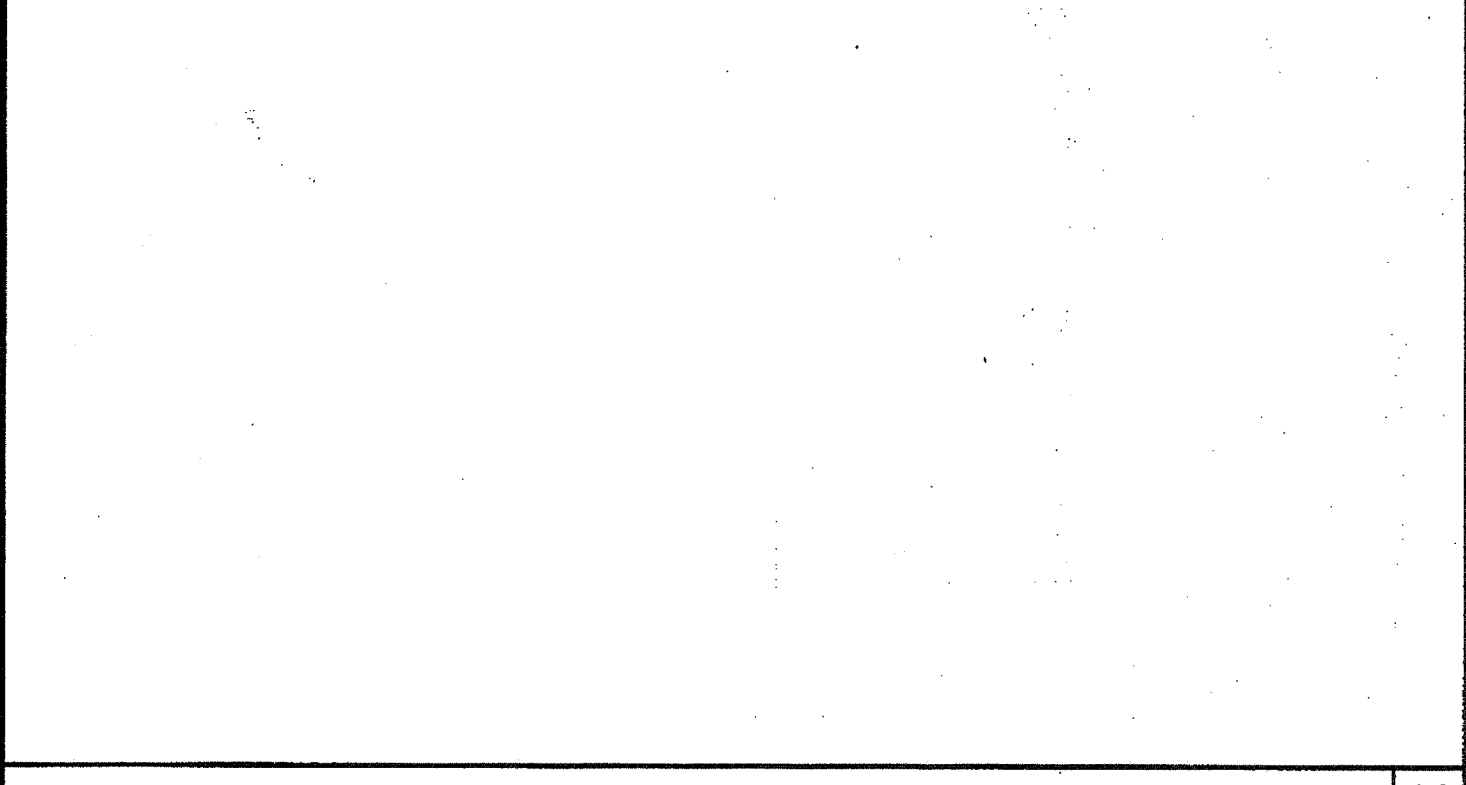

19 TIE PLATE SCALE: 3"=1'-0"

14 VENT ELEV. AT MODLINE & SEP FOR 150 PSF SCALE: 3"=1'-0"

9 FOUNDATION AT ADJACENT BUILDING SCALE: 3"=1'-0"

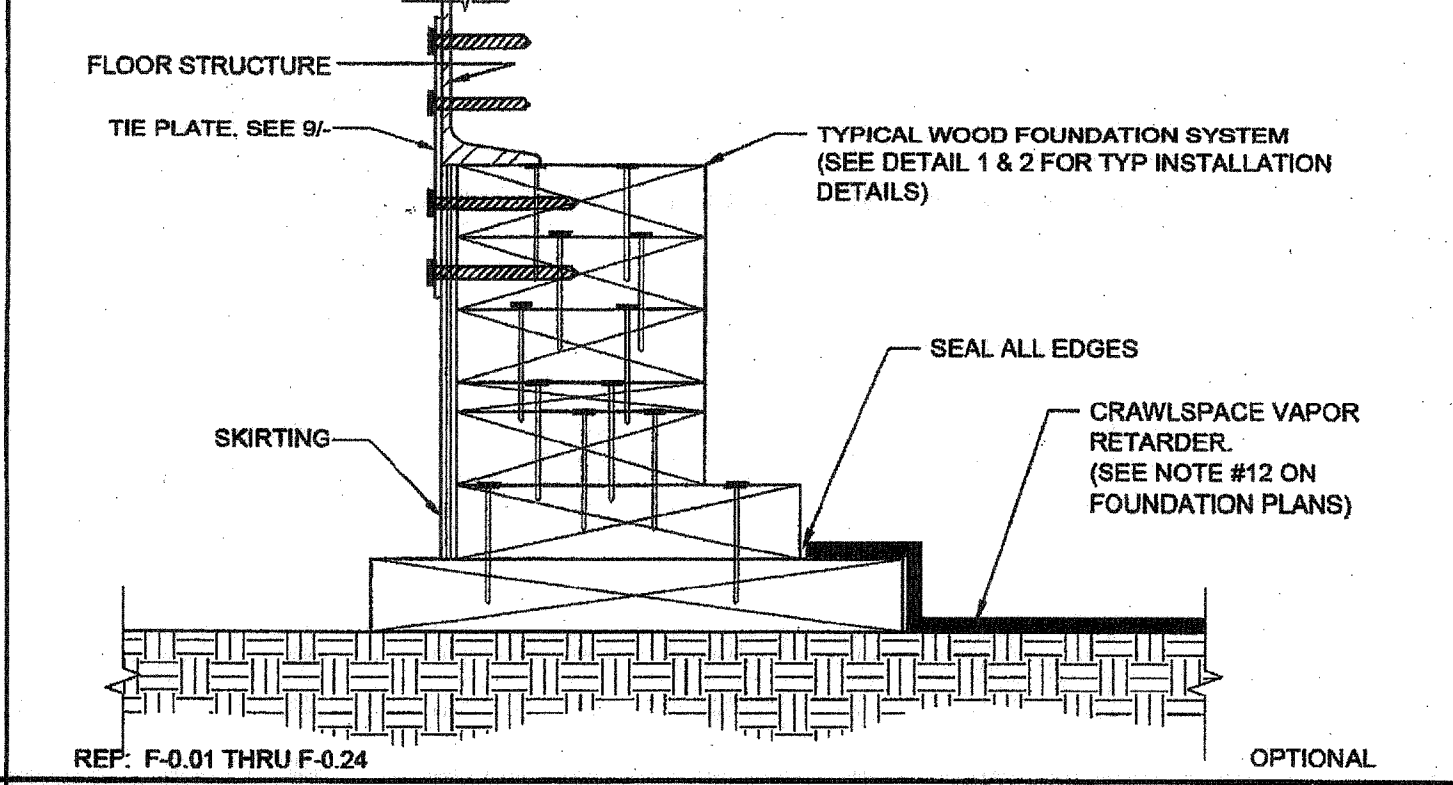
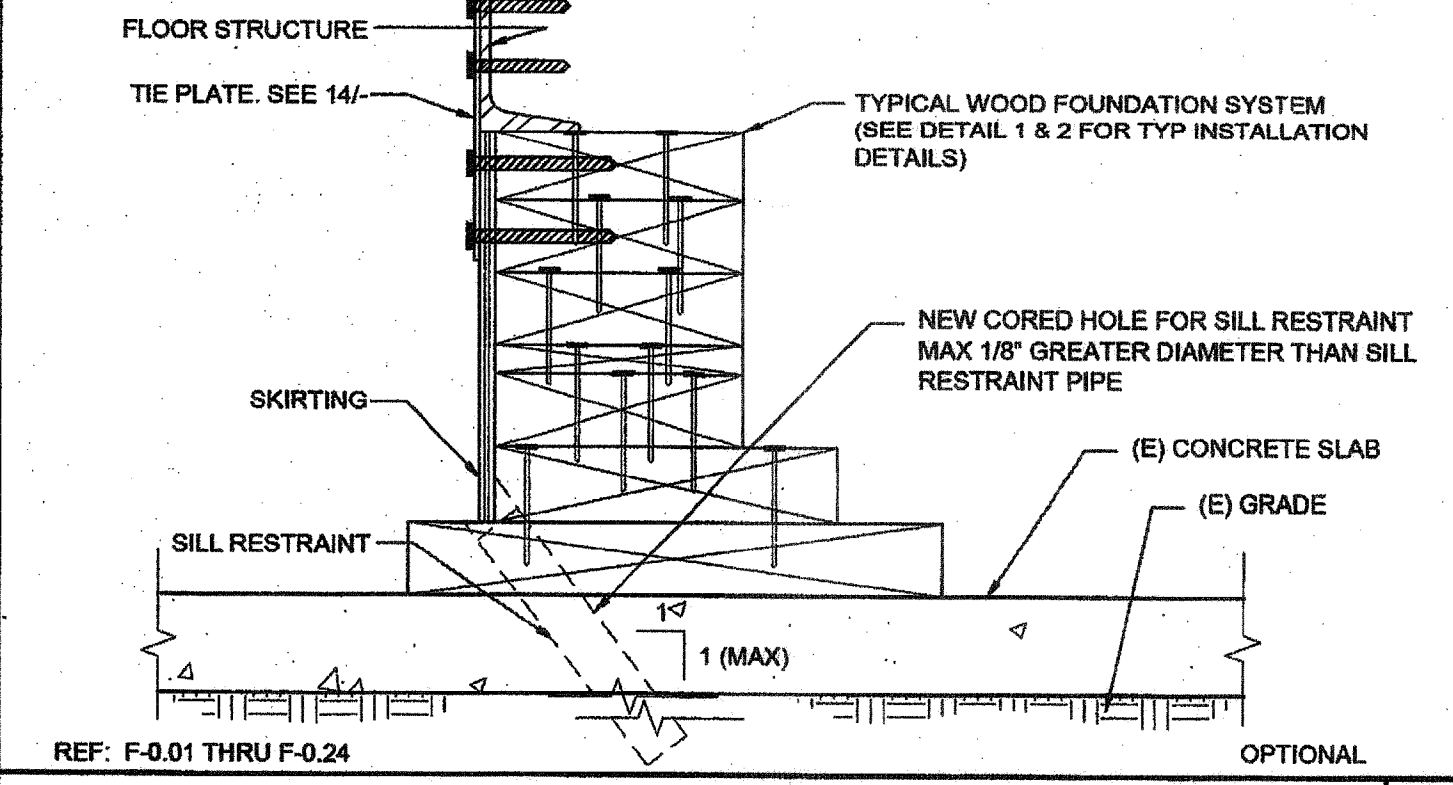
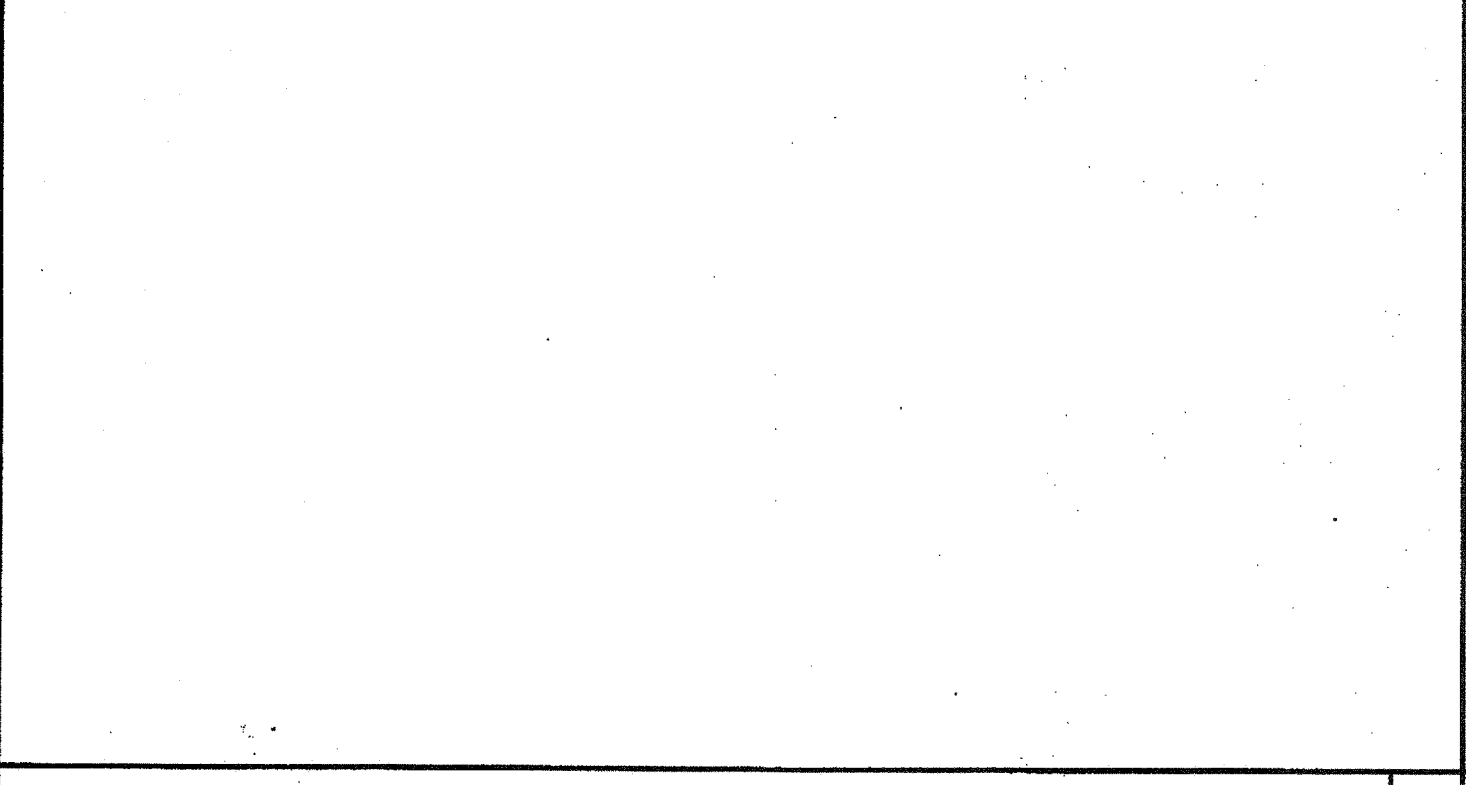

20 FOUNDATION ANCHORAGE AT CONCRETE PAD SCALE: 3"=1'-0"

15 CRAWLSPACE VAPOR RETARDER SCALE: 3"=1'-0"

10 FOUNDATION SPLICE SCALE: NTS

THESE DRAWINGS AND ALL MATERIAL CONTAINED HEREIN ARE THE PROPERTY OF SILVERCREEK INDUSTRIES, INC (SCI Inc) AND SHALL NOT BE REPRODUCED, COPIED OR OTHERWISE DISPOSED OF DIRECTLY OR INDIRECTLY AND SHALL NOT BE USED IN WHOLE OR IN PART TO ASSIST IN THE MAKING OF OR FOR THE PURPOSE OF FURNISHING ANY INFORMATION FOR THE MAKING OF DRAWINGS, PRINTS, APPARATUS OR PARTS THEREOF WITHOUT THE FULL KNOWLEDGE AND WRITTEN CONSENT OF SCI Inc. ALL PATENTABLE MATERIAL CONTAINED HEREIN AND ORIGINATING WITH SCI Inc SHALL BE THE PROPERTY OF SCI Inc.

SILVER CREEK INDUSTRIES, INC.
"BUILDING FOR THE NEXT GENERATION"

SILVER CREEK
2830 BARRETT AVE PERRIS, CALIFORNIA 92571
PHONE: 951-943-5393 FAX: 951-943-2211

PROJECT NAME:
24x40 STOCKPILE OFFICE BUILDING

SHEET TITLE:
FOUNDATION DETAILS WOOD

STAVARES ASSOCIATES
REGISTERED ARCHITECTS
15475 N. WILSHIRE BLVD. SUITE 202
DANA POINT, CA 92629
WWW.STAVARES.COM

LICENSED ARCHITECT
JACK F. SHIVELY III
No. C-33467
01-31-17
RENEWAL DATE

REGISTERED PROFESSIONAL FORESTER
D. F. FRIEDEL
No. S3380
STRUCTURAL
STATE OF CALIFORNIA
REF# 14217
06/15/15

ARCHITECT OF RECORD
SUBMISSION DATE
FILE # 15-6
IDENTIFICATION STAMP
DIV. OF THE STATE ARCHITECT
OFFICE OF REGULATION SERVICES
03-118270
AC. FLS. SS. RAE
DATE NOV - 8 2011
TRACKING #: 63221-290

PROJECT SPECIFIC STATE AGENCY APPROVAL
IDENTIFICATION STAMP
DIV. OF THE STATE ARCHITECT
OFFICE OF REGULATION SERVICES
04 118284
AC. FLS. SS. RAE
DATE MAY 18 2017

ORIGINAL PC STATE AGENCY APPROVAL
IDENTIFICATION STAMP
DIV. OF THE STATE ARCHITECT
OFFICE OF REGULATION SERVICES
PC 04-114102
AC. FLS. SS. RAE
DATE AUG - 4 2015

REVISIONS

SILVER CREEK INDUSTRIES
24' x 40' PC - 2:12 PITCH

PROJECT NO:
DRAWN BY:
SCALE: AS NOTED
DATE: 01-30-15
P.C. SHEET NUMBER

F-0.50