

Ownership of Documents
This document, the ideas and designs incorporated herein, as an instrument of Professional Service is the property of Integrated Designs by SOMAM Inc. and is not to be used, in whole or in part for any other project without written authorization.
© COPYRIGHT 2017

Integrated designs by SOMAM, Inc.
ARCHITECTURE - ENGINEERING - INTERIOR DESIGN - CONSTRUCTION MANAGEMENT
6011 N. Fresno, Suite 130 - Fresno, California 93710
Phone (559) 436-0881 Fax (559) 436-0887 E-Mail: design@somam.com
www.integrateddesigns.com

Rev. No.	Rev. Date	Revision Description

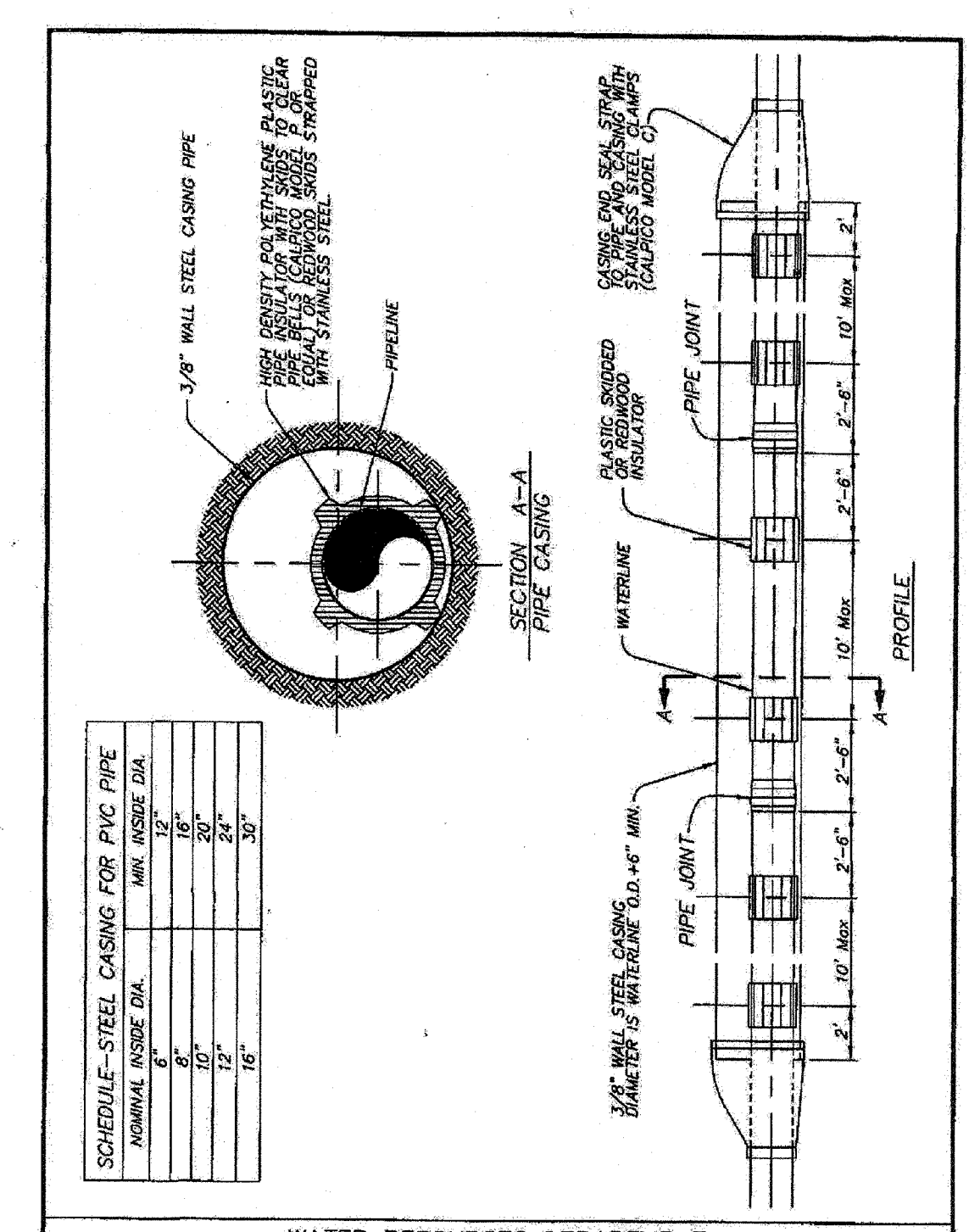
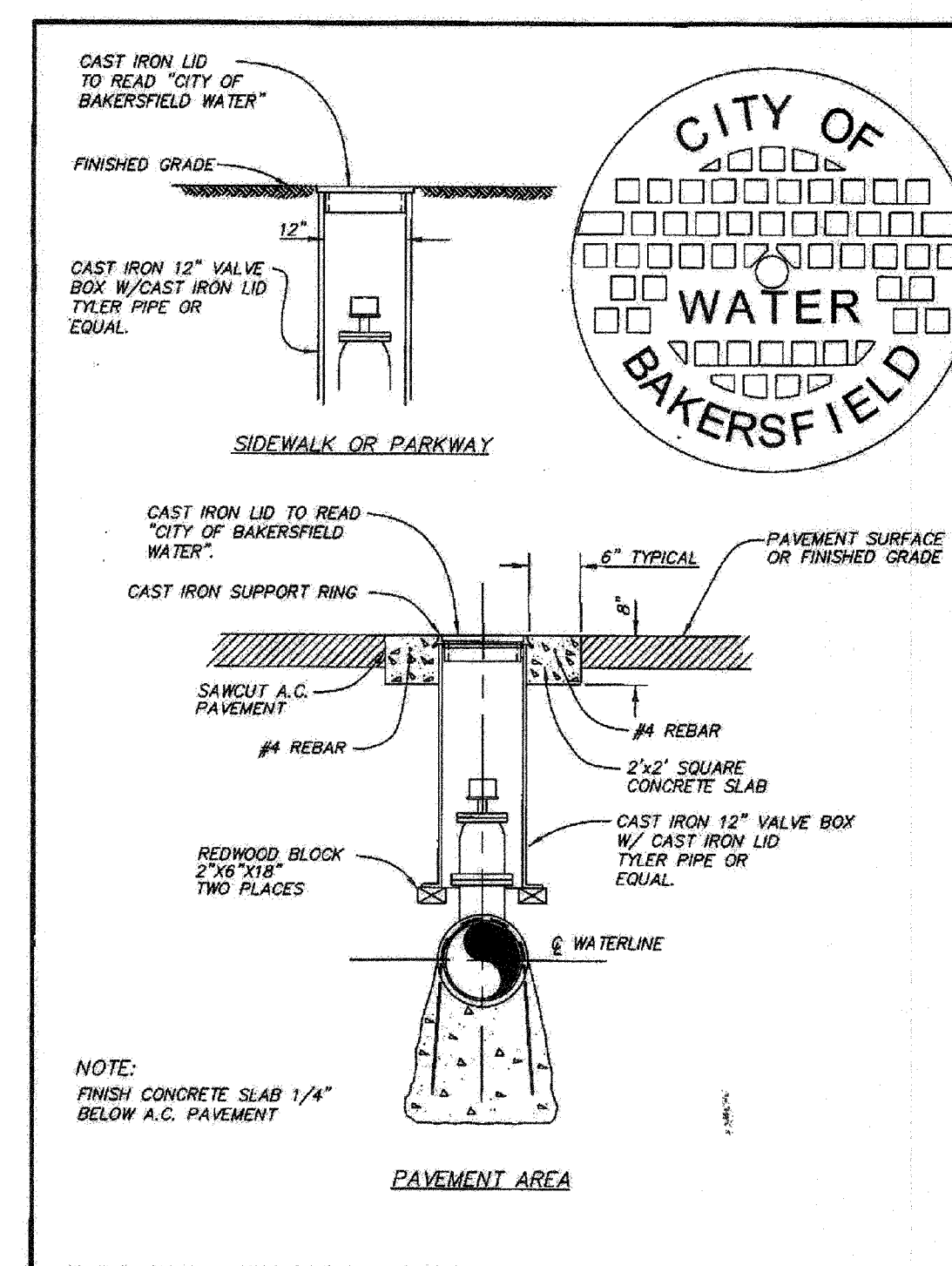
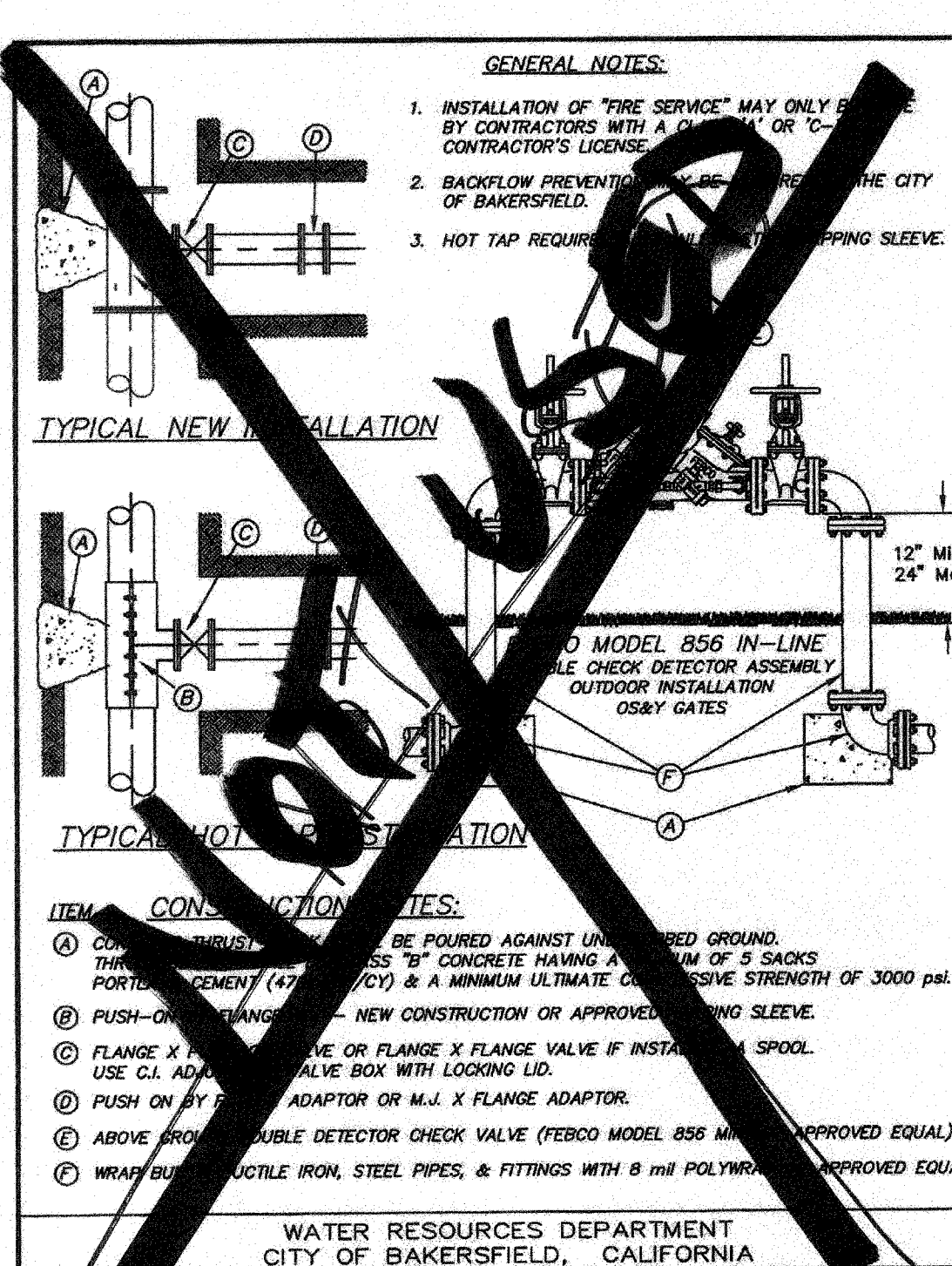
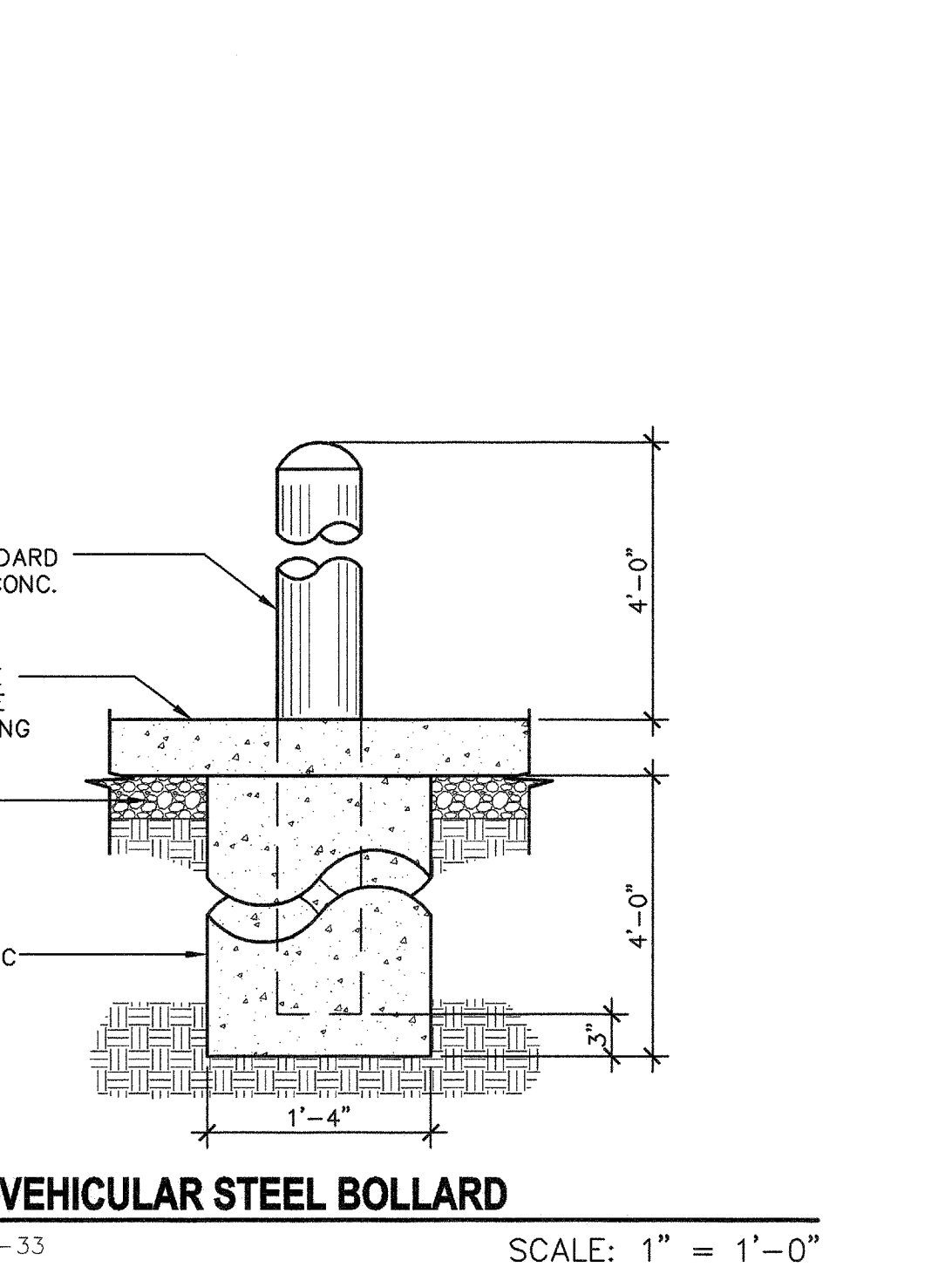

DETAILS

Sheet Title: **FREMONT ELEMENTARY PARKING LOT AND OFFICE PORTABLE**
BAKERSFIELD CITY SCHOOL DISTRICT
607 TEXAS ST. BAKERSFIELD, CA.

Issue Date: 07/30/17
Date: 10/10/17
Designer: [Signature]
DR: [Signature]
PC: RJD

Agency Approval Stamp:
FILE # 15-6
IDENTIFICATION STAMP
DIV. OF THE STATE ARCHITECT
OFFICE OF REGULATION SERVICES
03-118270
AC: FLS, HSS, CL
DATE: NOV 8 2017
TRACKING #: 63221-290

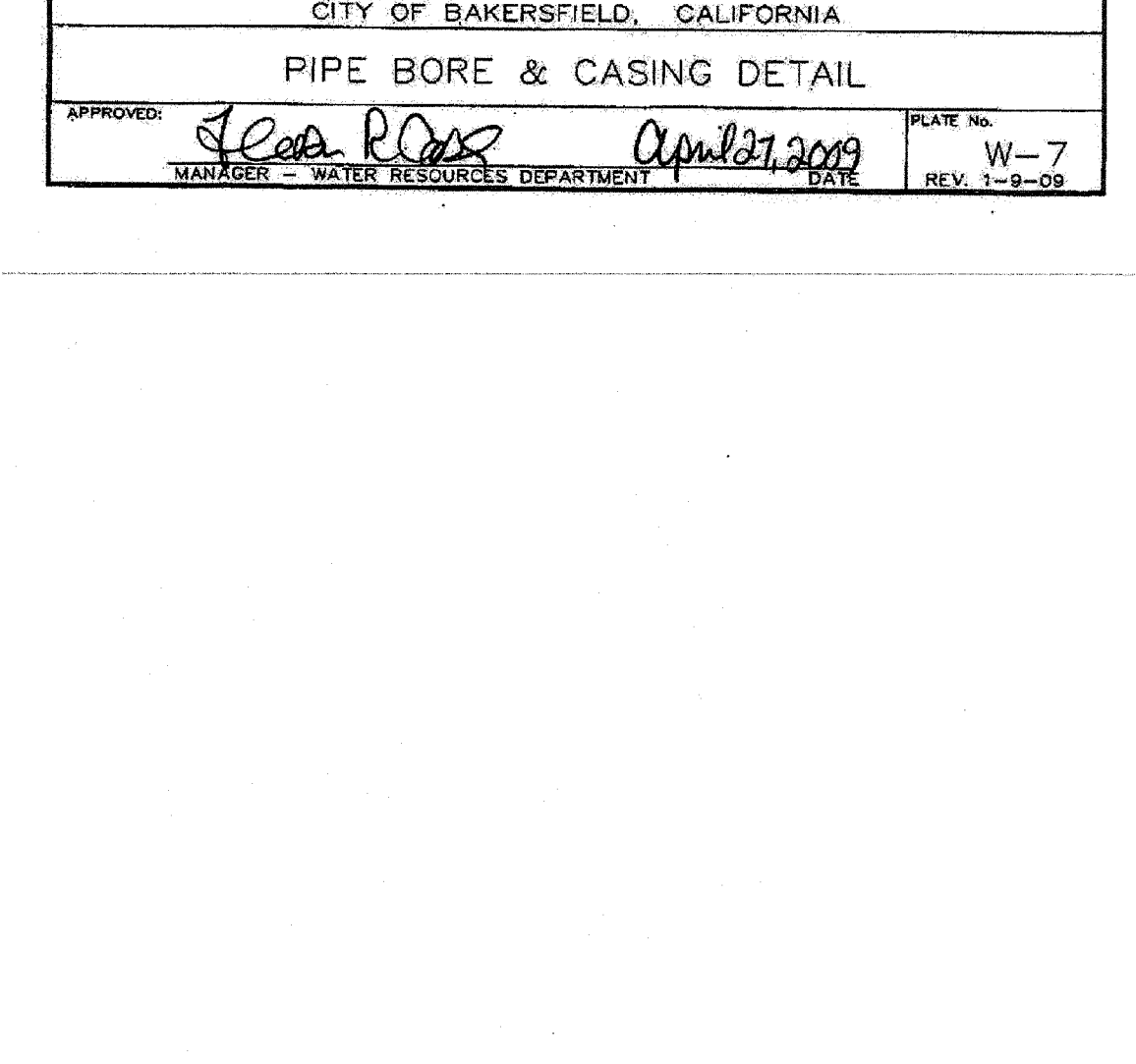
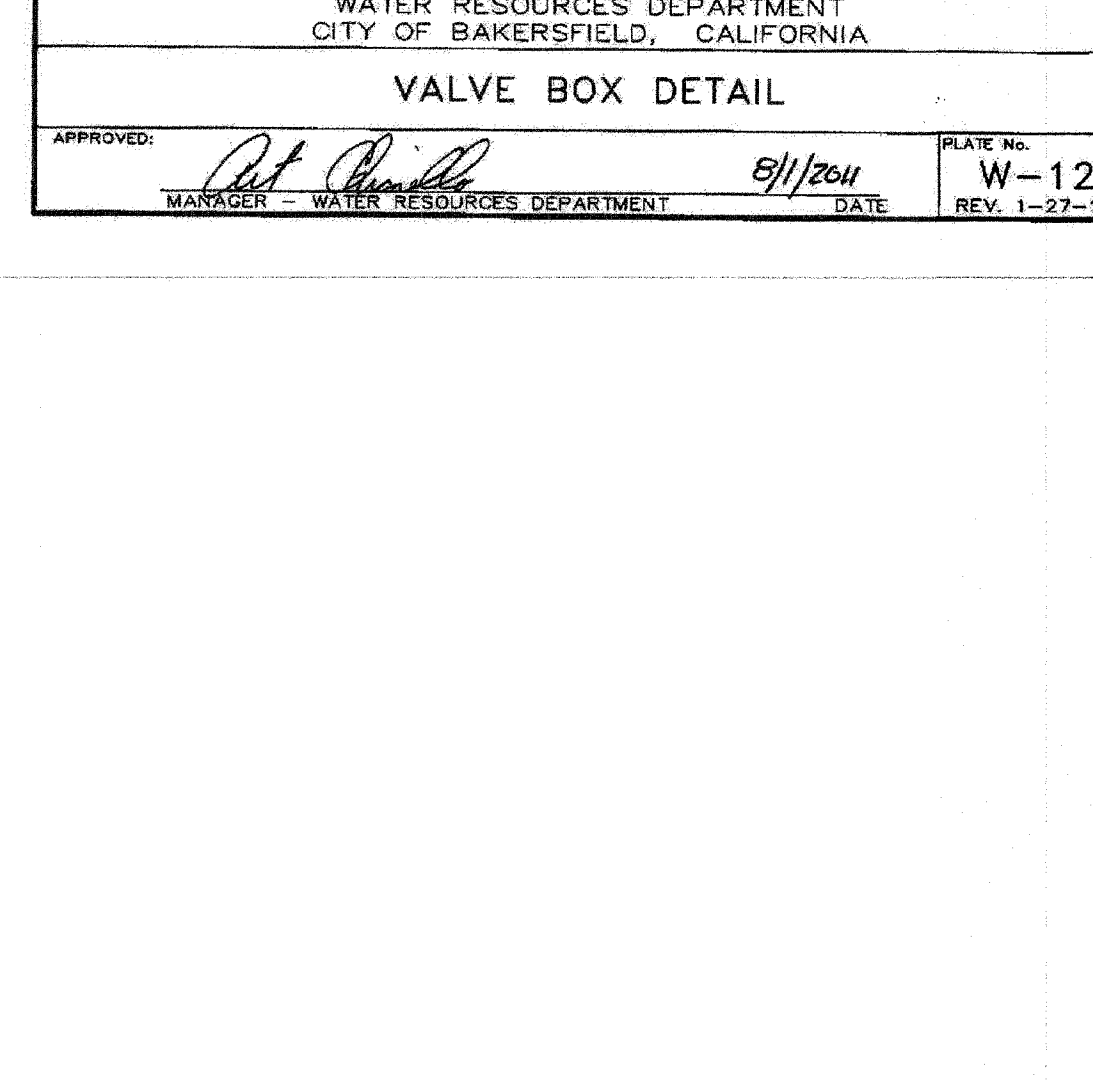
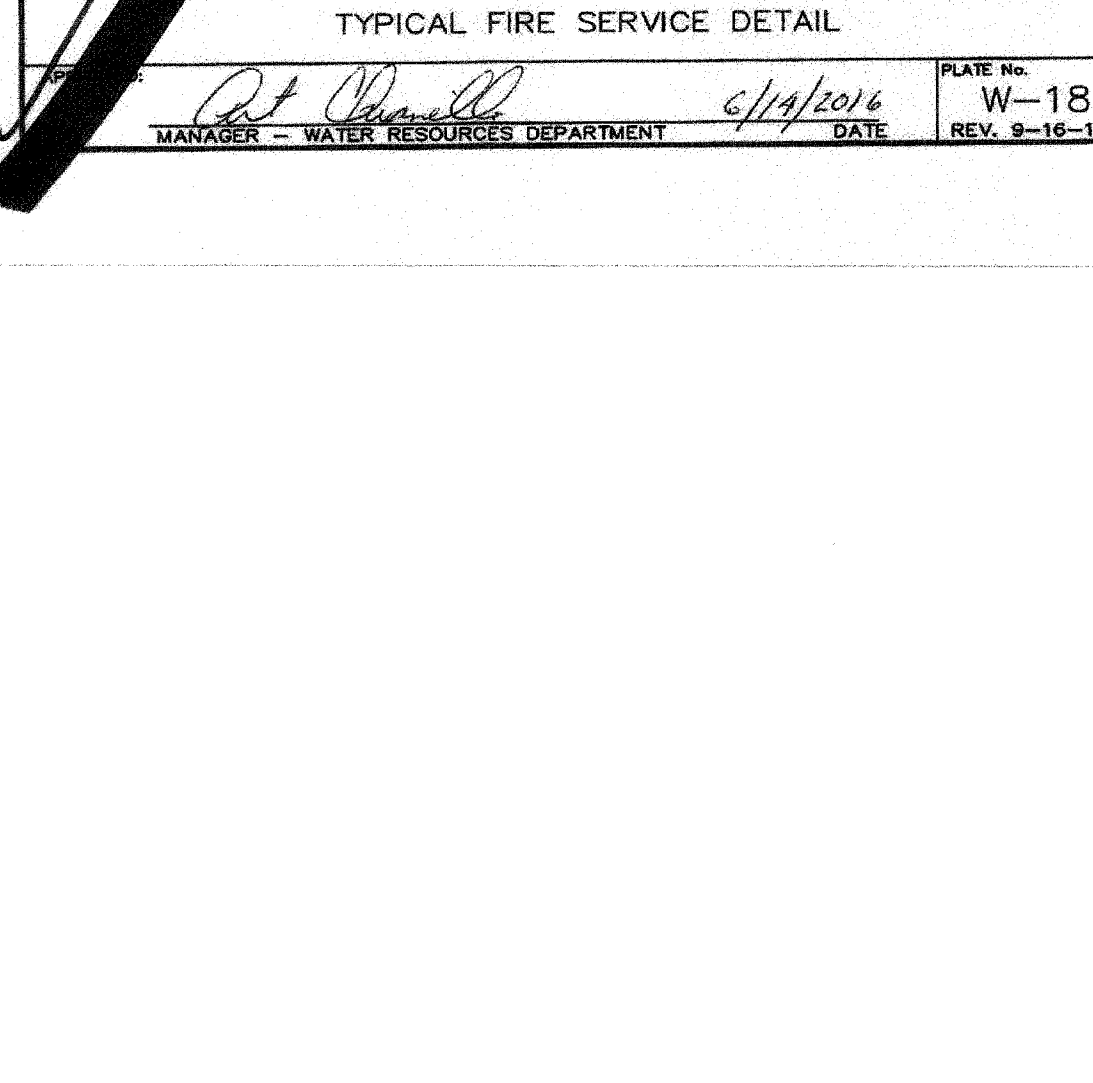

DETAILS

Sheet Title: **FREMONT ELEMENTARY PARKING LOT AND OFFICE PORTABLE**
BAKERSFIELD CITY SCHOOL DISTRICT
607 TEXAS ST. BAKERSFIELD, CA.

Issue Date: 07/30/17
Date: 10/10/17
Designer: [Signature]
DR: [Signature]
PC: RJD

Agency Approval Stamp:
FILE # 15-6
IDENTIFICATION STAMP
DIV. OF THE STATE ARCHITECT
OFFICE OF REGULATION SERVICES
03-118270
AC: FLS, HSS, CL
DATE: NOV 8 2017
TRACKING #: 63221-290

Stamp(s):

Job No.: **5269**

Sheet No.: **A1.04**

Release: -