

1 WHEEL STOP
SCALE: 1/2" = 1'-0"

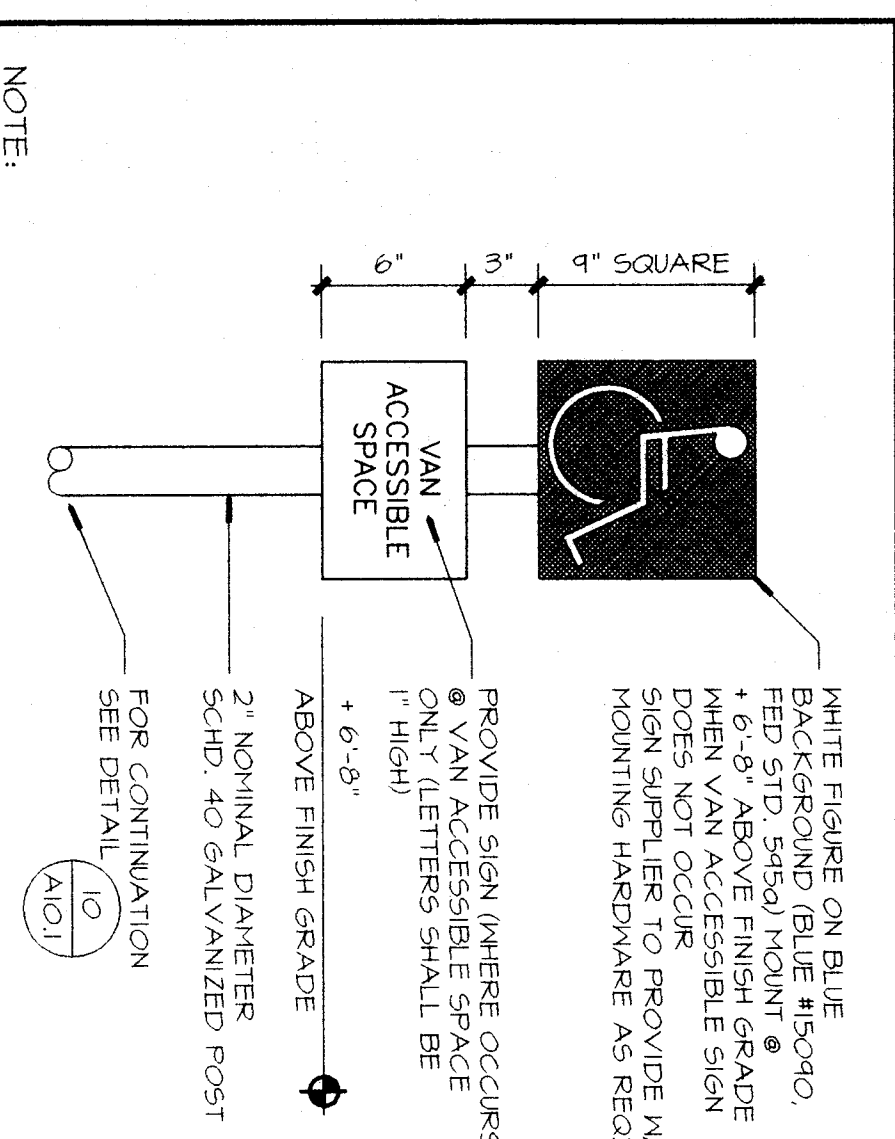

2 CONCRETE WALK
SCALE: 1/2" = 1'-0"

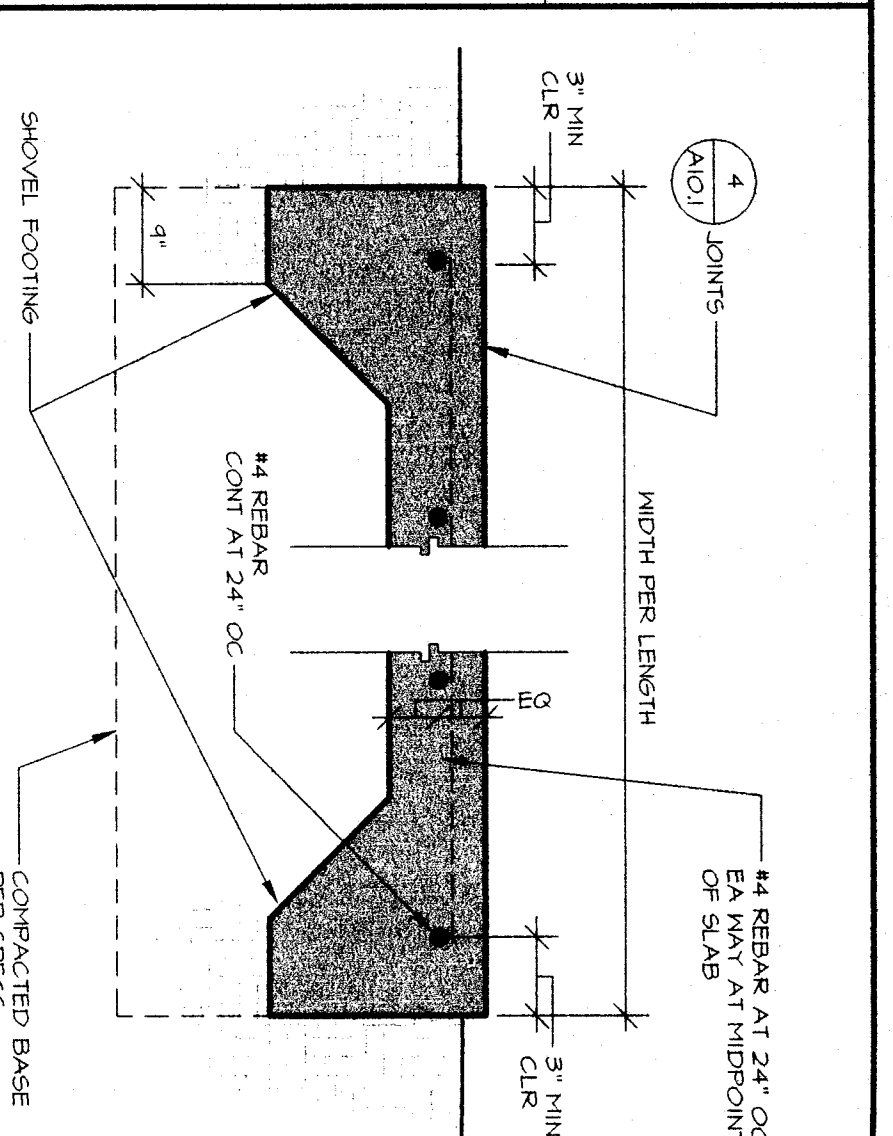

3 CONCRETE WALK TO (E)
SCALE: 1/2" = 1'-0"

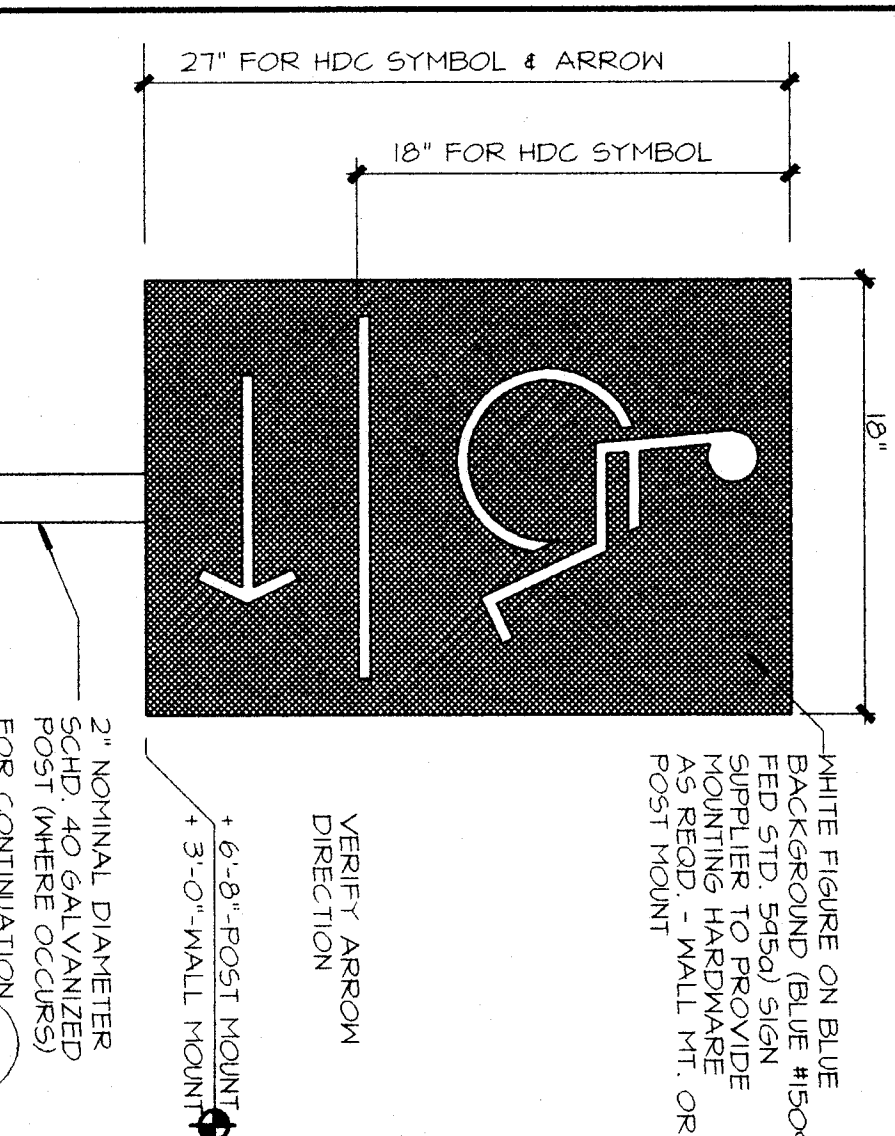

9 AUTHORIZATION SIGN
SCALE: 1/2" = 1'-0"

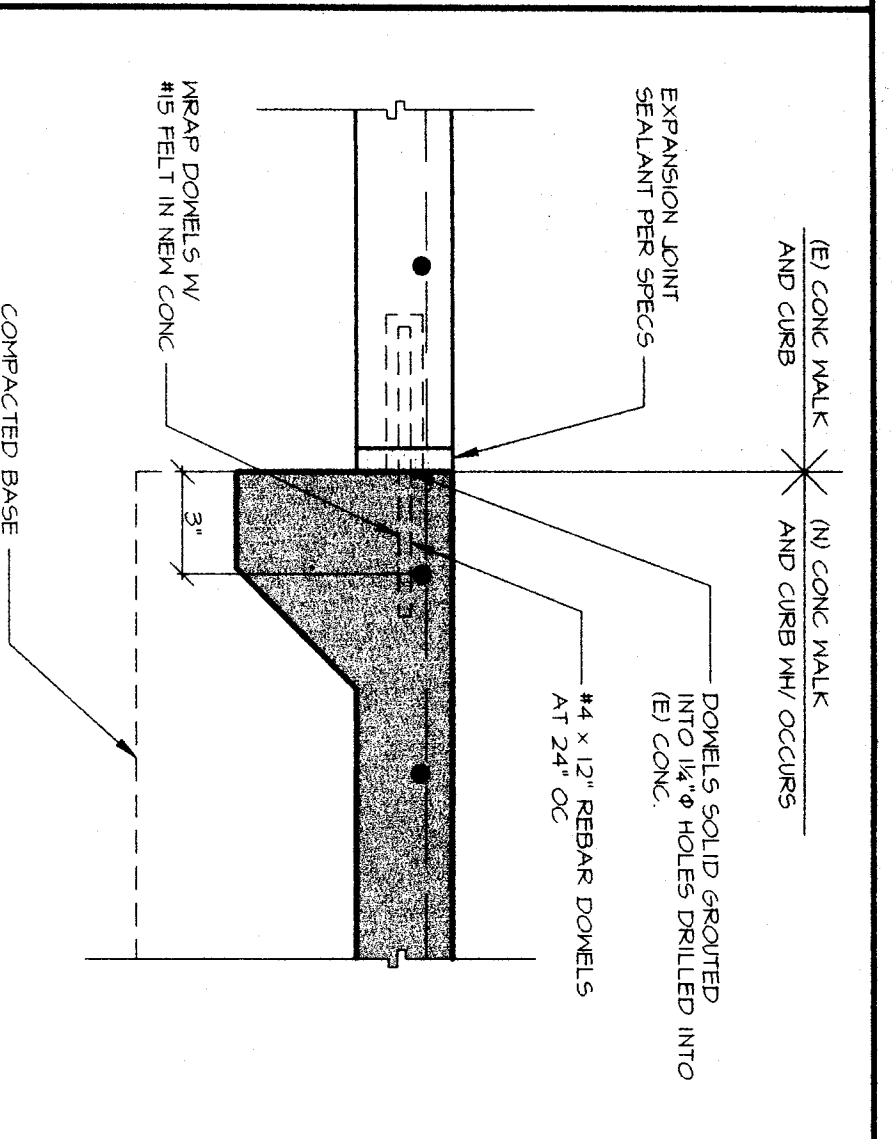

4 TYPICAL CONCRETE JOINTS
SCALE: 1/2" = 1'-0"

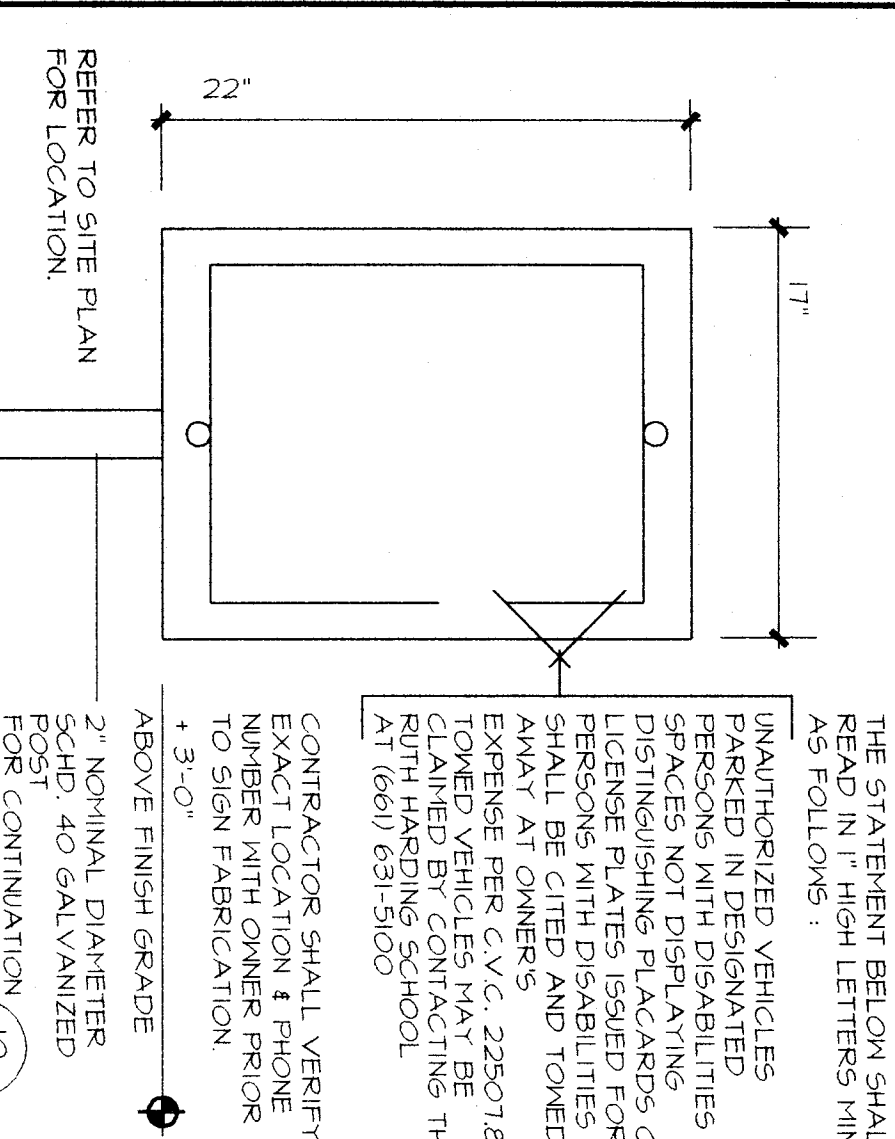

10 POST FTG DETAIL
SCALE: 1/2" = 1'-0"

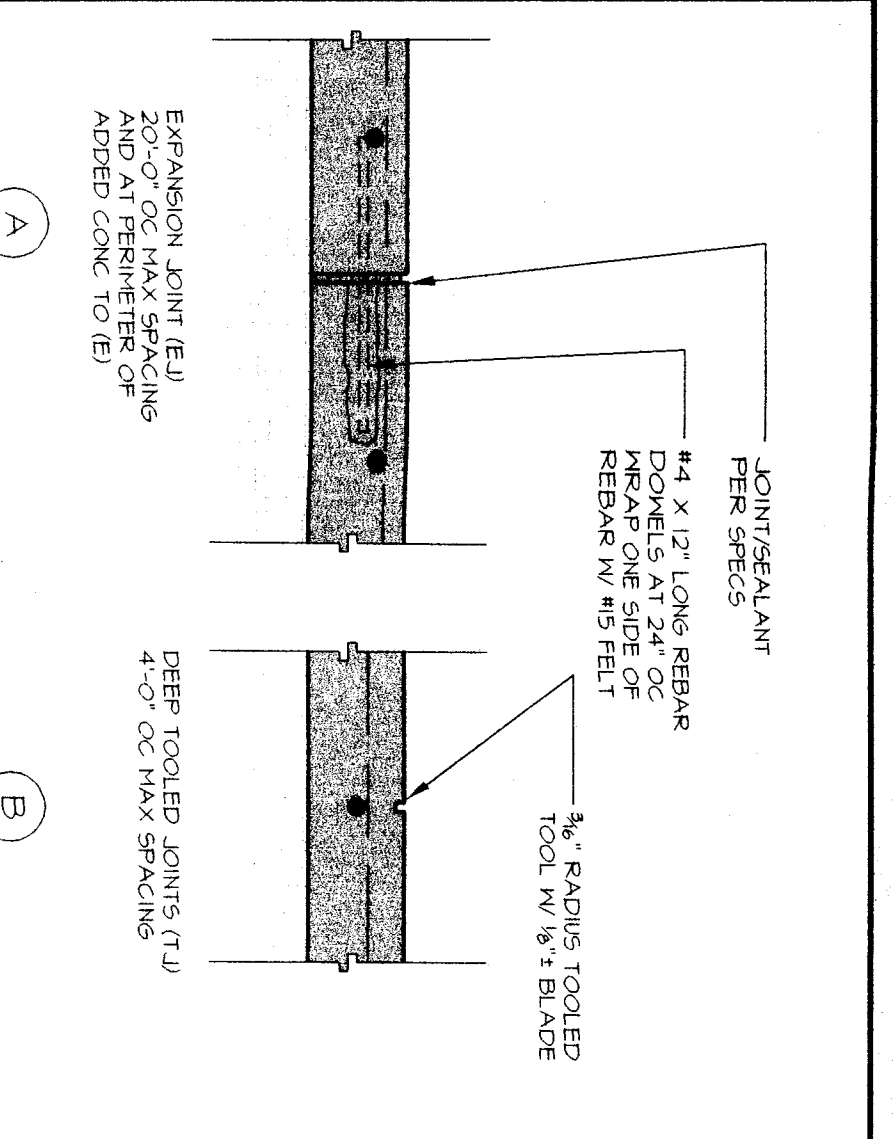

11 T-BAR GRID
SCALE: 1/2" = 1'-0"

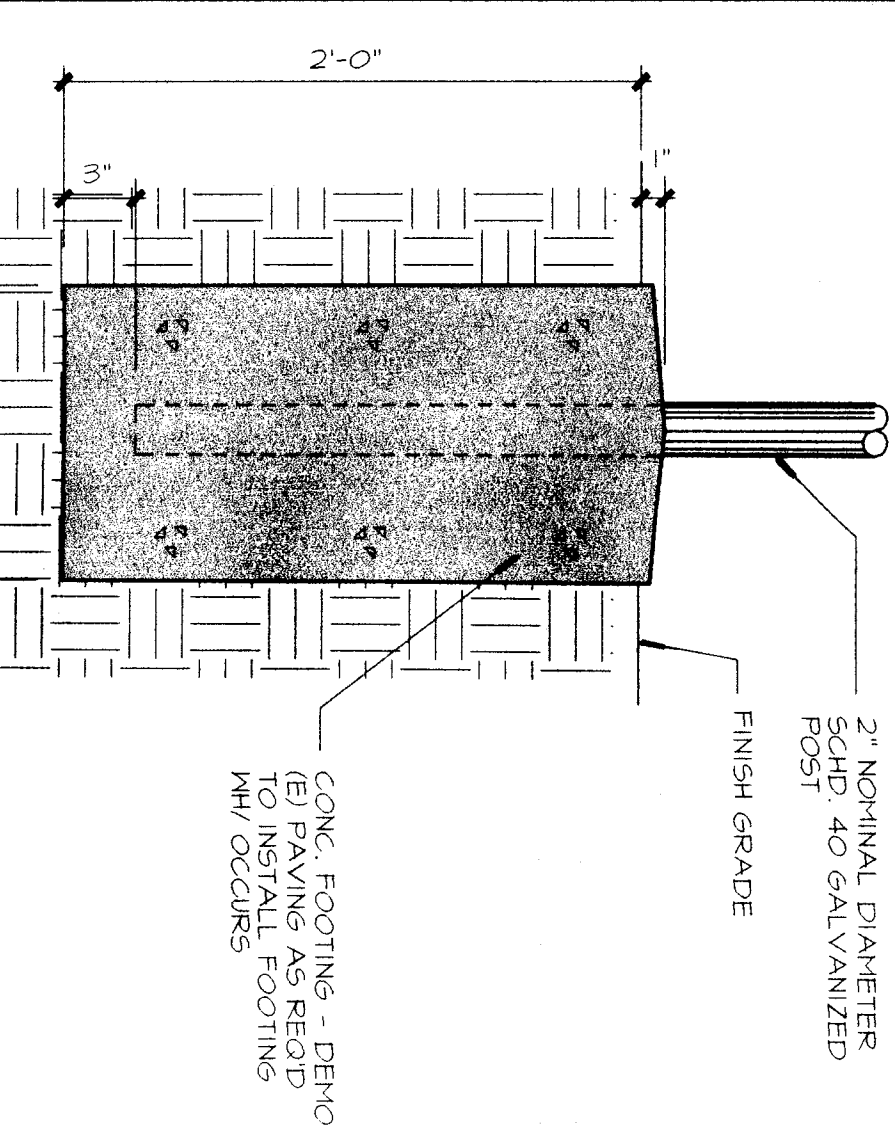

12 T-BAR FREE END
SCALE: 1/2" = 1'-0"

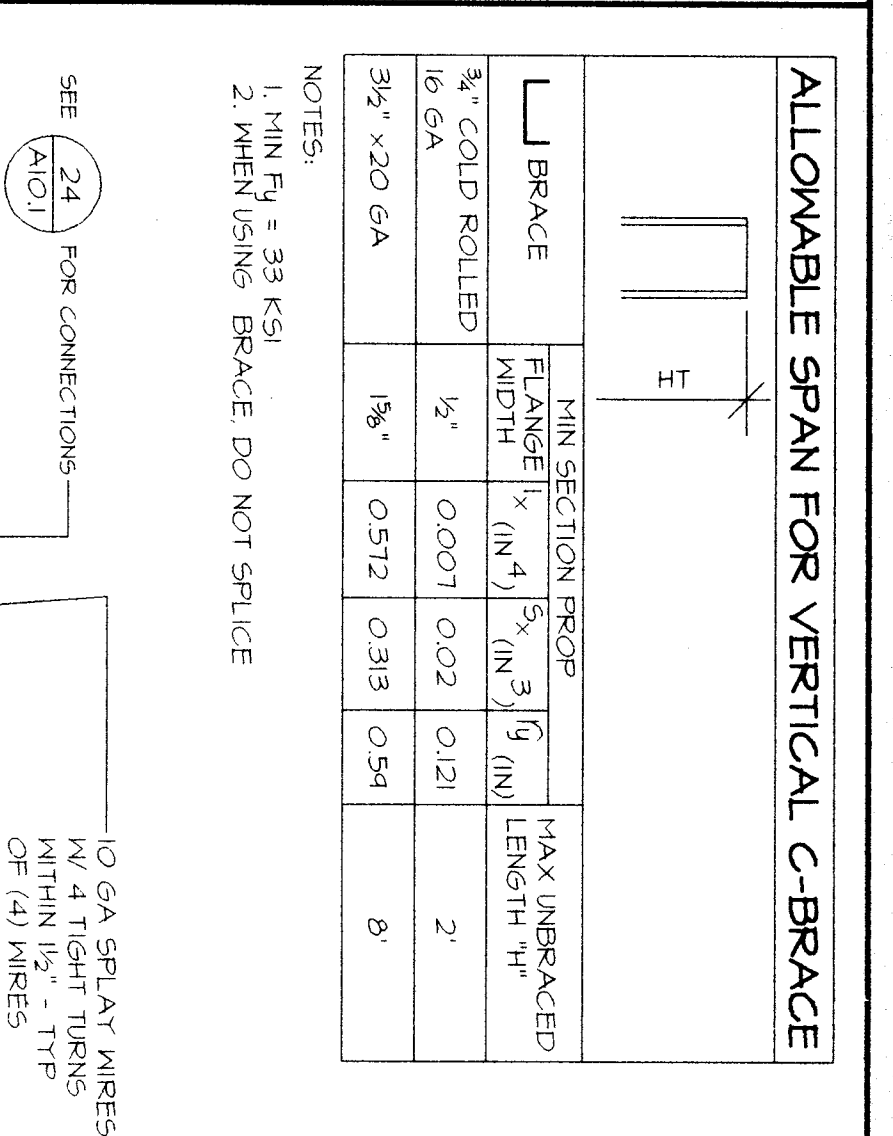

6 T-BAR FIXED END
SCALE: 1/2" = 1'-0"

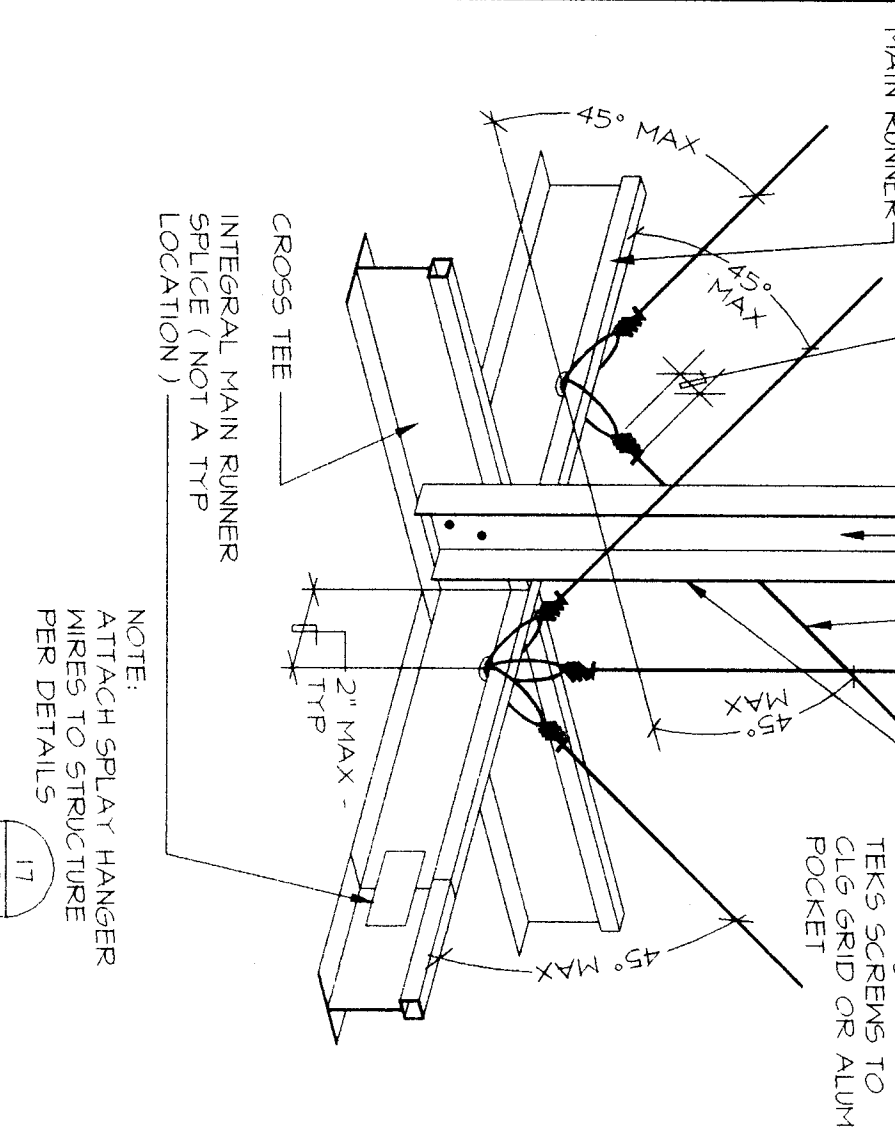

24 STUD CHANNEL TO ROOF FRMG
SCALE: 1/2" = 1'-0"

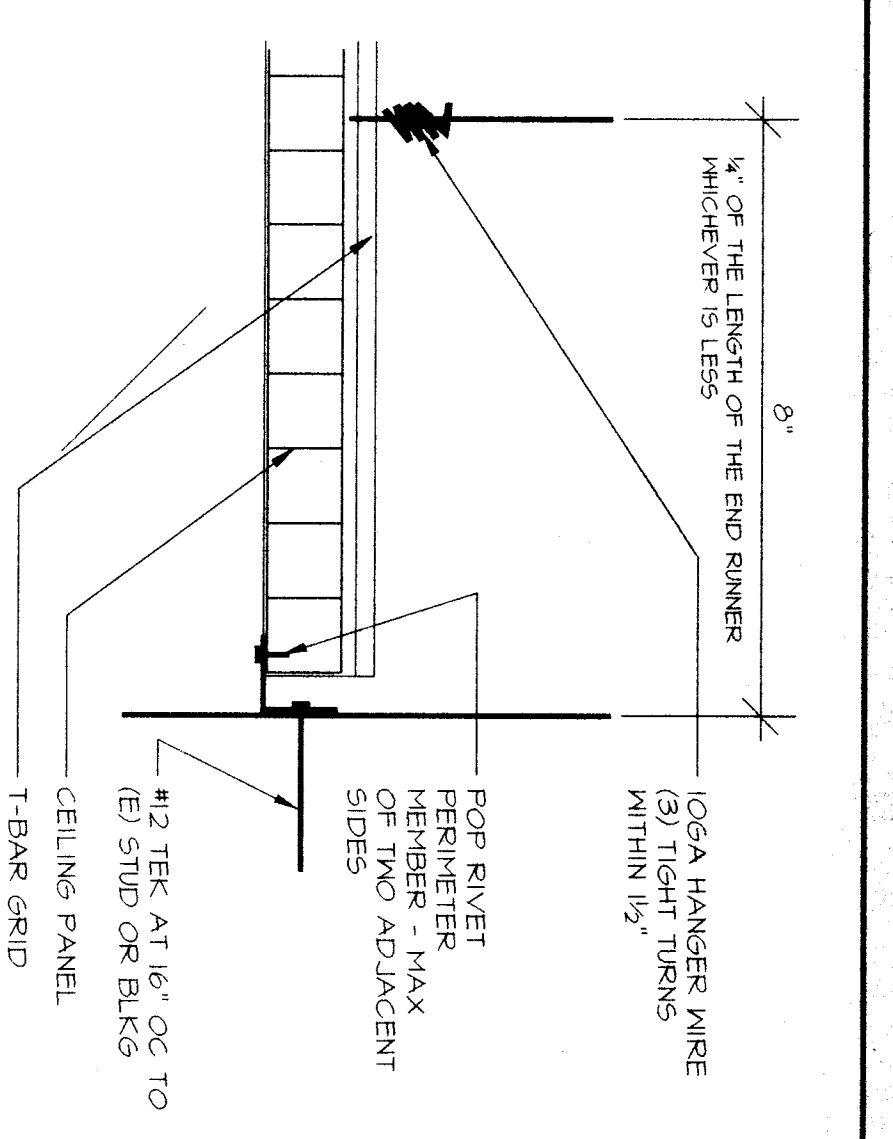

17 SPLAY HANGER WIRE
SCALE: 1/2" = 1'-0"

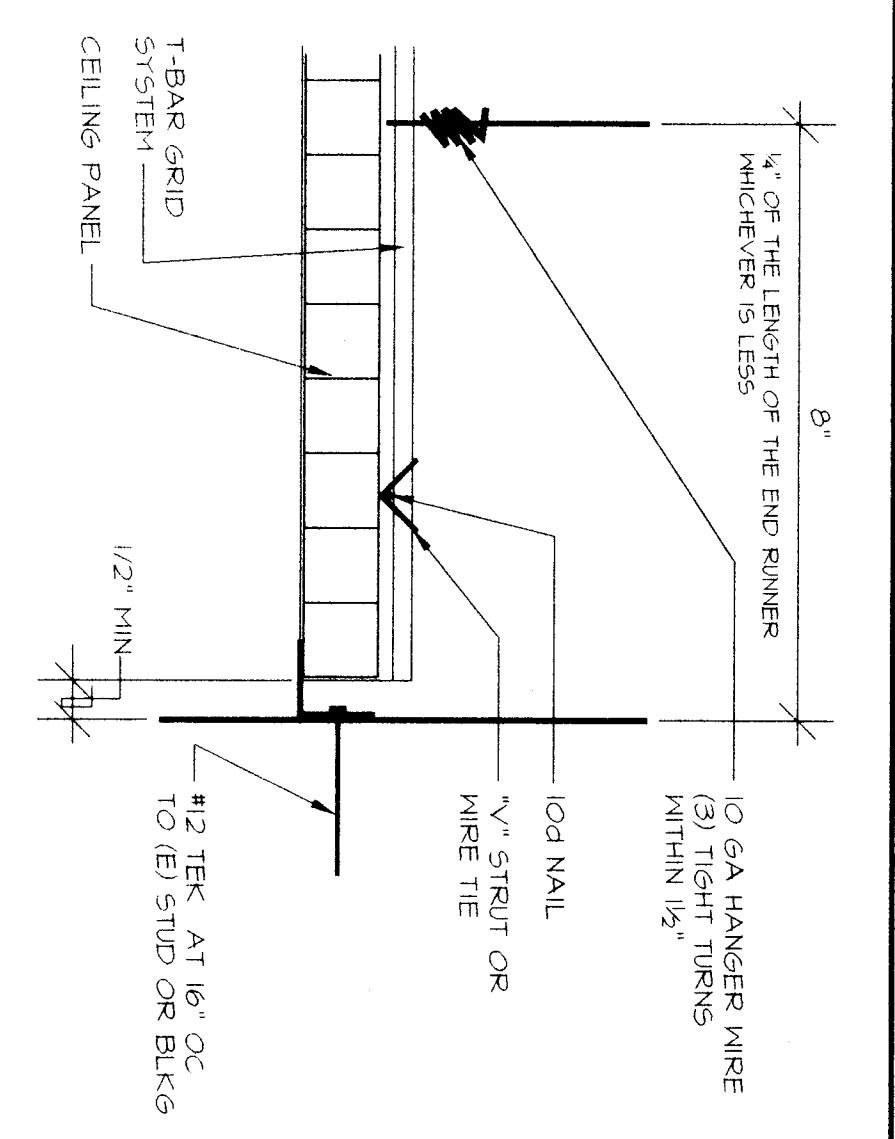

22 MAGAZINE RACK
SCALE: 1/2" = 1'-0"

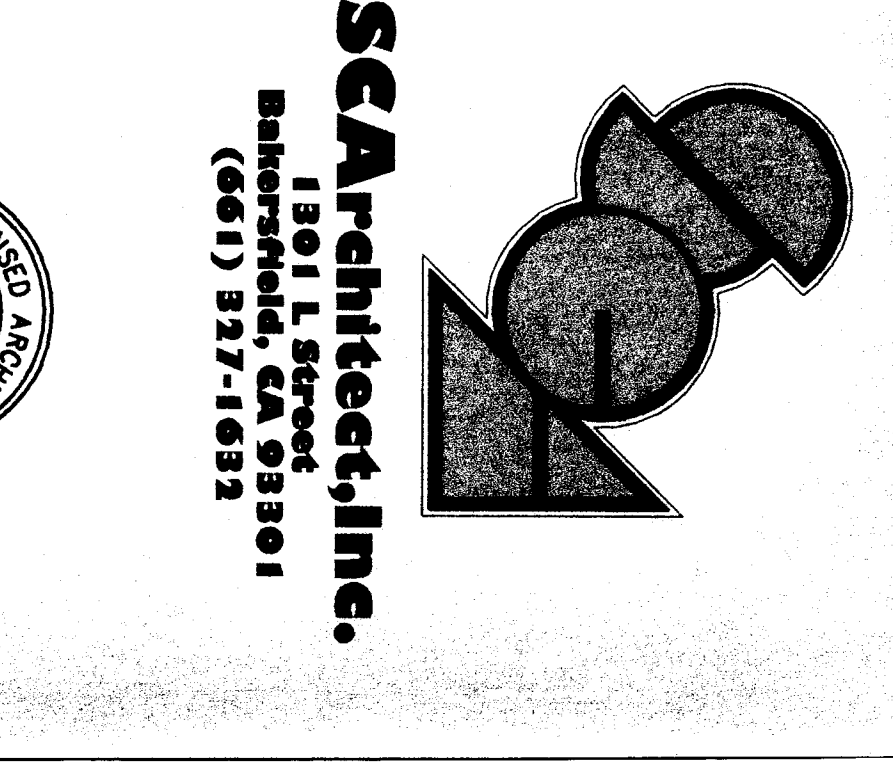

29 TOILET PARTITION
SCALE: 1/2" = 1'-0"

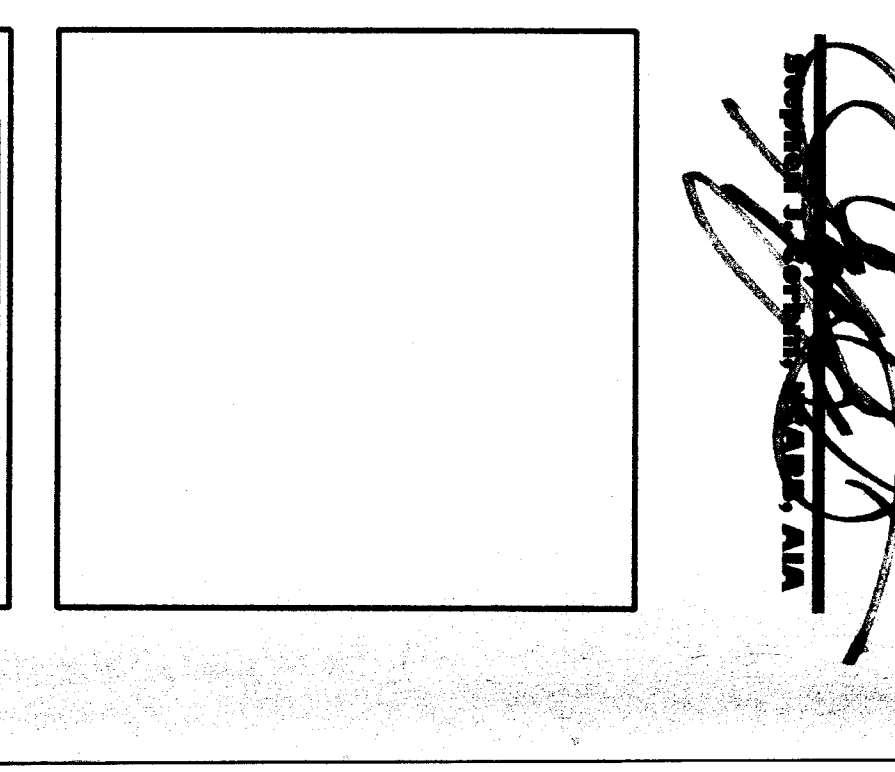

30 REQD FLR CLEARANCES
SCALE: 1/2" = 1'-0"

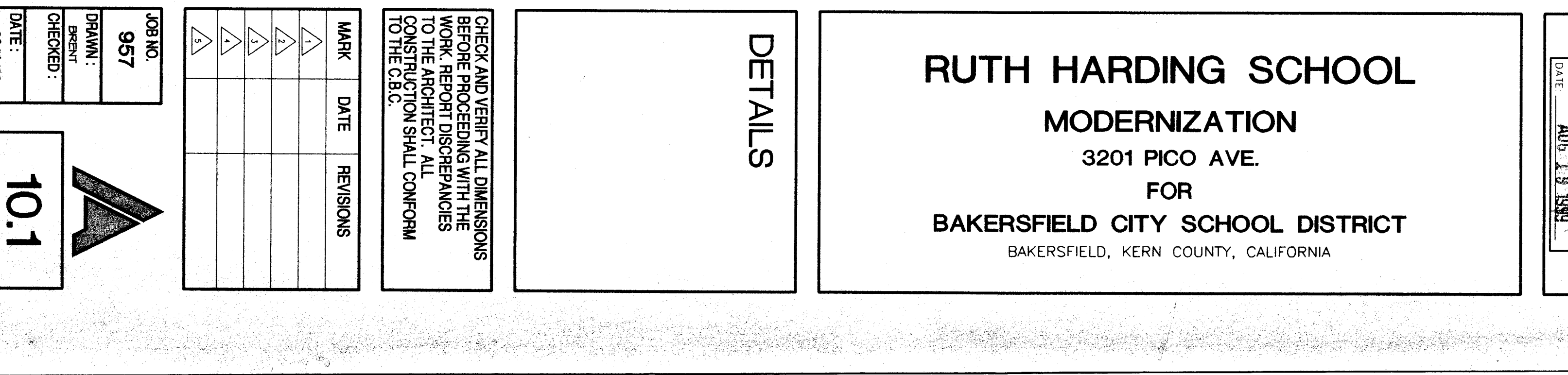
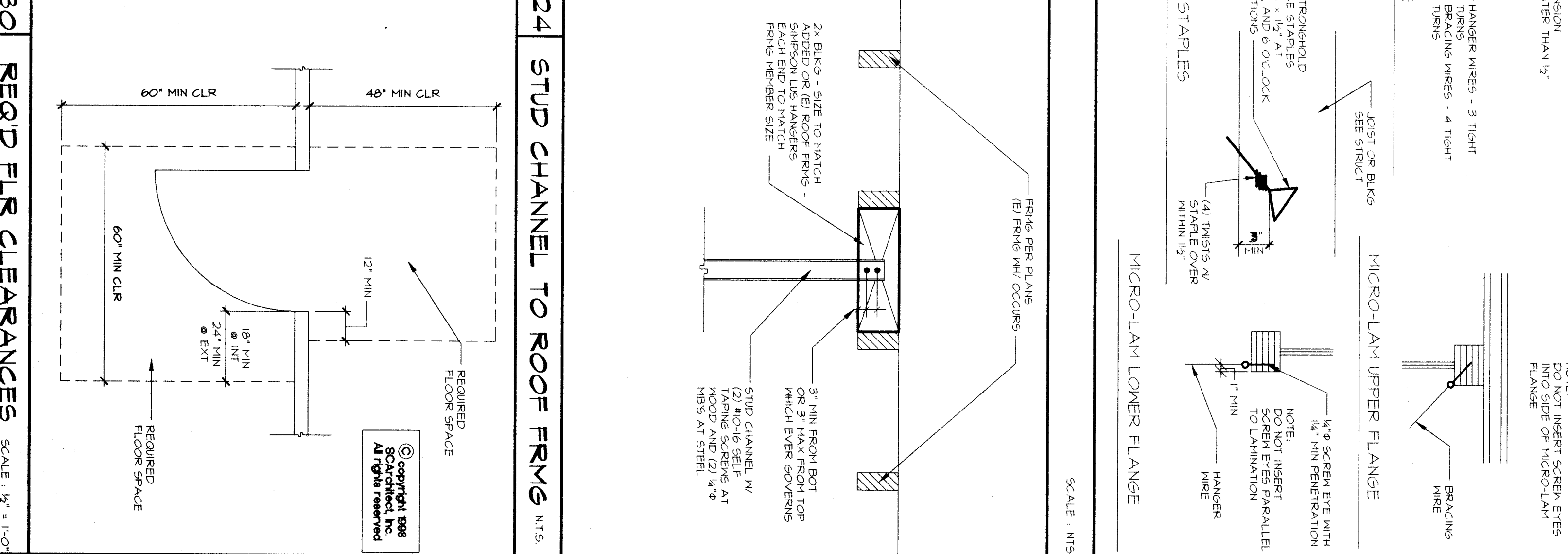
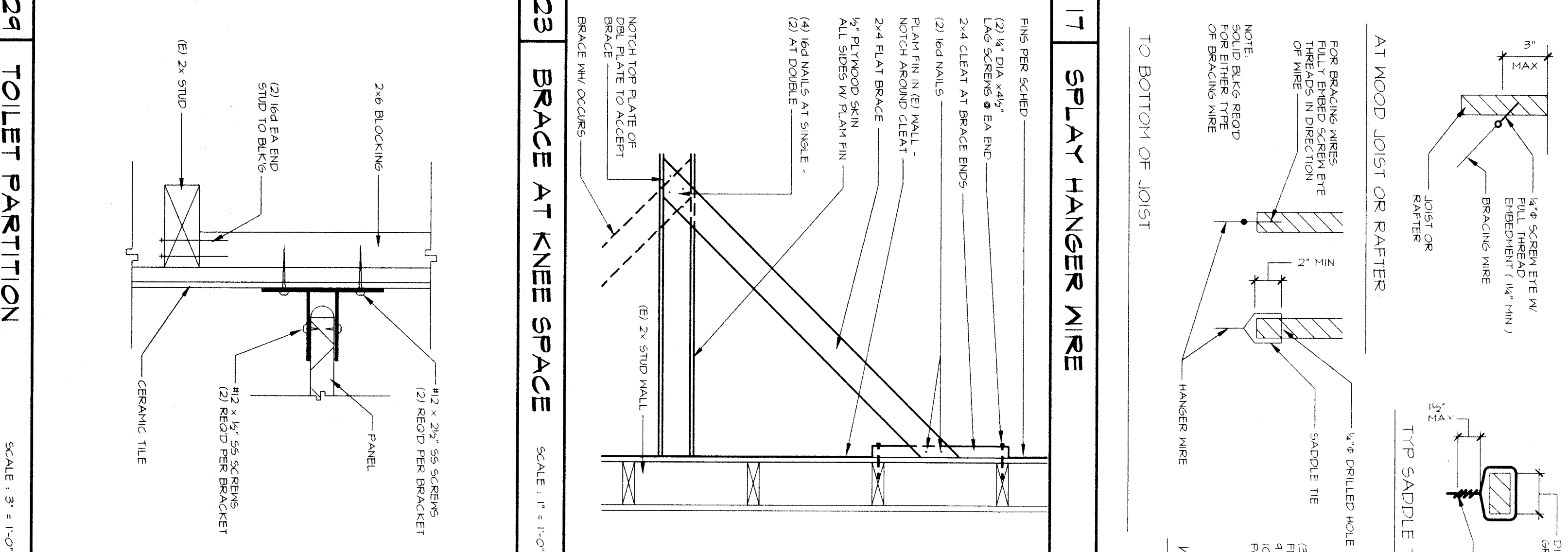
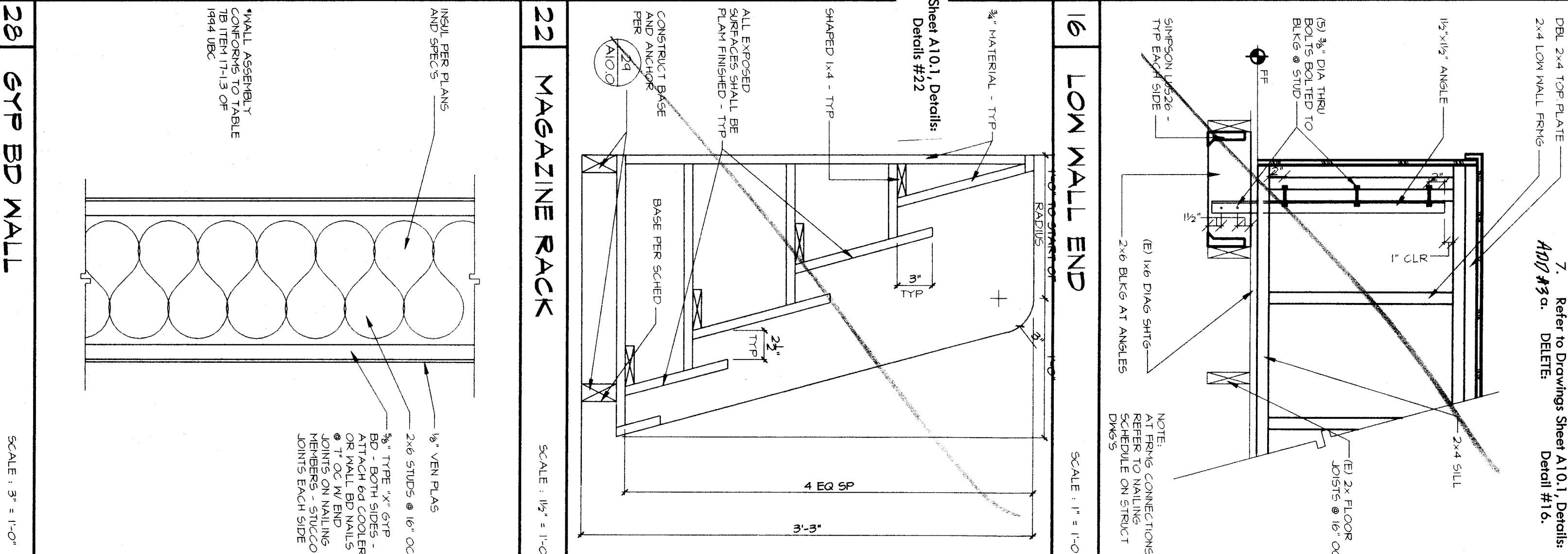
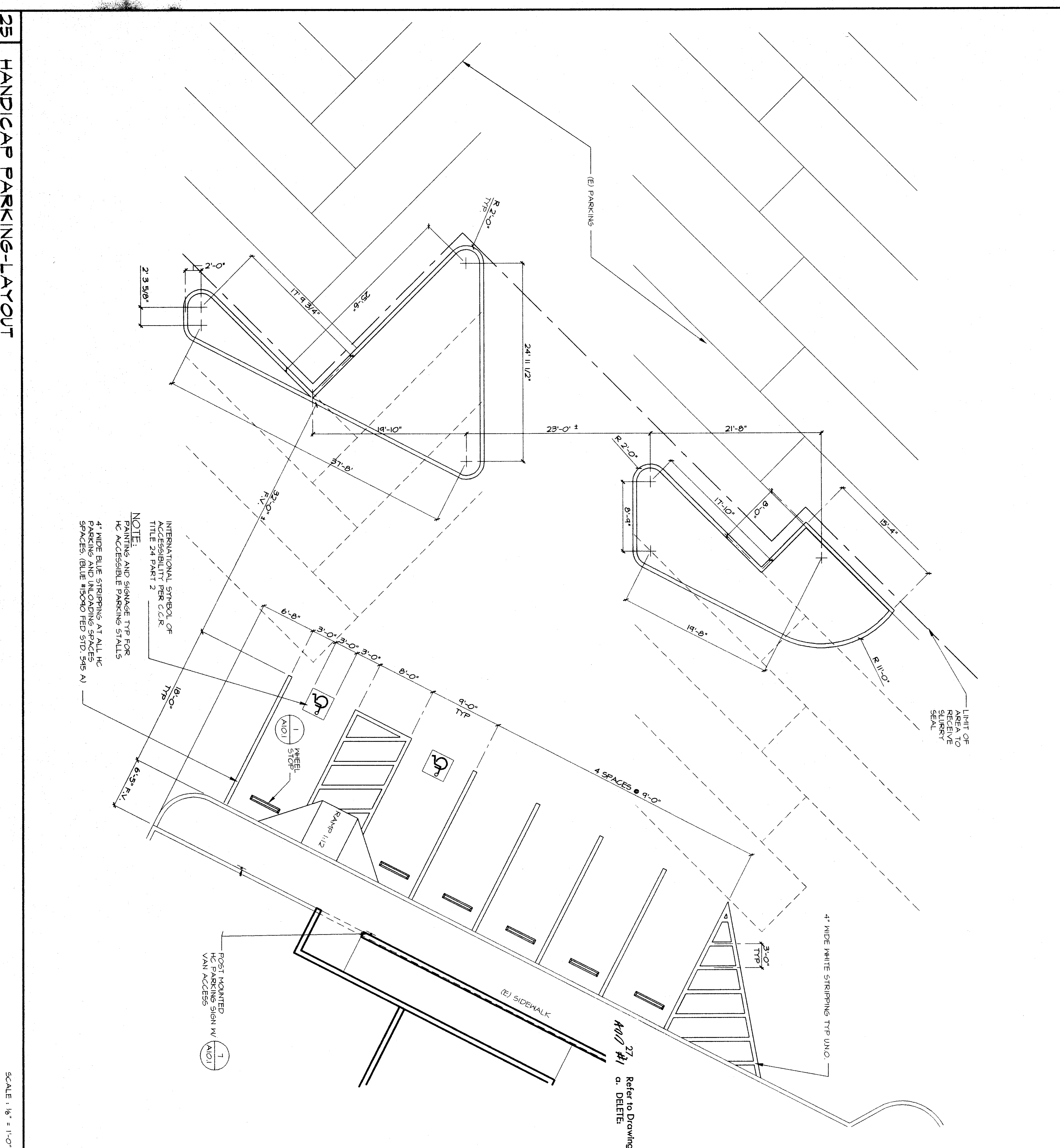

25 HANDICAP PARKING-LAYOUT
SCALE: 1/2" = 1'-0"

26 GYP BD WALL
SCALE: 3/4" = 1'-0"

29 TOILET PARTITION
SCALE: 3/4" = 1'-0"

30 REQD FLR CLEARANCES
SCALE: 1/2" = 1'-0"

ALLOWABLE SPAN FOR VERTICAL C-BRACE

BRACE	MIN SECTION PROPERTIES	MAX UNBRACED LENGTH	MAX UNBRACED LENGTH
1/2" x 2 1/2" x 1/8"	1/2" x 2 1/2" x 1/8" (IN 4)	0.001	0.02
3/8" x 2 1/2" x 1/8"	3/8" x 2 1/2" x 1/8" (IN 4)	0.001	0.02
3/8" x 2 1/2" x 1/8"	3/8" x 2 1/2" x 1/8" (IN 4)	0.001	0.02
3/8" x 2 1/2" x 1/8"	3/8" x 2 1/2" x 1/8" (IN 4)	0.001	0.02
3/8" x 2 1/2" x 1/8"	3/8" x 2 1/2" x 1/8" (IN 4)	0.001	0.02
3/8" x 2 1/2" x 1/8"	3/8" x 2 1/2" x 1/8" (IN 4)	0.001	0.02
3/8" x 2 1/2" x 1/8"	3/8" x 2 1/2" x 1/8" (IN 4)	0.001	0.02
3/8" x 2 1/2" x 1/8"	3/8" x 2 1/2" x 1/8" (IN 4)	0.001	0.02
3/8" x 2 1/2" x 1/8"	3/8" x 2 1/2" x 1/8" (IN 4)	0.001	0.02
3/8" x 2 1/2" x 1/8"	3/8" x 2 1/2" x 1/8" (IN 4)	0.001	0.02

NOTES:
1. MIN R_y = 33 KS
2. WELDED BRACE DO NOT SLICE

16 LOW WALL END
SCALE: 1/2" = 1'-0"

17 SPLAY HANGER WIRE
SCALE: 1/2" = 1'-0"

22 MAGAZINE RACK
SCALE: 1/2" = 1'-0"

23 BRACE AT KNEE SPACE
SCALE: 1/2" = 1'-0"

24 STUD CHANNEL TO ROOF FRMG
SCALE: 1/2" = 1'-0"

29 TOILET PARTITION
SCALE: 3/4" = 1'-0"

30 REQD FLR CLEARANCES
SCALE: 1/2" = 1'-0"

**RUTH HARDING SCHOOL
MODERNIZATION
3201 PICO AVE.
FOR
BAKERSFIELD CITY SCHOOL DISTRICT
BAKERSFIELD, KERN COUNTY, CALIFORNIA**

DETAILS

10.1
27 OF 21 SHEETS

SCA
Architect, Inc.
1901 L Street
Bakersfield, CA 93301
(805) 577-1933

**LICENCED ARCHITECT
NO. 10182
STATE OF CALIFORNIA**

SCA
Architect, Inc.
1901 L Street
Bakersfield, CA 93301
(805) 577-1933

**IDENTIFICATION STAMP
NO. OF THE STATE ARCHITECT
DATE: 03-10-2016
TEL: 5-6**

**JOB NO.
957**

DATE: 03/10/16

MARK DATE REVISIONS

**CHECK AND VERIFY ALL DIMENSIONS
BEFORE PROCEEDING WITH THE
WORK. REPORT DISCREPANCIES
TO THE ARCHITECT. ALL
CONSTRUCTION SHALL CONFORM
TO THE BIDDING.**