

FLEWELLING & MOODY
architects • education

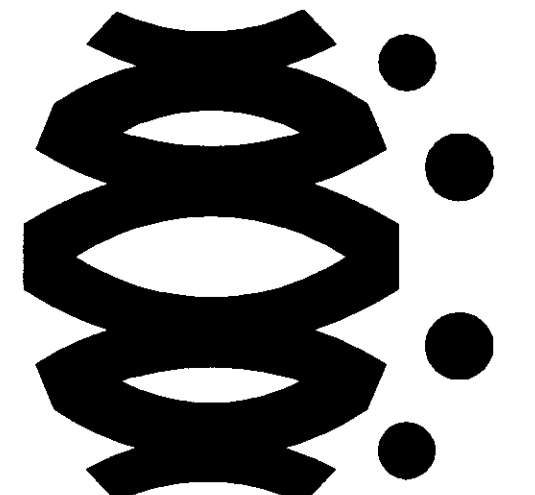

HEADQUARTERS OFFICE:
1400 Broadway, Suite 300
Berkeley, California 94704
Tel: (415) 841-1111
Fax: (415) 841-1112
Email: flewelling@flewellingmoody.com

ALTAREE WALKER OFFICE:
1500 California Street
Oakland, California 94612
Tel: (510) 464-2777
Fax: (510) 464-2730
Email: flewelling@flewellingmoody.com

An Equal Opportunity Employer

REGISTERED ARCHITECT
STATE OF CALIFORNIA
No. 14117

REGISTERED ARCHITECT
STATE OF CALIFORNIA
No. 45872

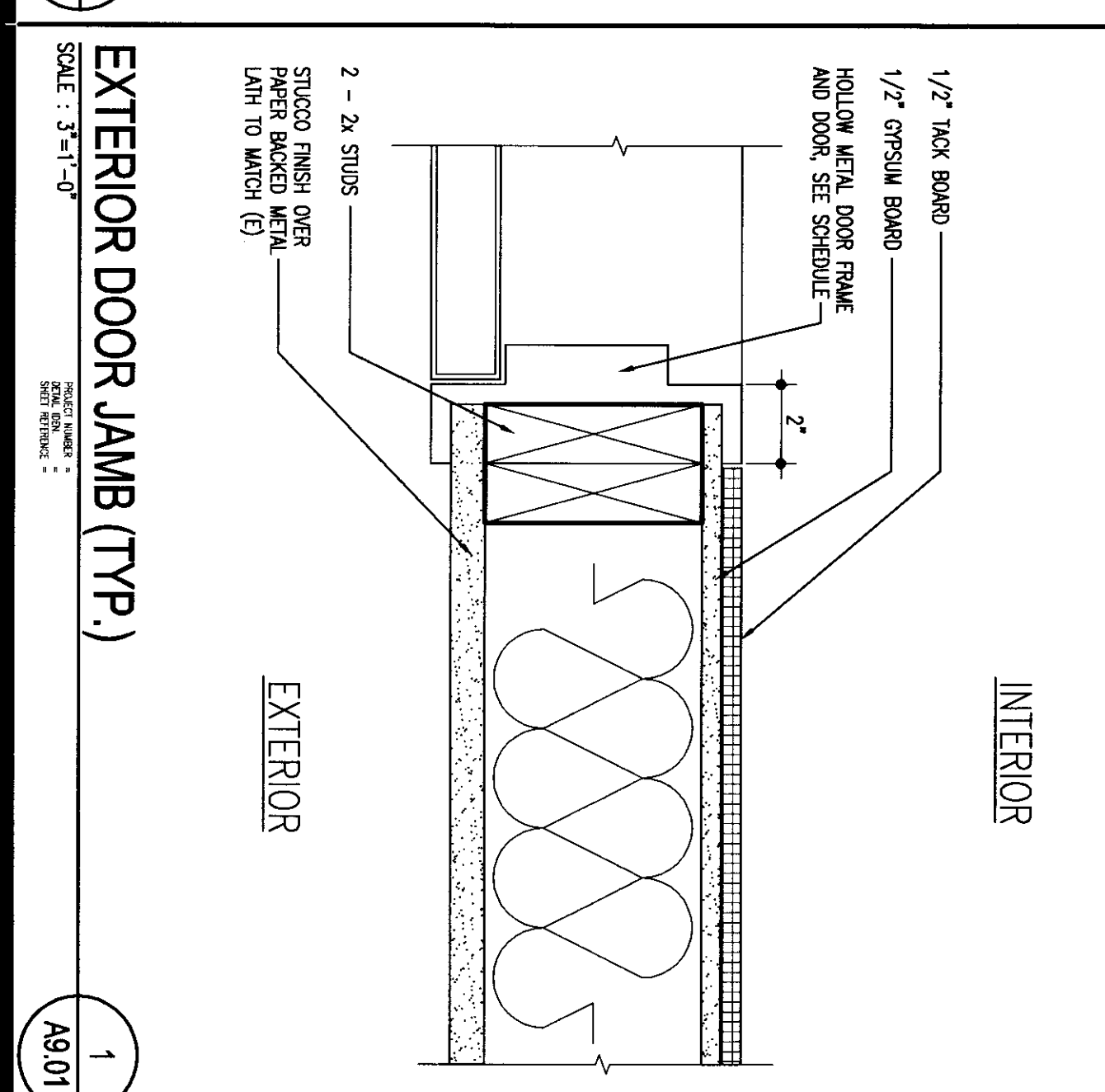
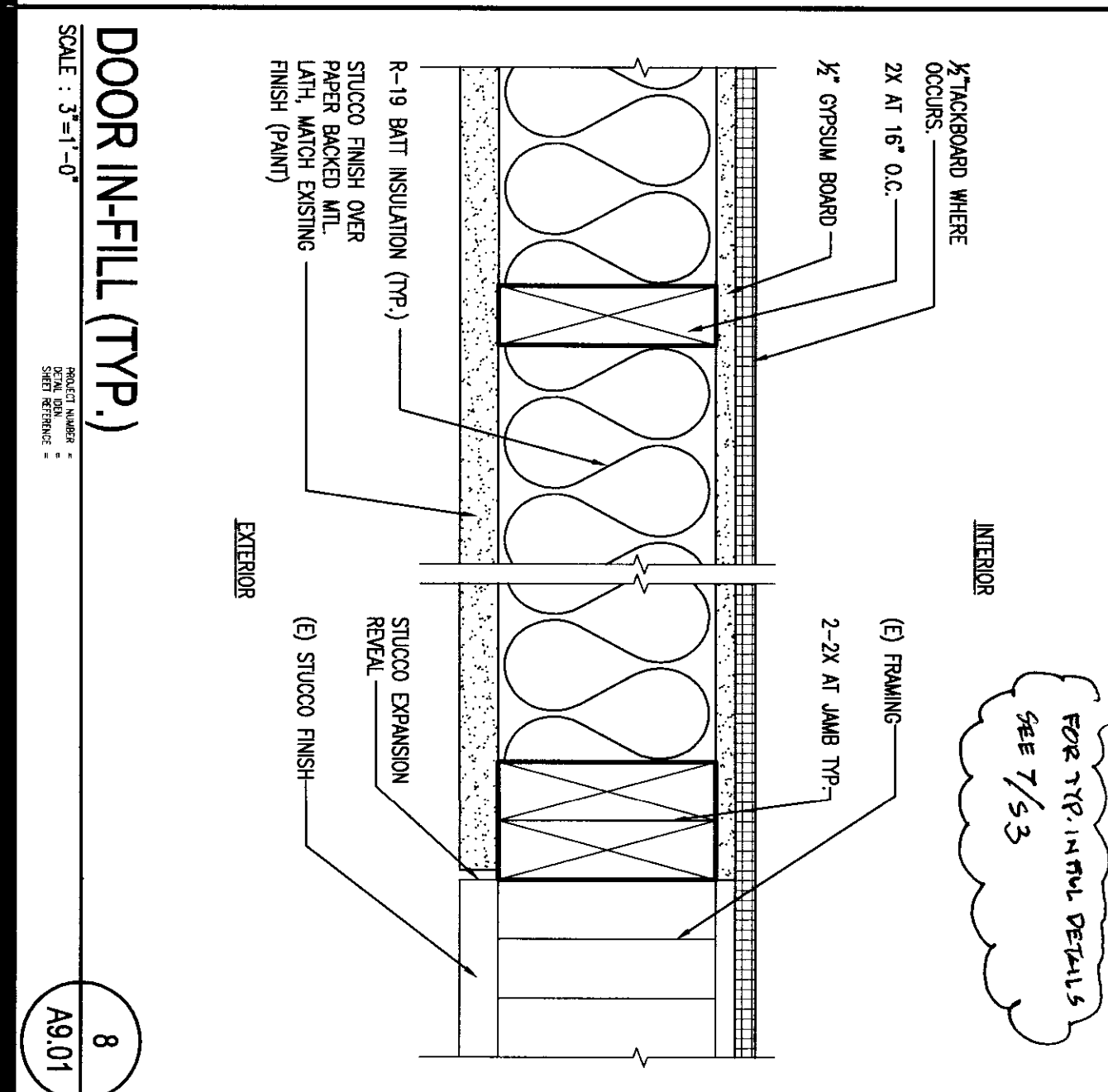
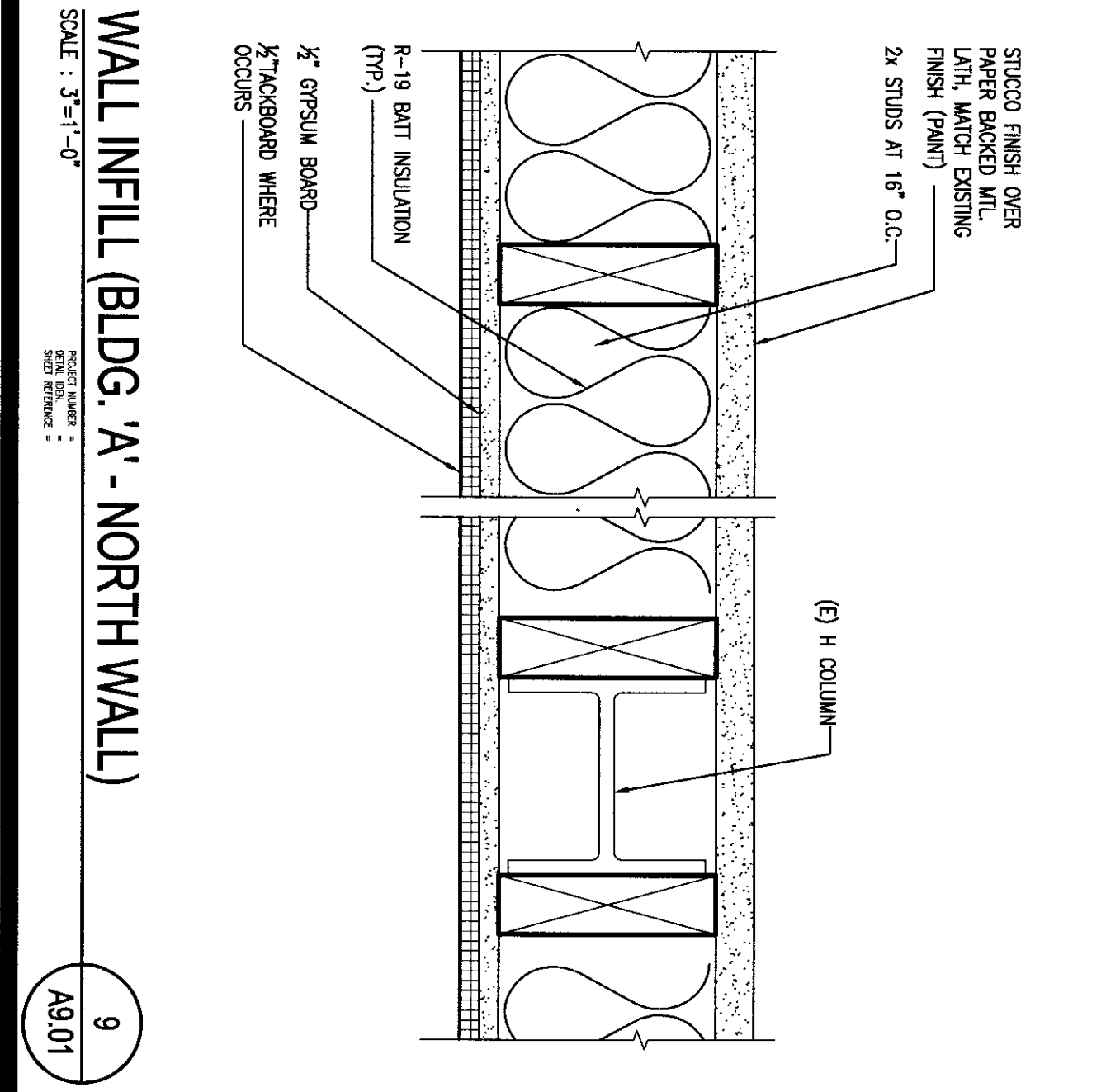
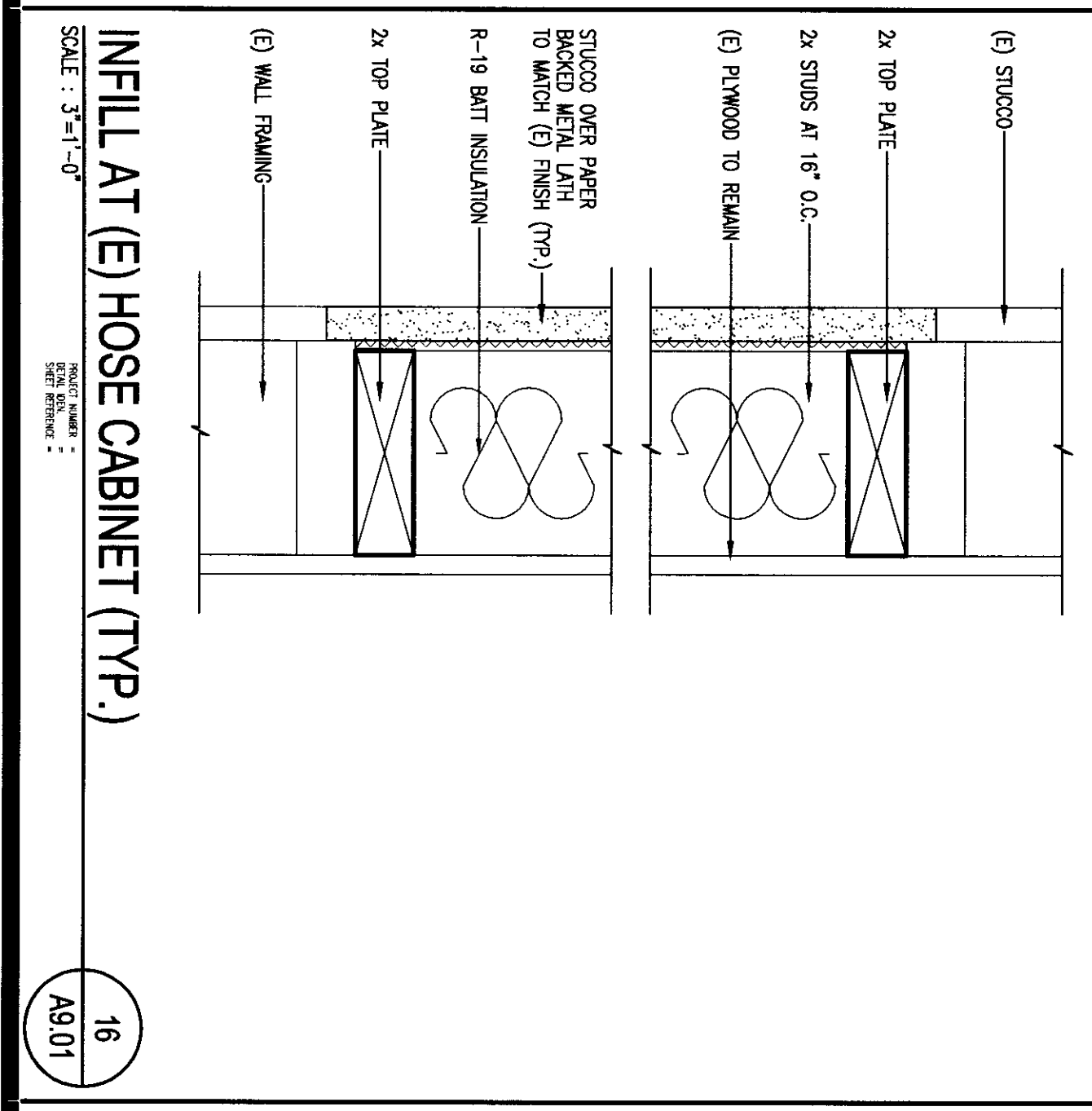
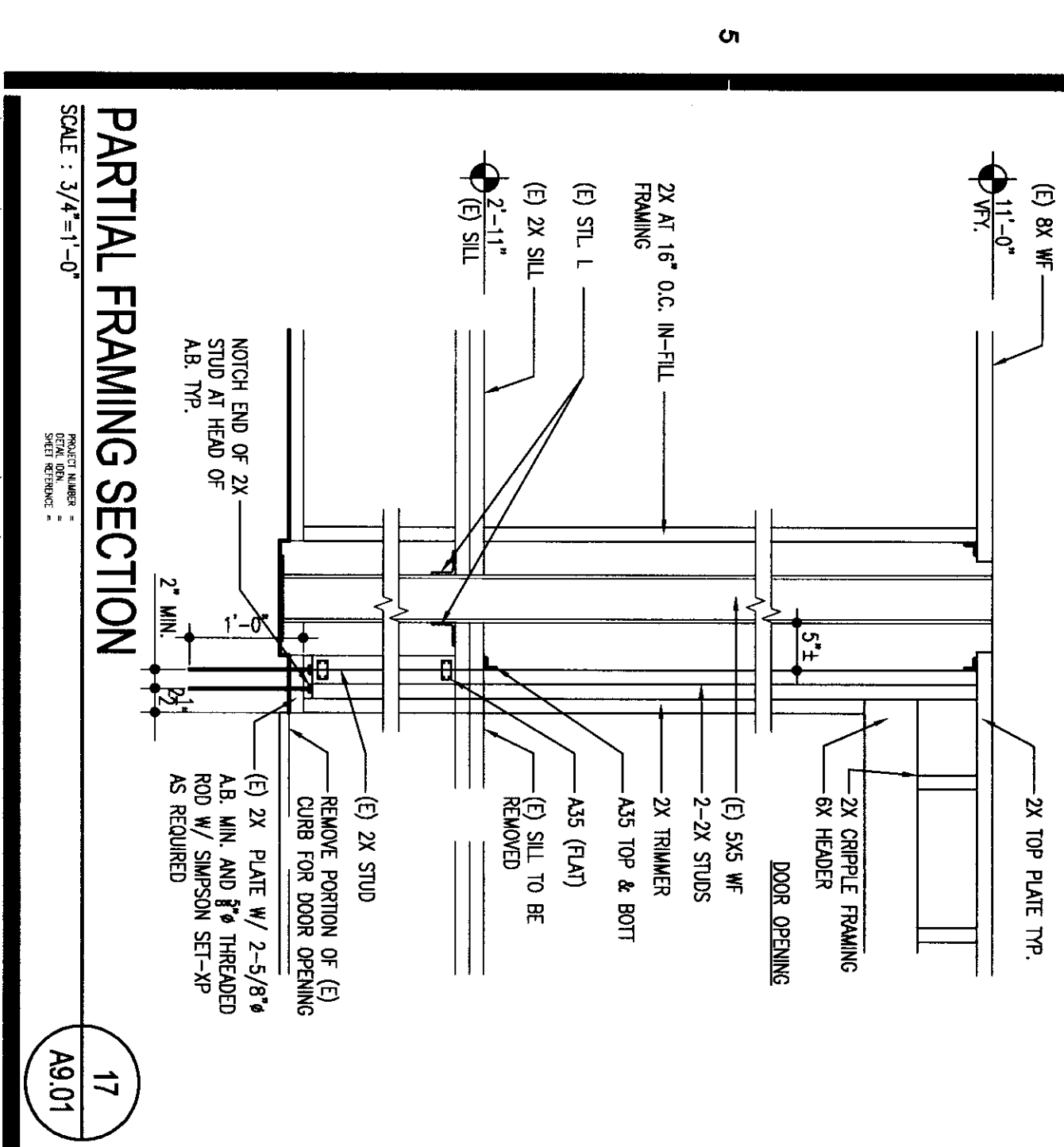
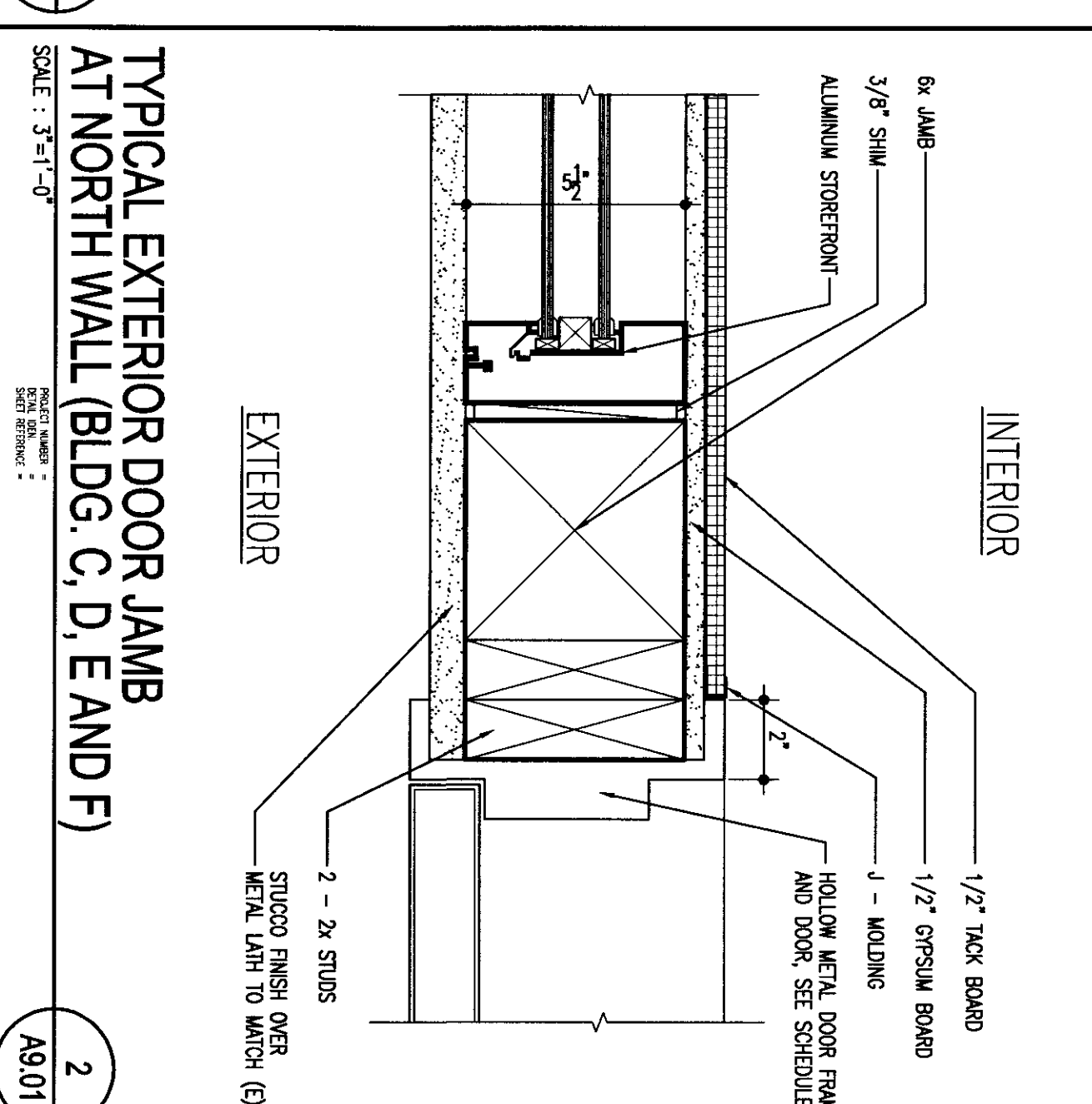
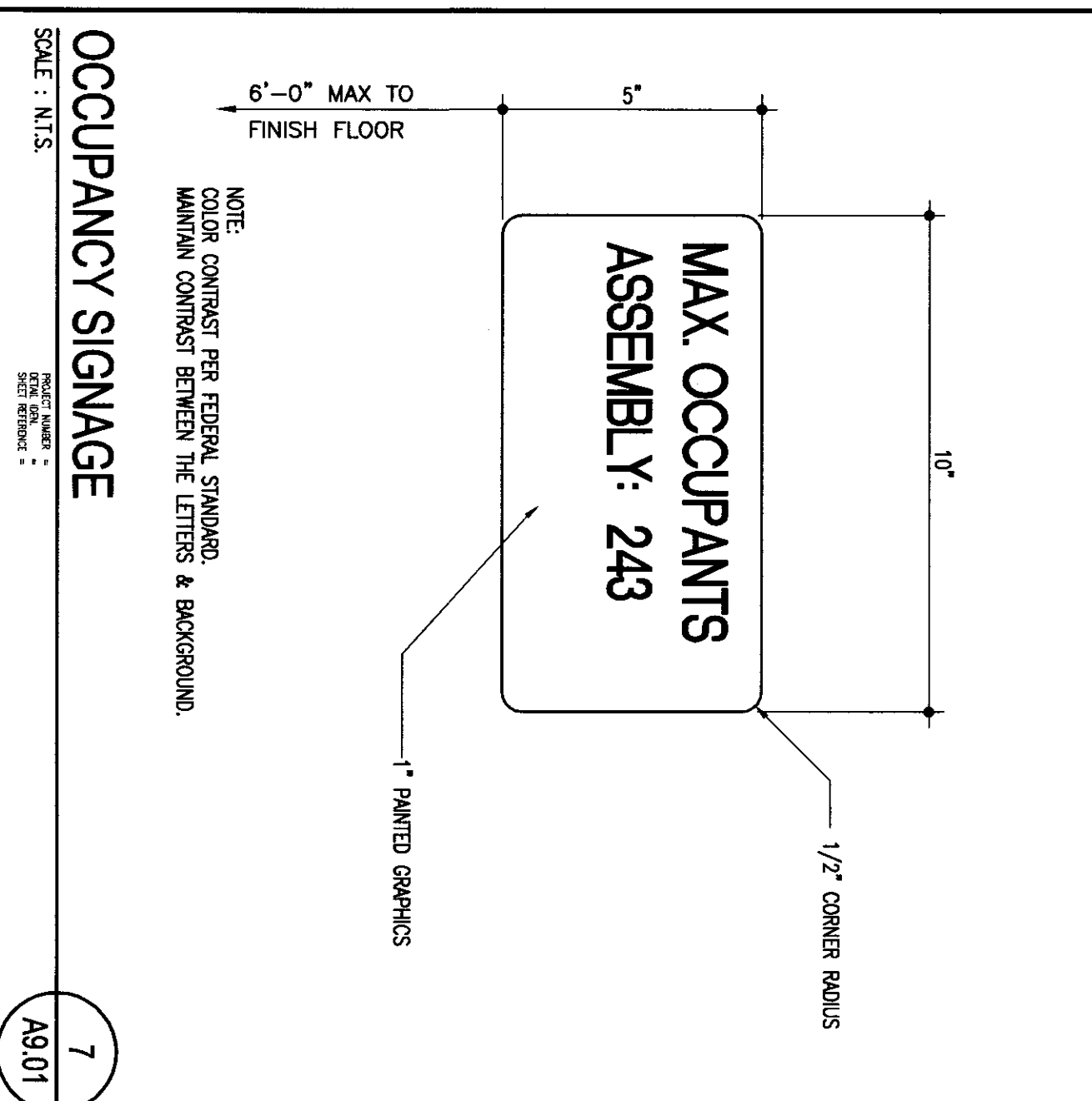
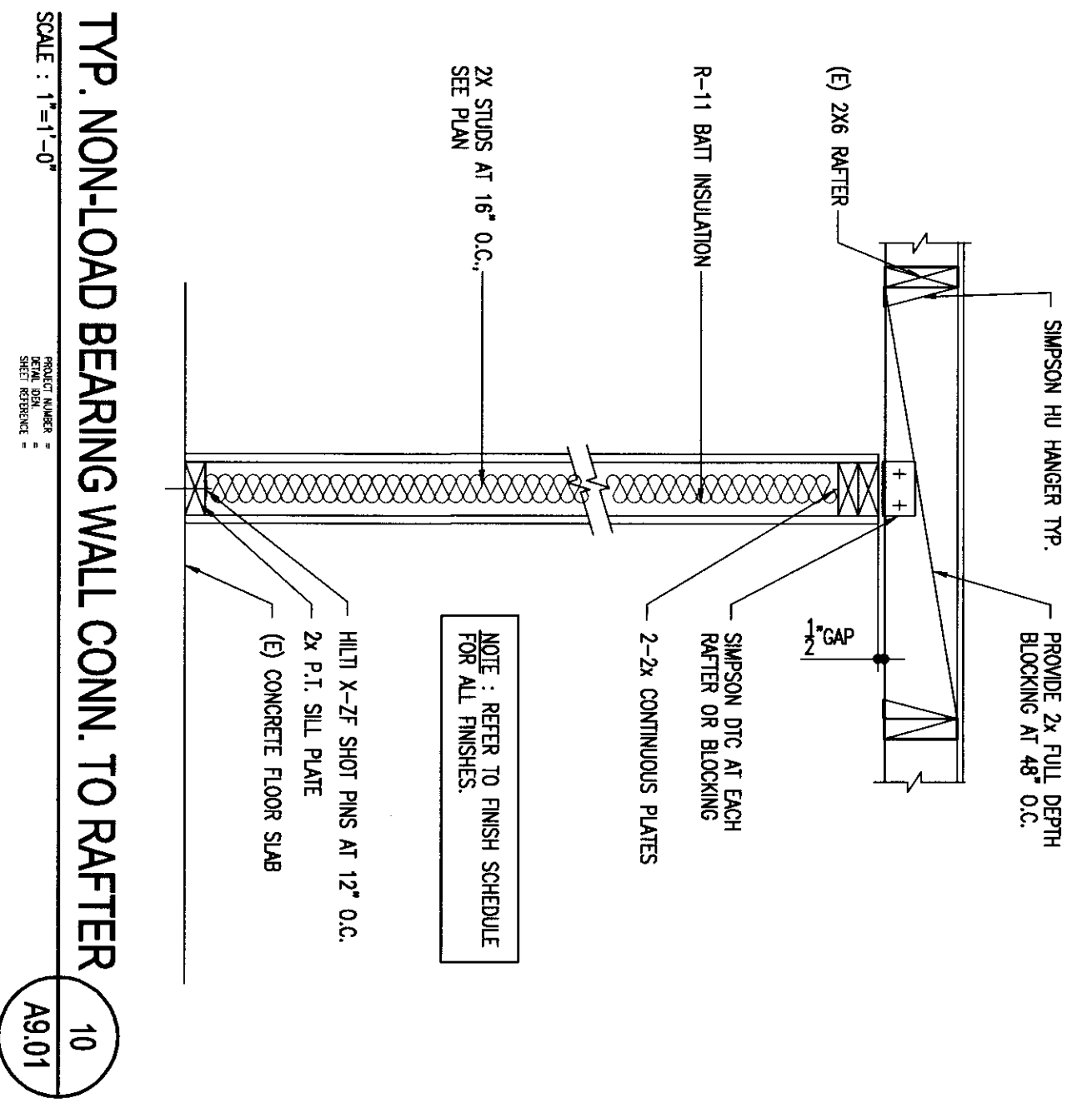
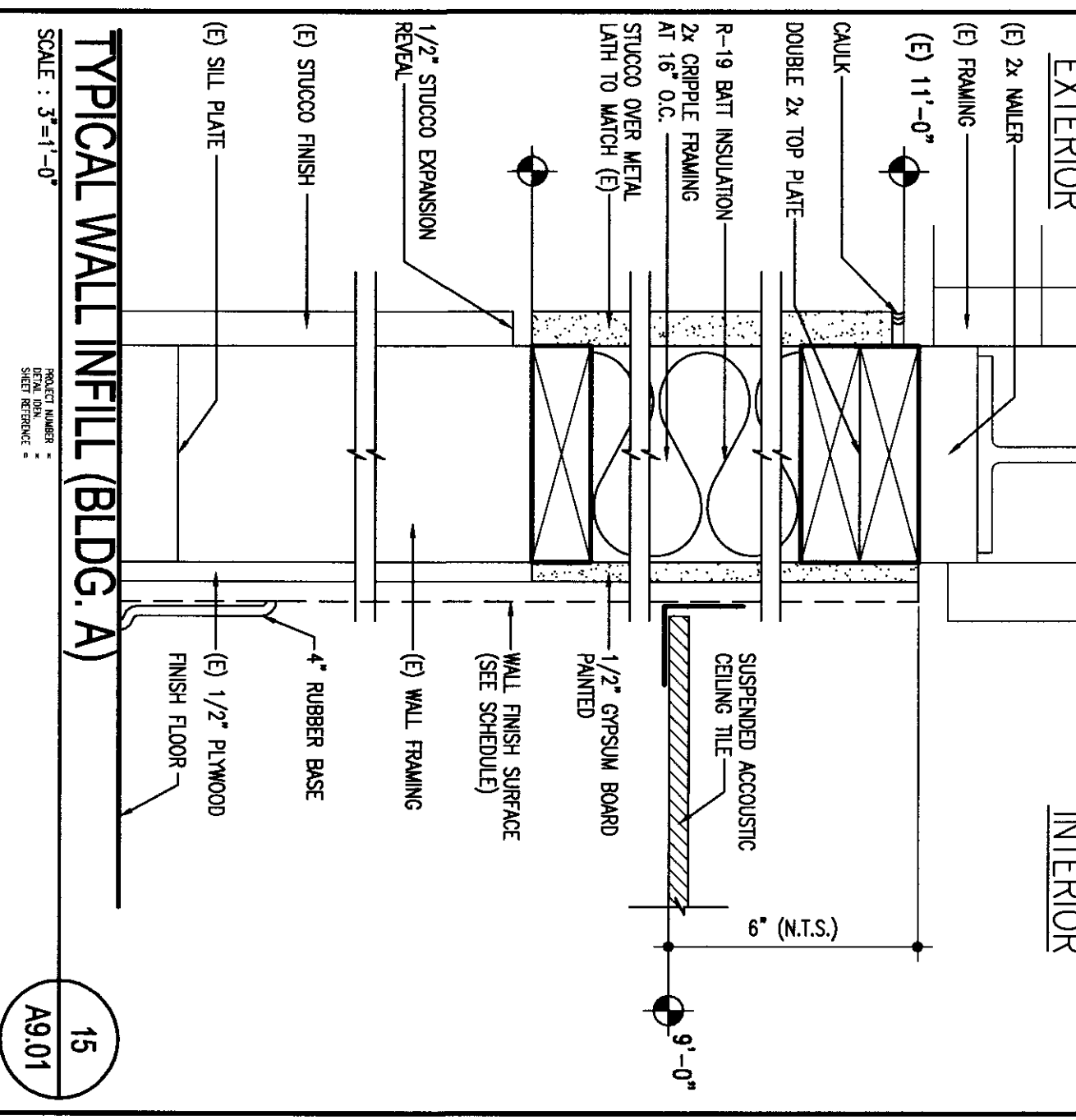
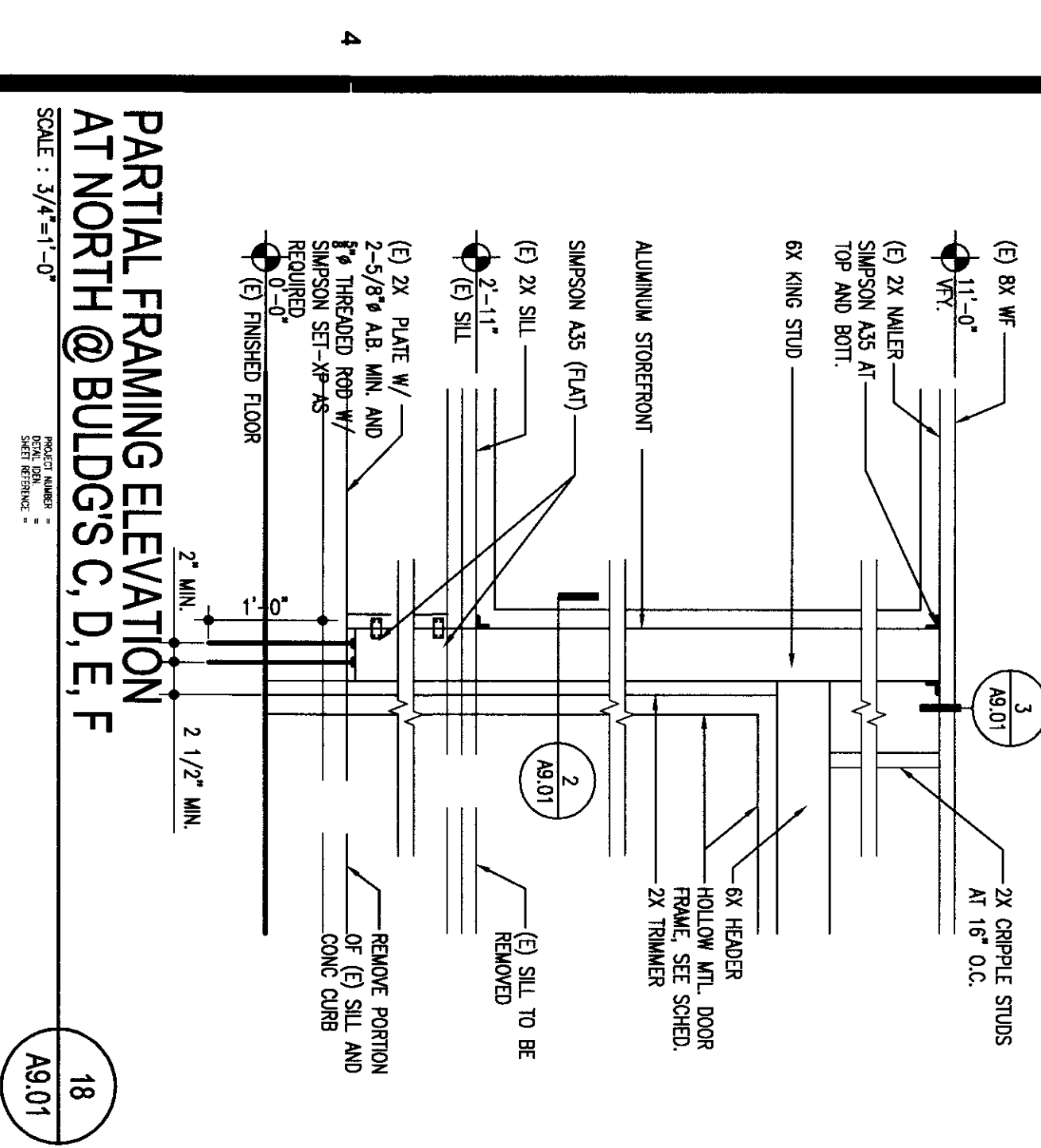
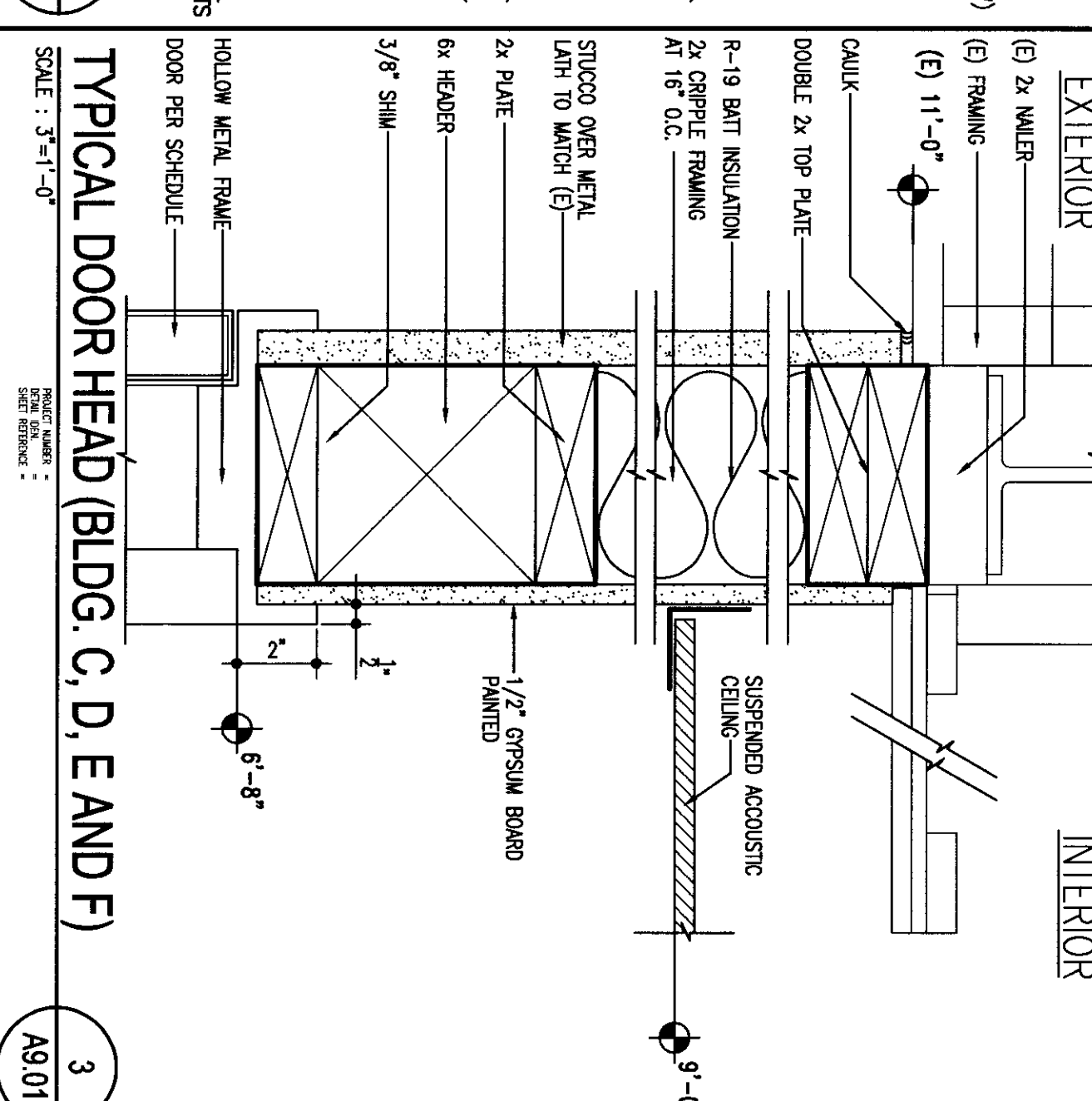
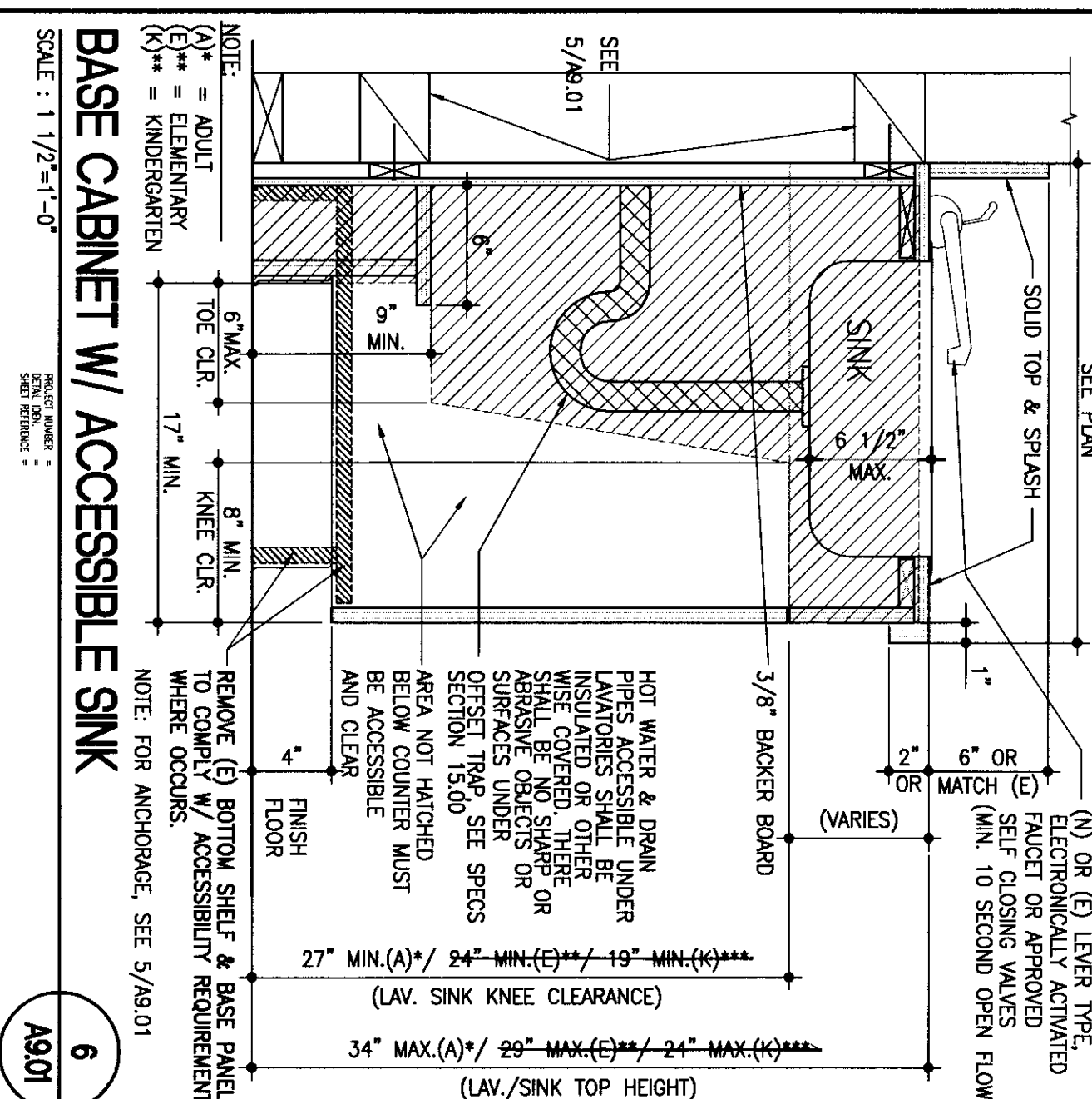
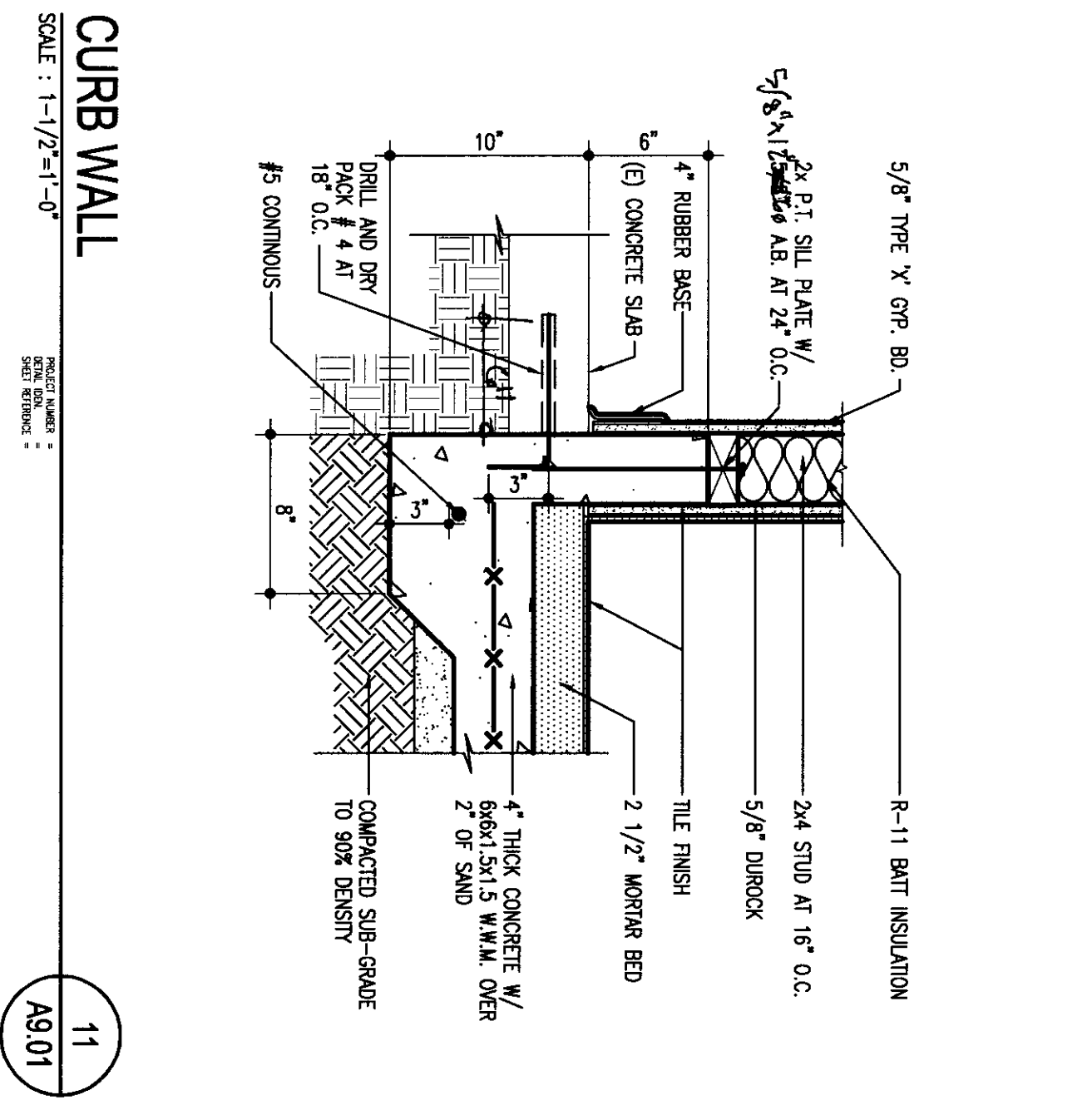
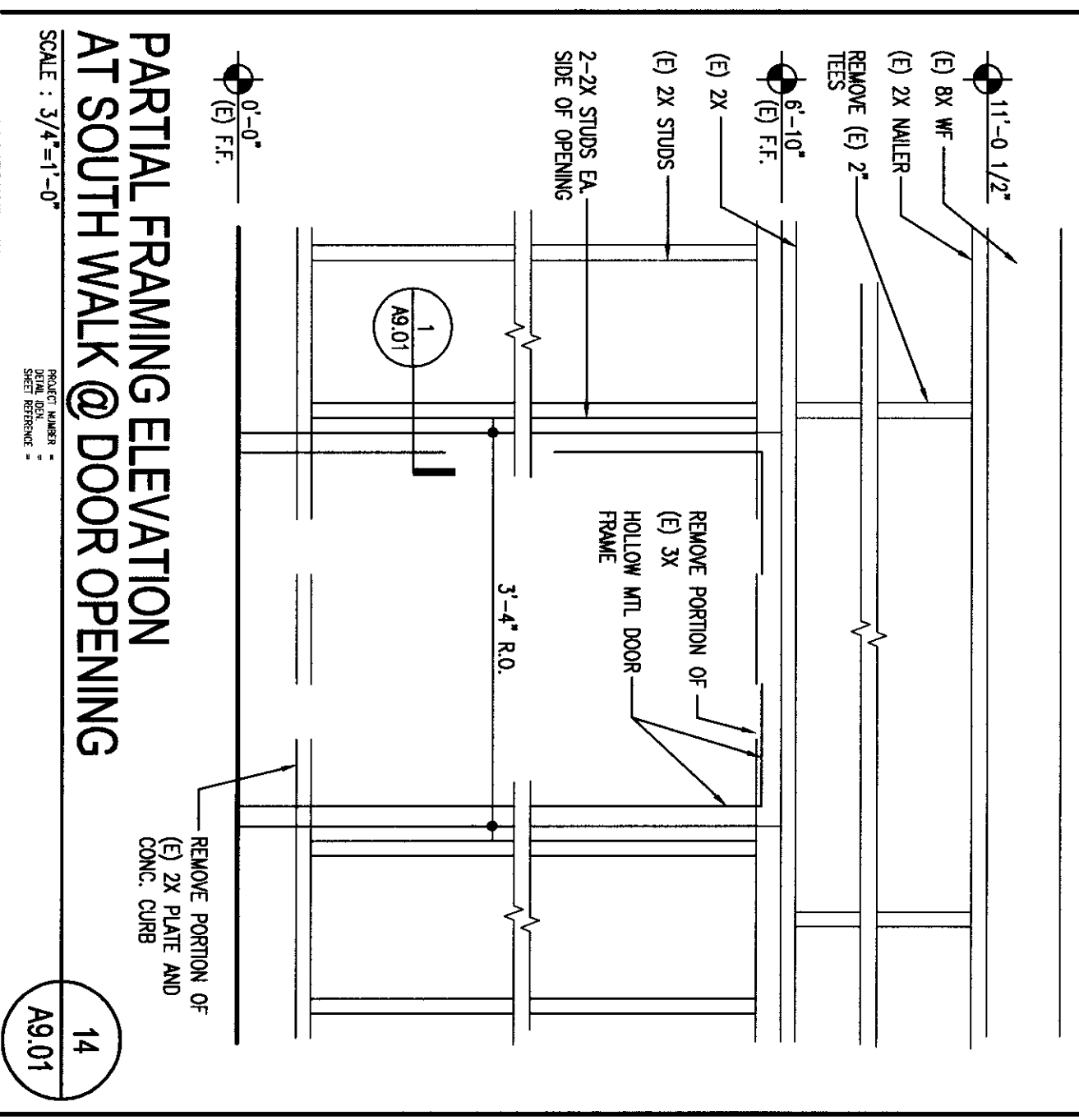
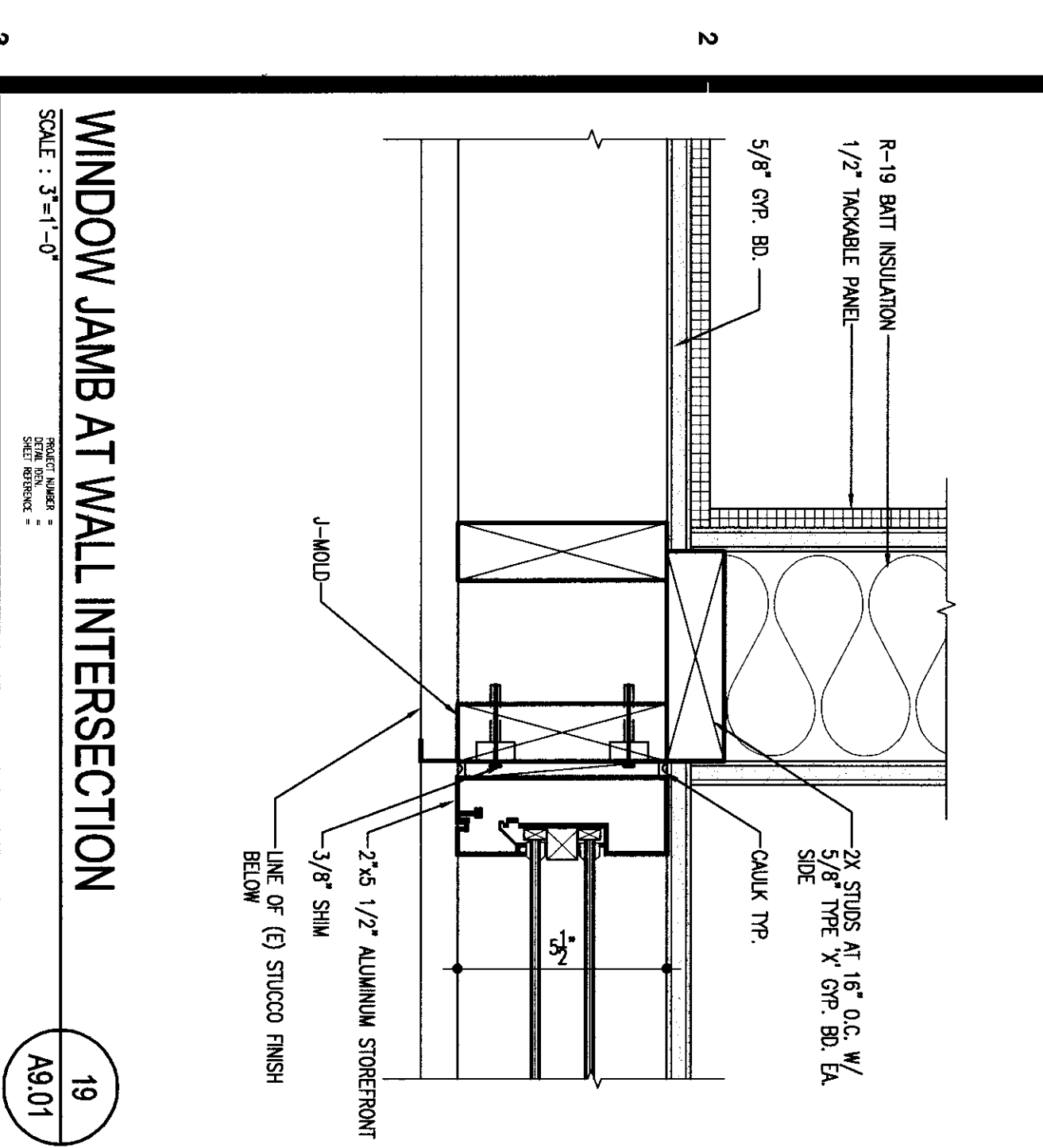
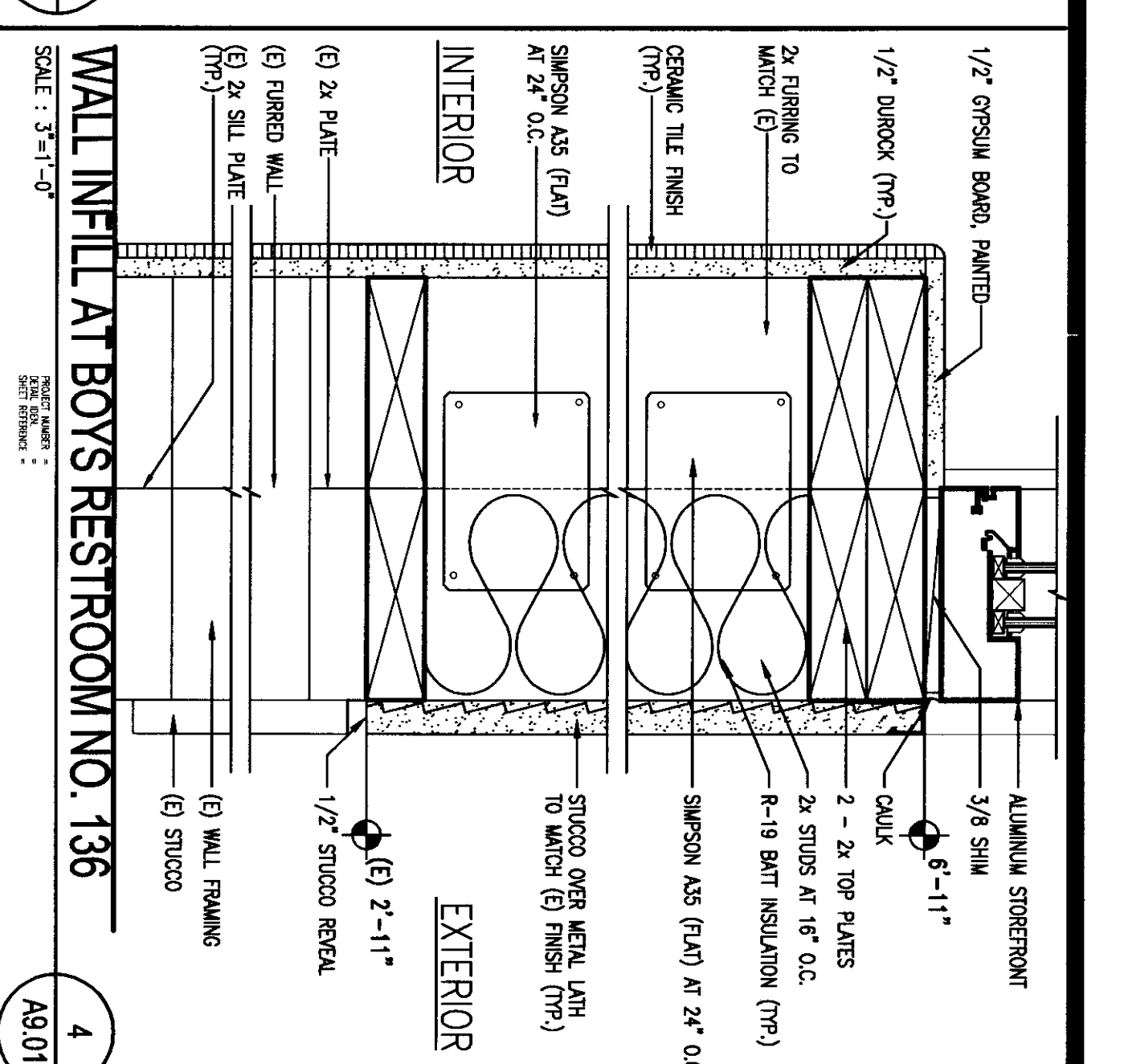
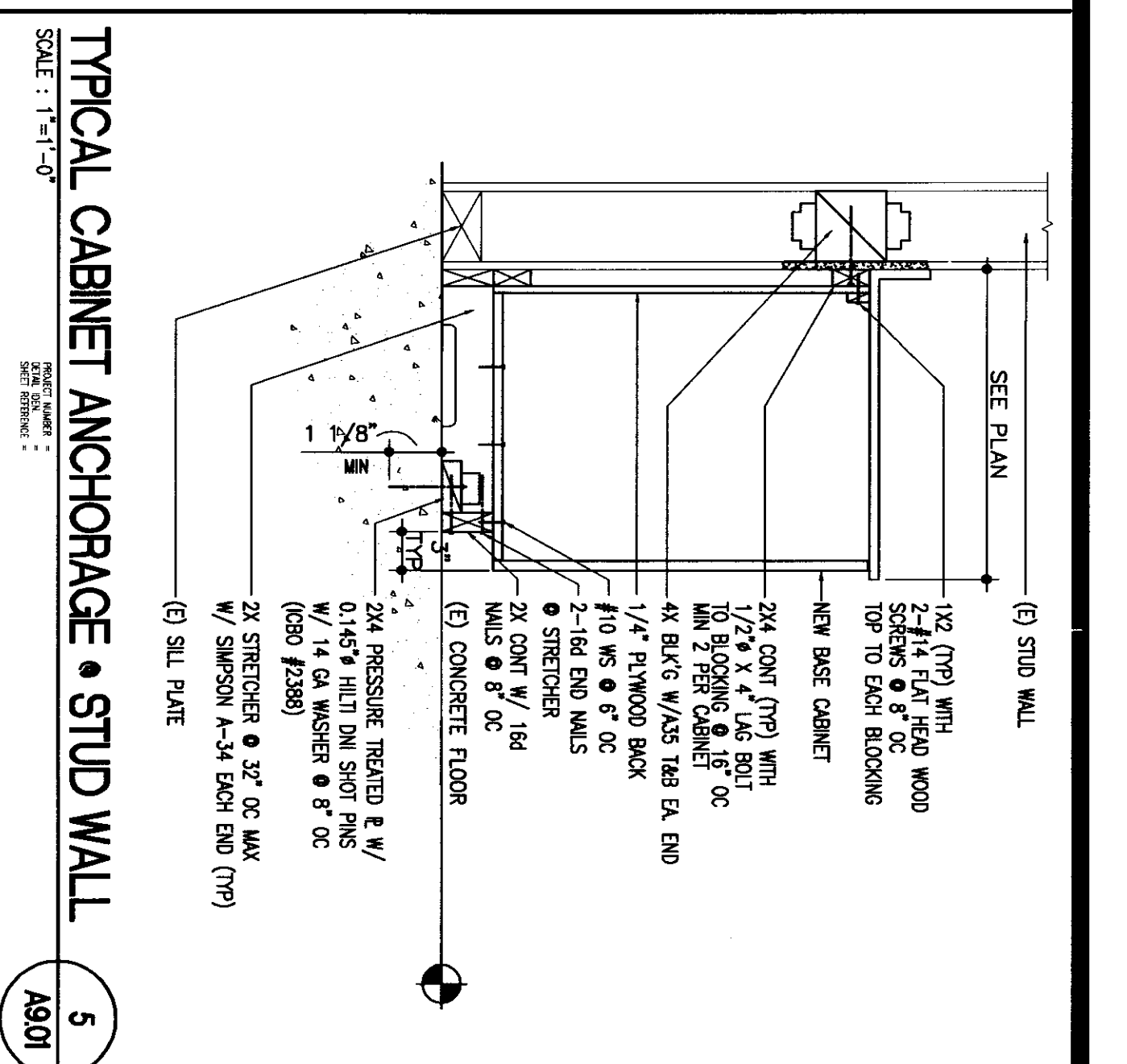
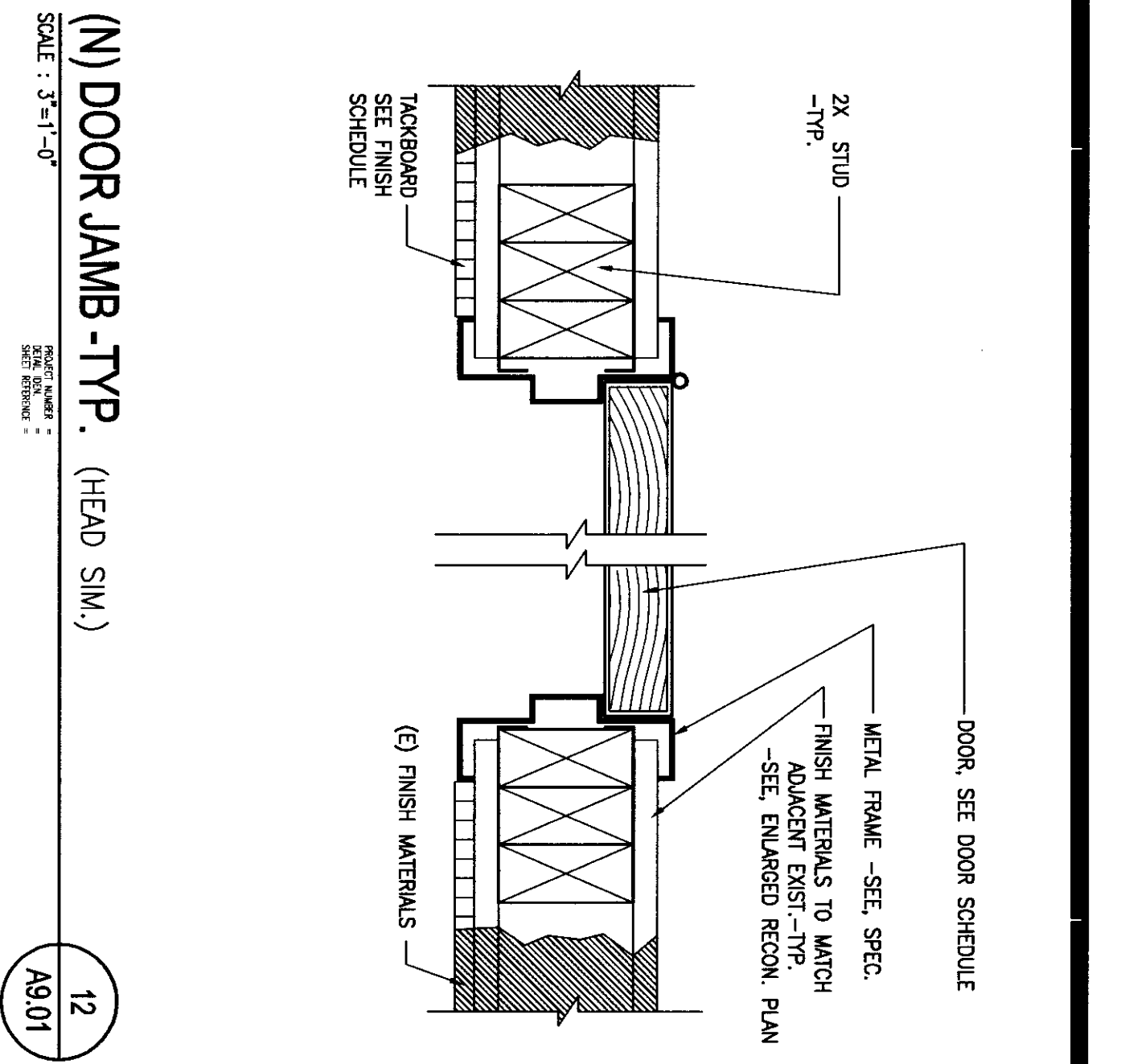
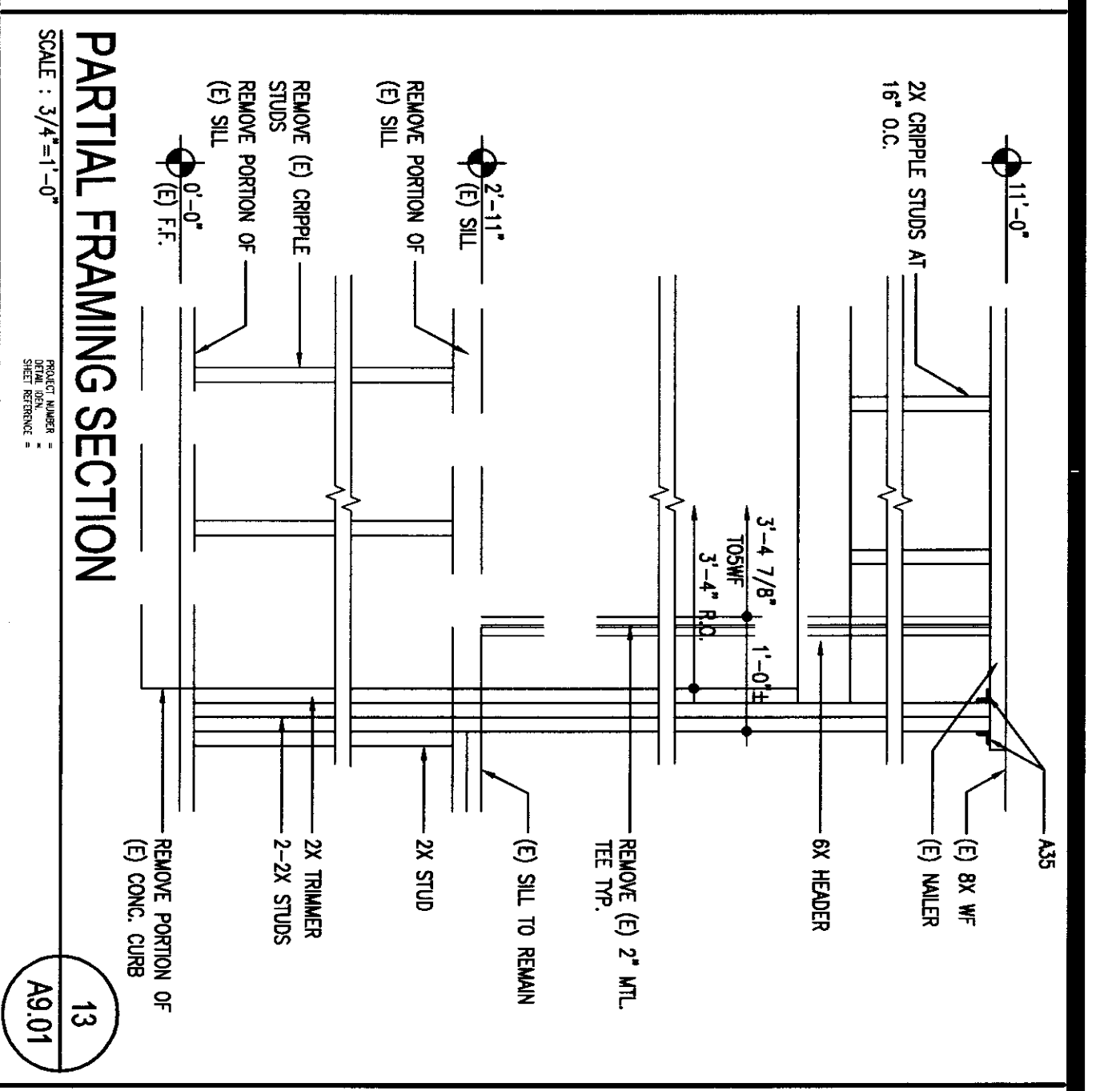
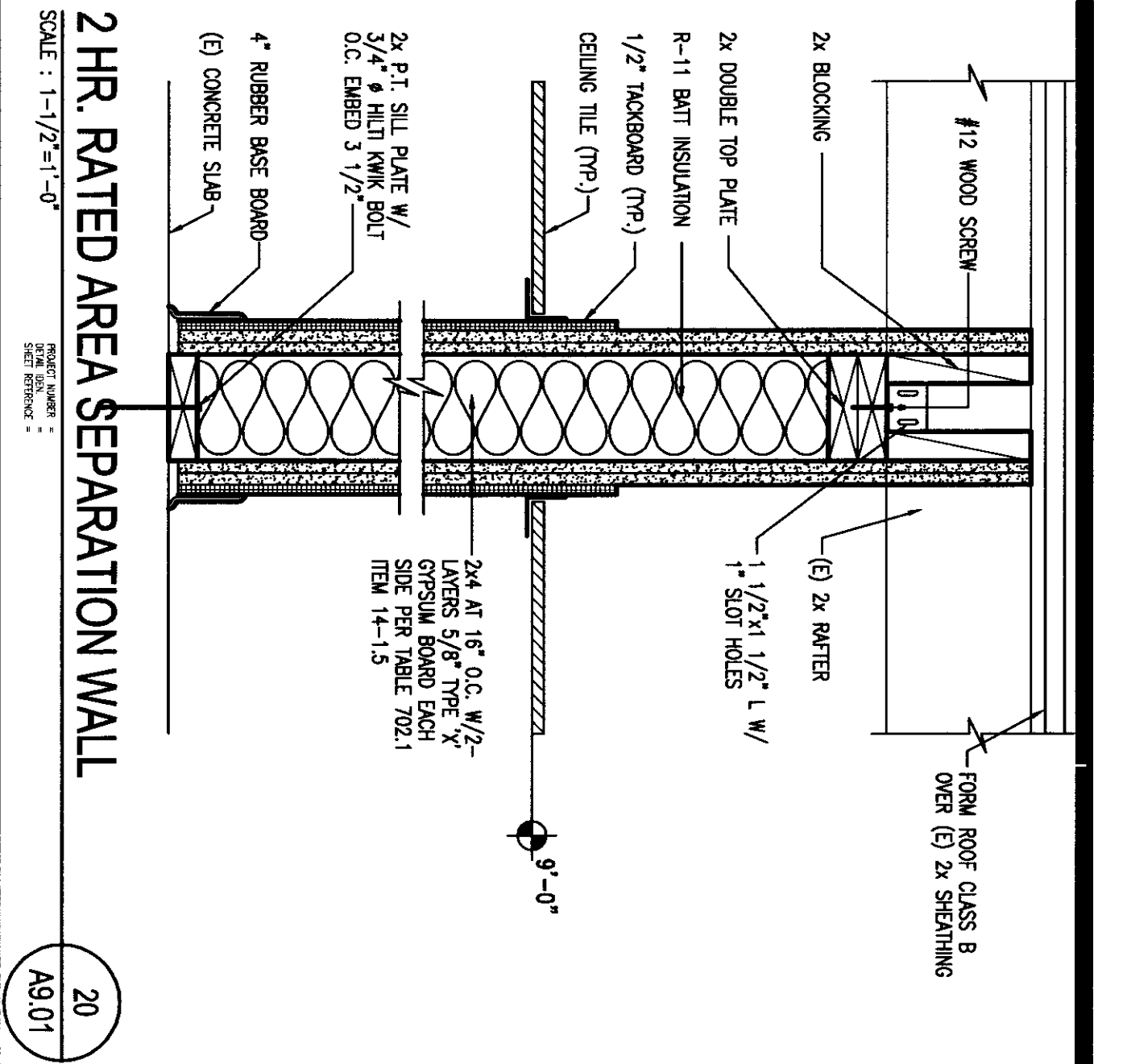

PROJECT: MODERNIZATION PROJECT AT EVERGREEN ELEMENTARY SCHOOL
2500 ROSE WARE DRIVE
BAKERSFIELD, CA 93304

BAKERSFIELD CITY SCHOOL DISTRICT

DETAILS

1-26-2010

A9.01

1894