

**SHUT-OFF VALVE IN BOX DETAIL**  
SCALE: NONE

N  
MP-5

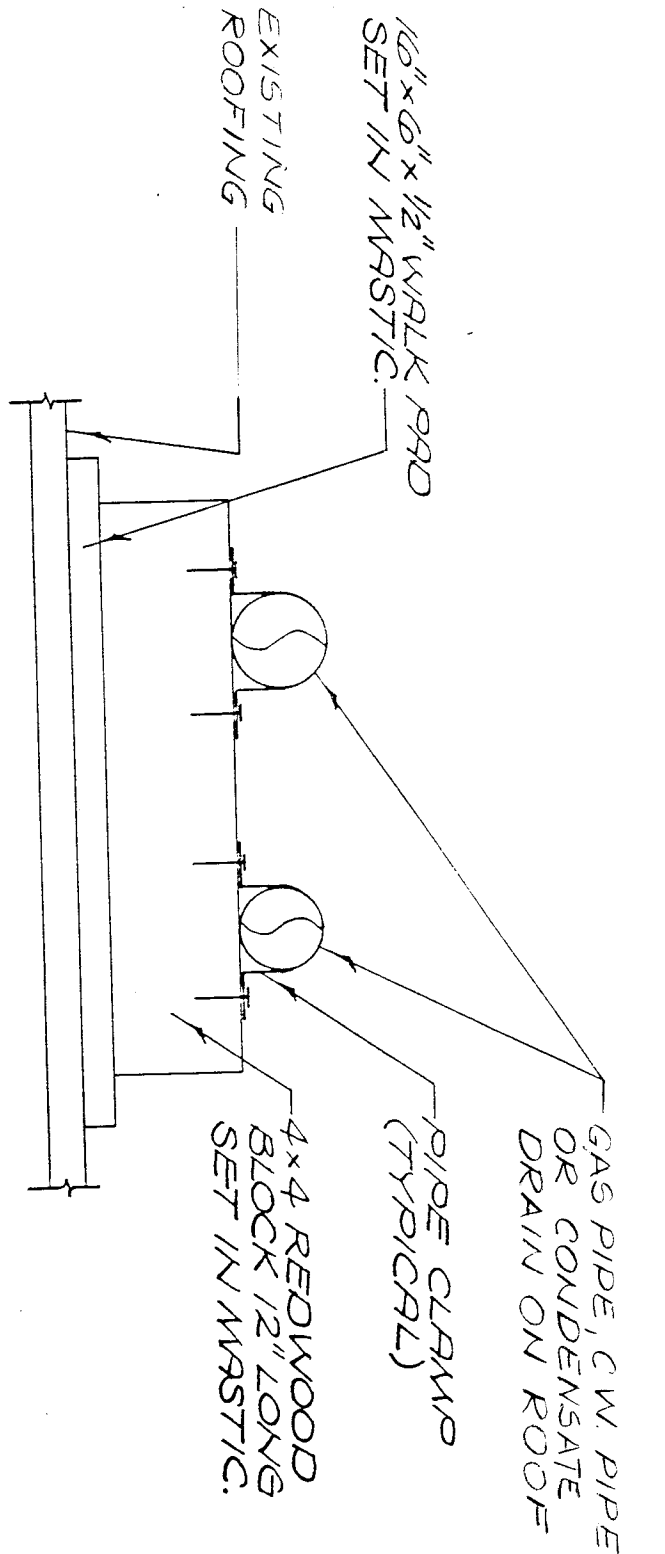

**PIPE SUPPORT**  
SCALE: NONE

J  
MP-5

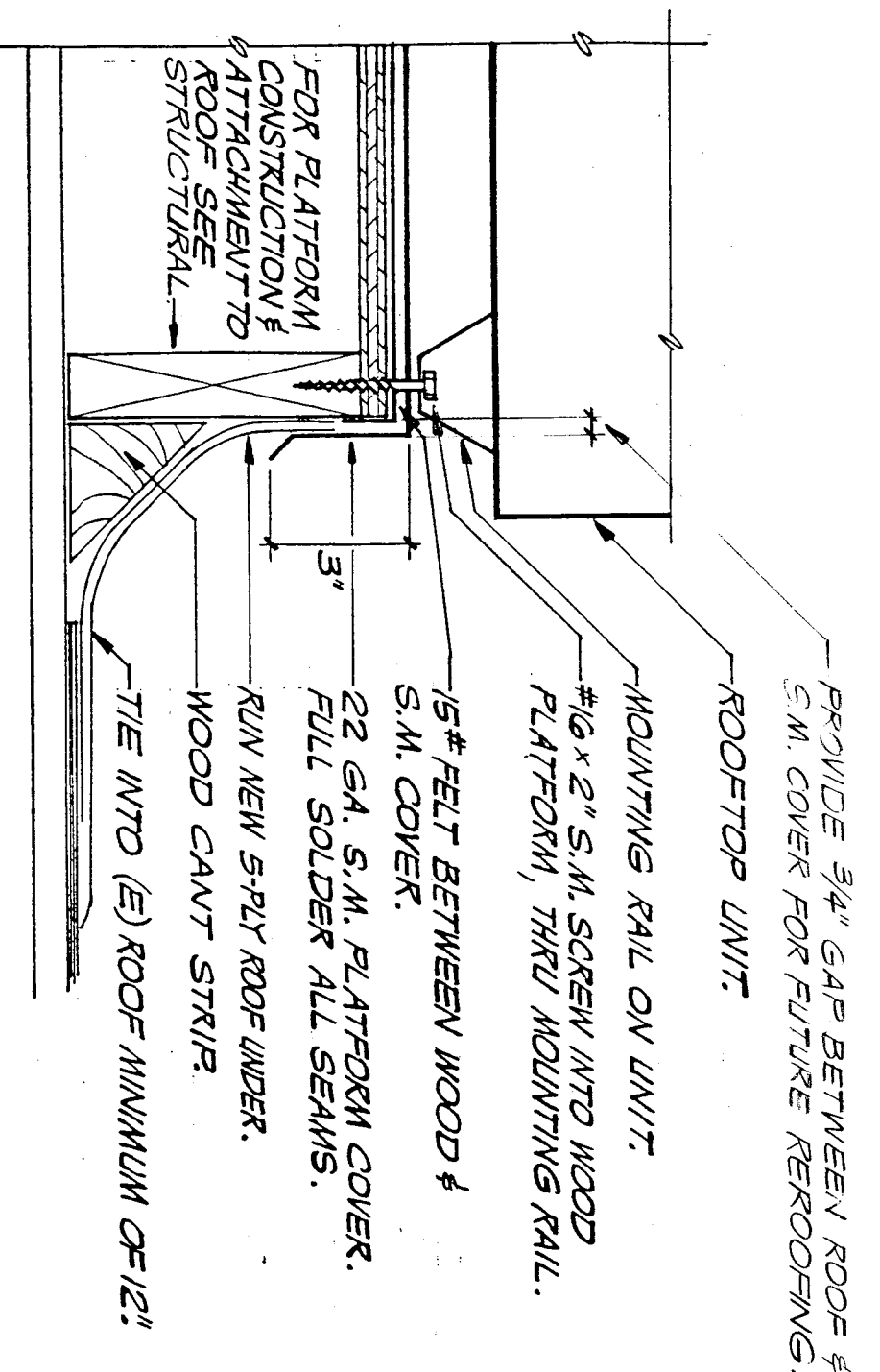

**EQUIPMENT PLATFORM DETAIL**  
SCALE: NONE

E  
MP-5

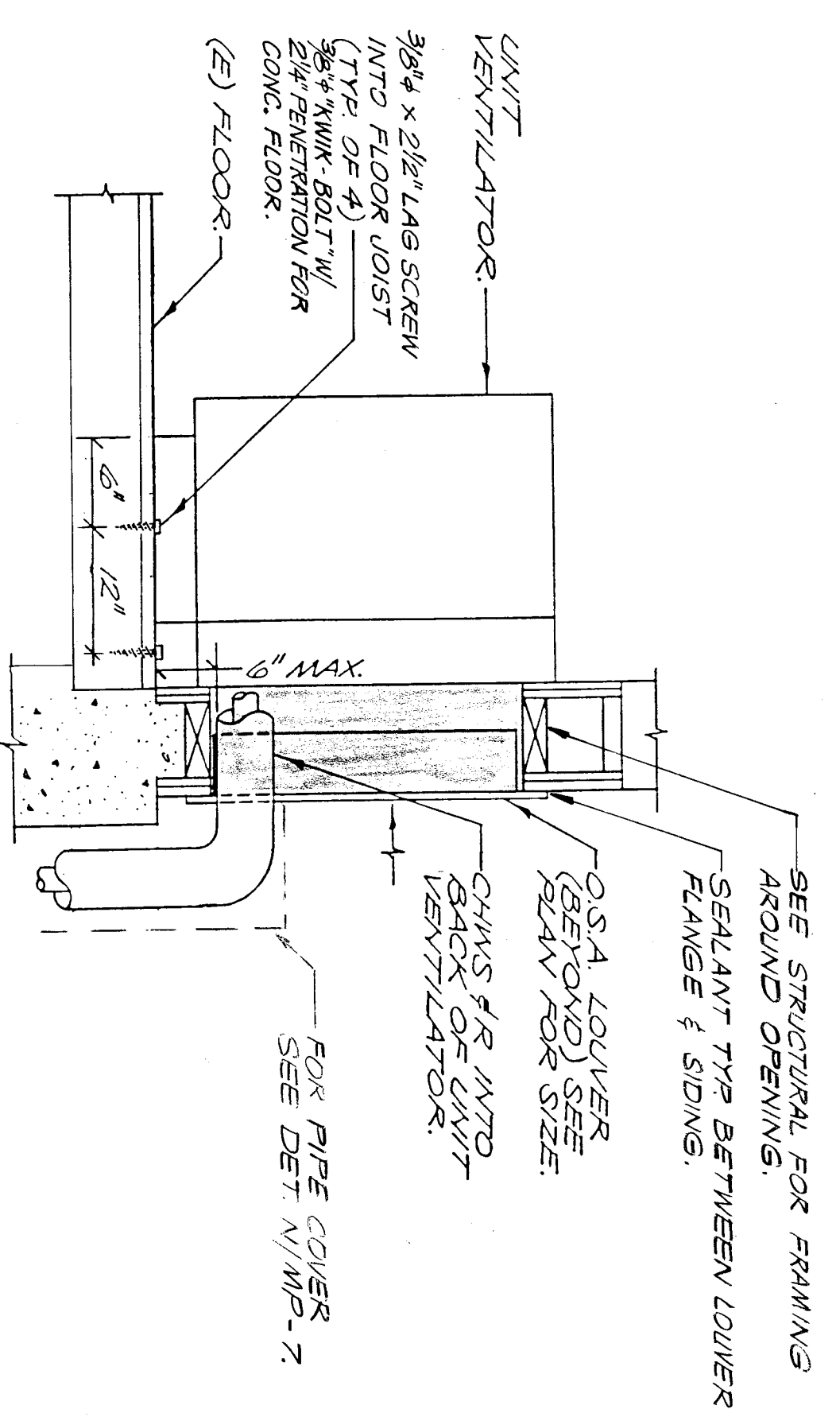

**SECTION AT UNIT VENTILATOR**  
SCALE: NONE

A  
MP-5

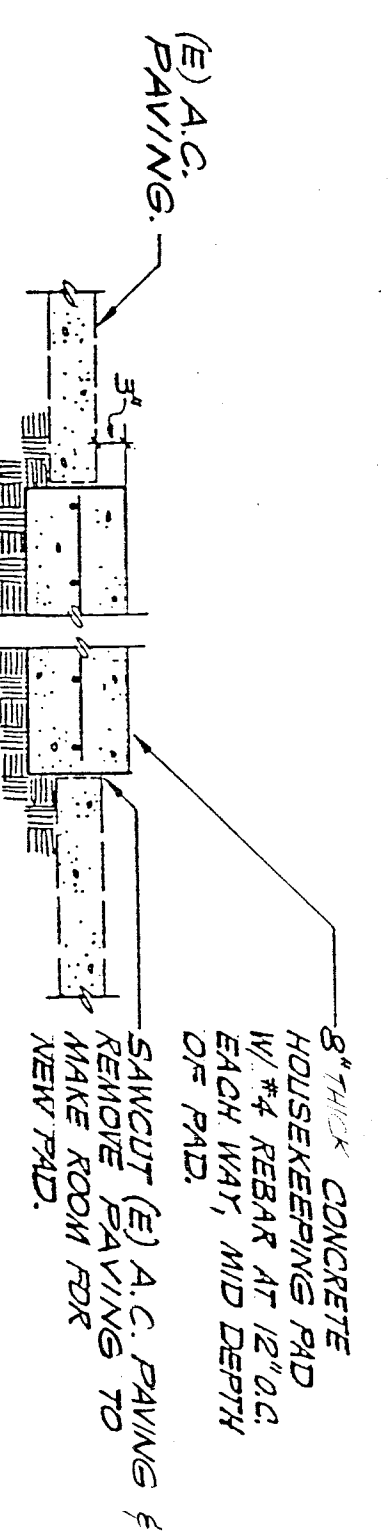

**BRINE CHILLER PAD**  
SCALE: NONE

P  
MP-5

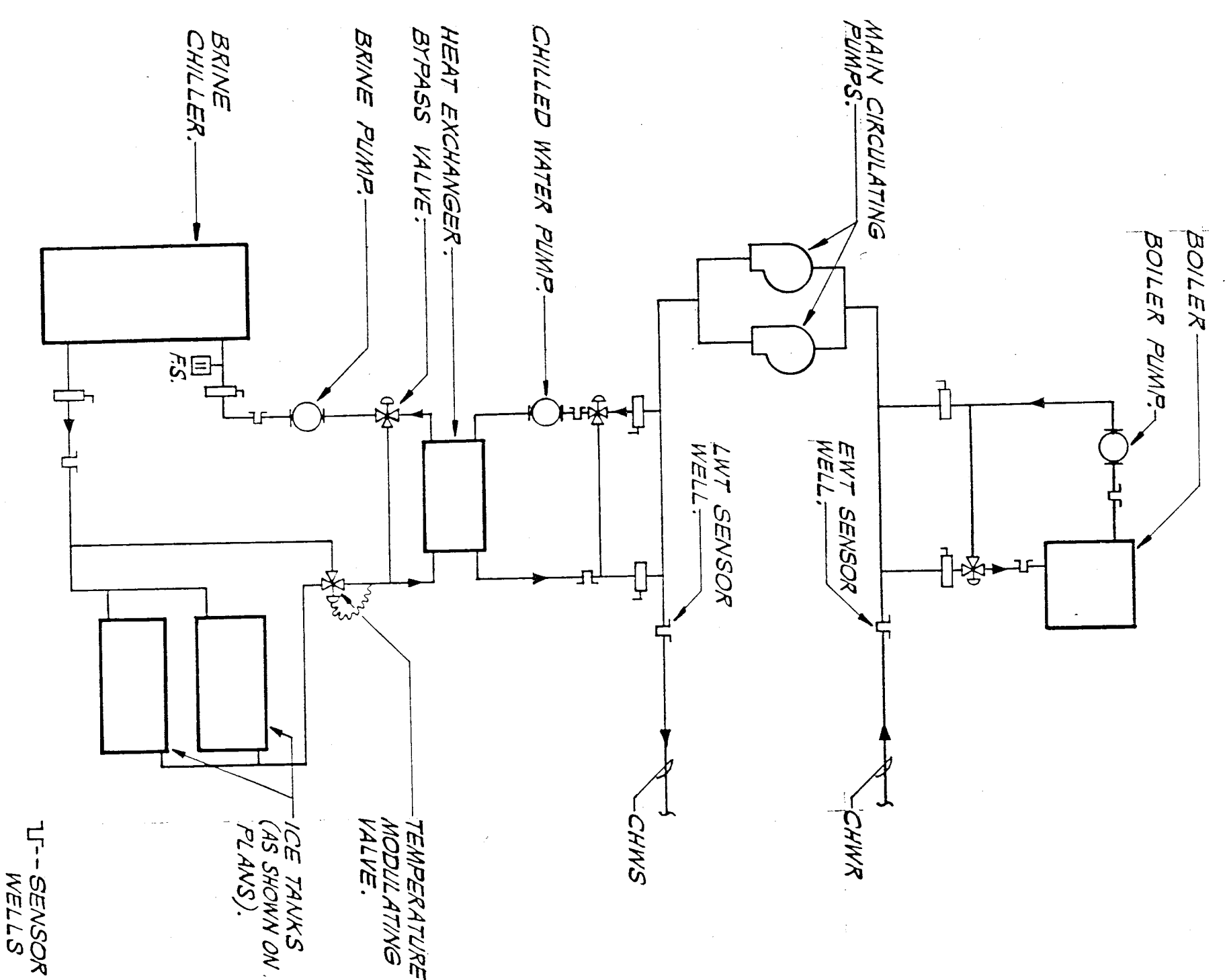

**CENTRAL PLANT PIPING SCHEMATIC**  
SCALE: NONE

L  
MP-5

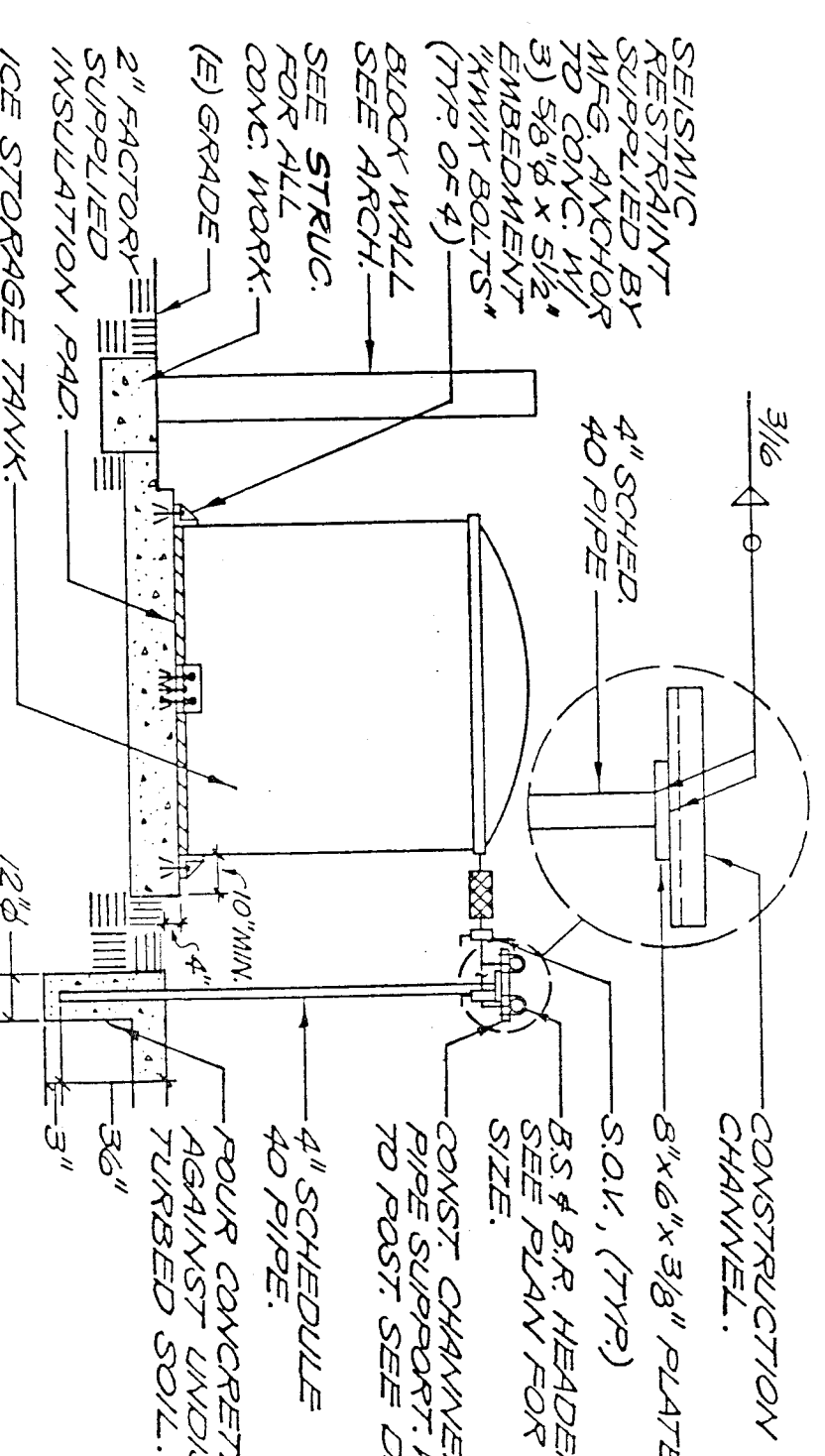

**ICE STORAGE TANK DETAIL**  
SCALE: NONE

G  
MP-5

**UNIT VENTILATOR CONTROL**  
SCALE: NONE

F  
MP-5

**FLUE THRU ROOF DETAIL**  
SCALE: NONE

B  
MP-5

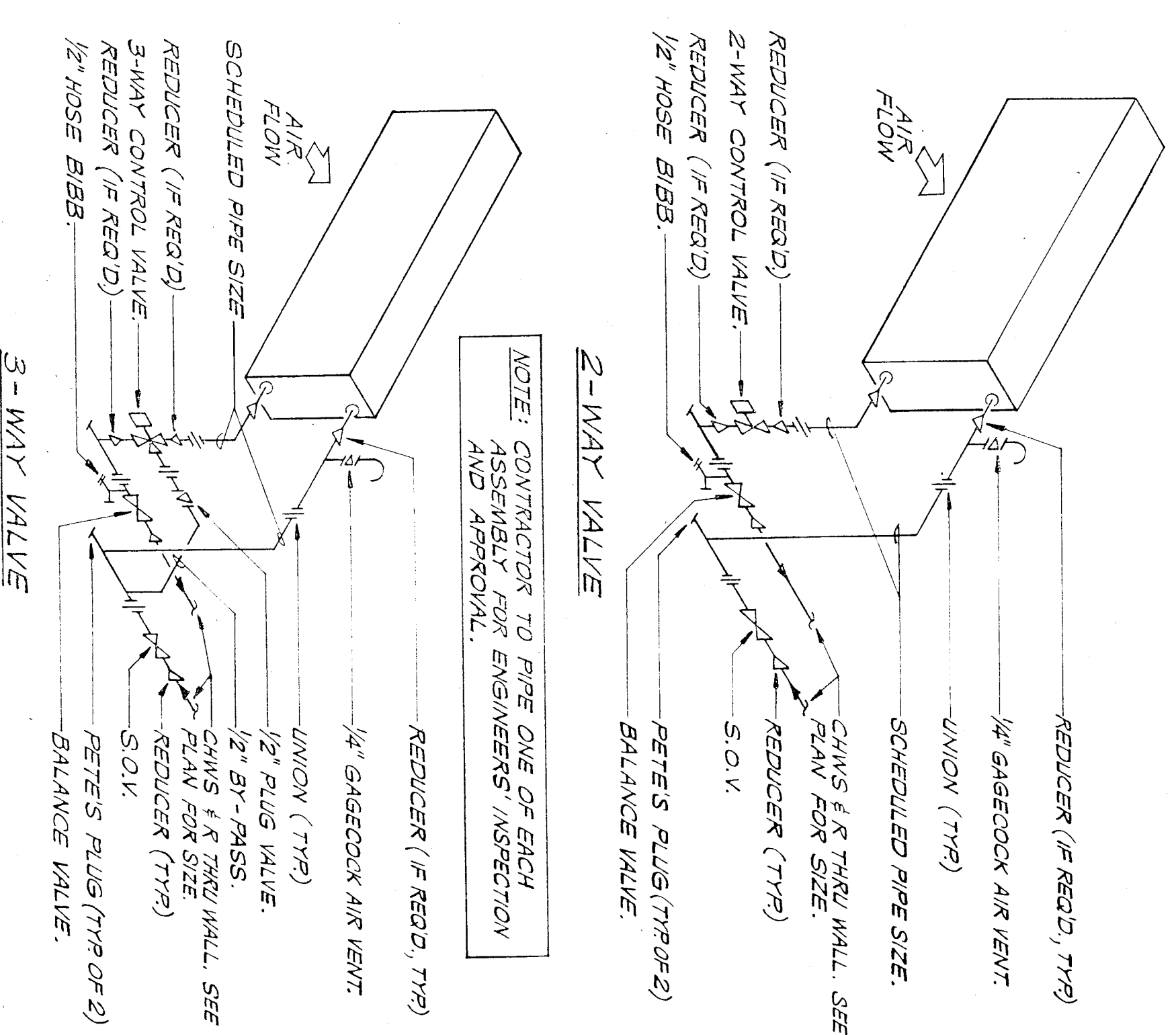

**UNIT VENTILATOR PIPING DETAIL**  
SCALE: NONE

D  
MP-5

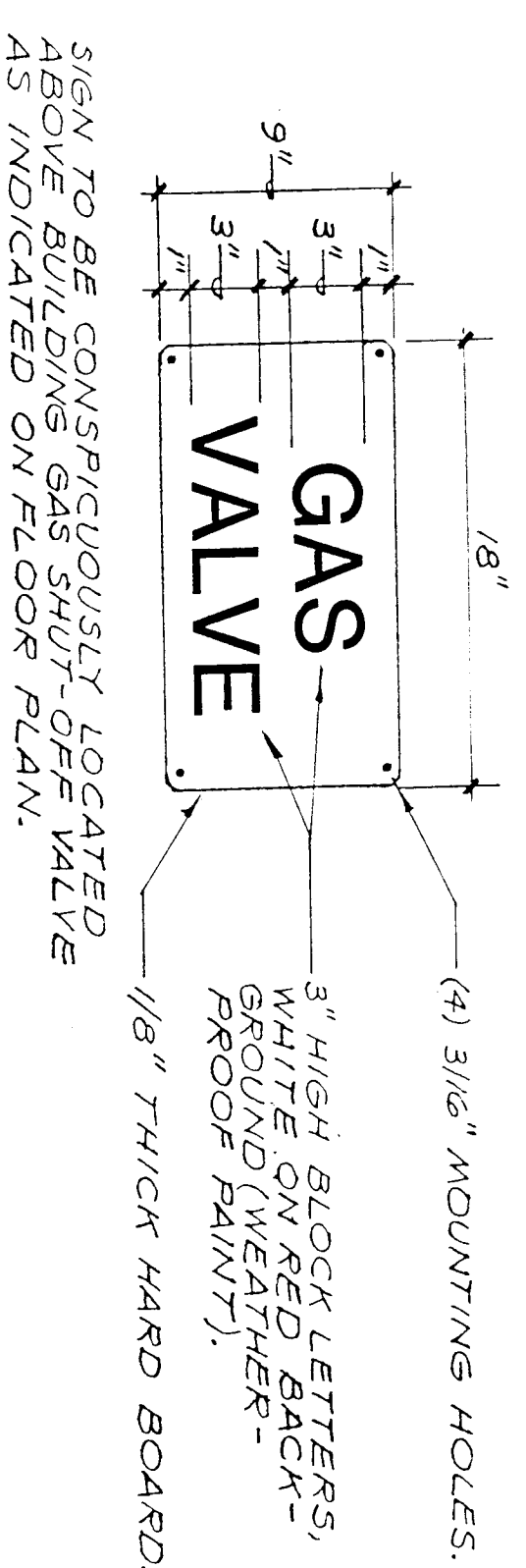

**GAS VALVE SIGN DETAIL**  
SCALE: NONE

M  
MP-5

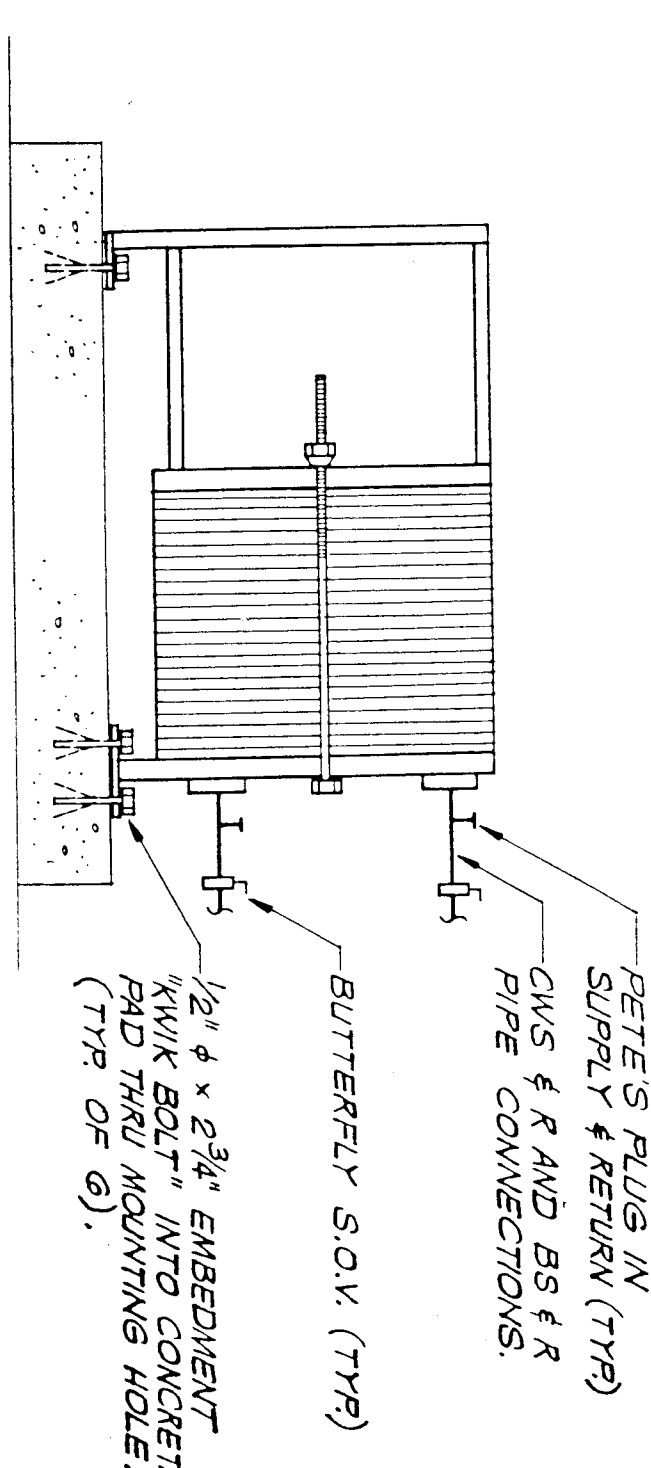

**HEAT EXCHANGER MOUNTING DETAIL**  
SCALE: NONE

H  
MP-5

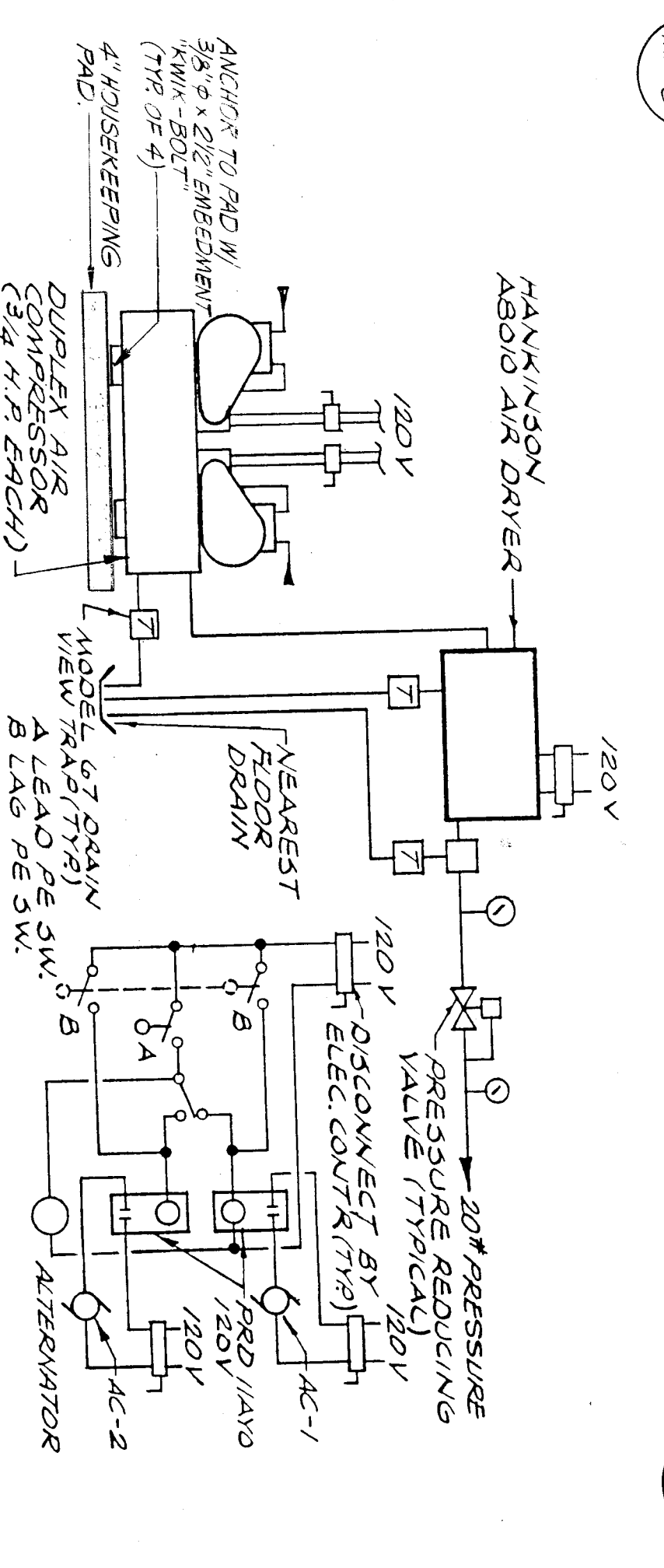

**CONTROL AIR COMPRESSOR**  
SCALE: NONE

C  
MP-5

