

**INTELLECTUAL PROPERTY & PROPRIETARY RIGHTS STATEMENT**  
COPYRIGHT © AMERICAN MODULAR SYSTEMS (AMS)  
AMS OWNS ALL COPYRIGHT AND OTHER INTELLECTUAL PROPERTY AND PROPRIETARY RIGHTS IN THESE DRAWINGS, SPECIFICATIONS AND THE MATERIAL CONTAINED HEREIN. CERTAIN ELEMENTS SHOWN IN THESE DOCUMENTS ARE REGISTERED TRADEMARKS OF AMS. ALL INVENTIBLE MATERIALS CONTAINED IN THESE DOCUMENTS AND OPERATING WITH AMS WILL REMAIN THE SOLE PROPERTY OF AMS. THESE DRAWINGS, SPECIFICATIONS, AND THE MATERIAL CONTAINED HEREIN MAY NOT BE REPRODUCED, TRANSMITTED, COPIED, DISTRIBUTED, MOVED, OR OTHERWISE DISPOSED OF (DIRECTLY OR INDIRECTLY) AND MAY NOT BE USED IN WHOLE OR IN PART TO ASSIST IN THE CONSTRUCTION, DESIGN, OR OTHER WORK OF, OR FOR THE PURPOSE OF FURNISHING ANY INFORMATION FOR THE CONSTRUCTION, DESIGN, OR OTHER WORK OF, ANY BUILDING, APARTMENT, OR TRACT THEREOF, EXCEPT AS EXPRESSLY PERMITTED BY WRITTEN CONSENT OR IN A WRITTEN AGREEMENT WITH AMS. SUBMITTAL OR DISTRIBUTION TO MEET OFFICIAL REGULATORY REQUIREMENTS WILL NOT BE CONSIDERED AS INFRINGEMENT OR DEROGATION OF AMS'S COPYRIGHT OR OTHER INTELLECTUAL PROPERTY OR PROPRIETARY RIGHTS.

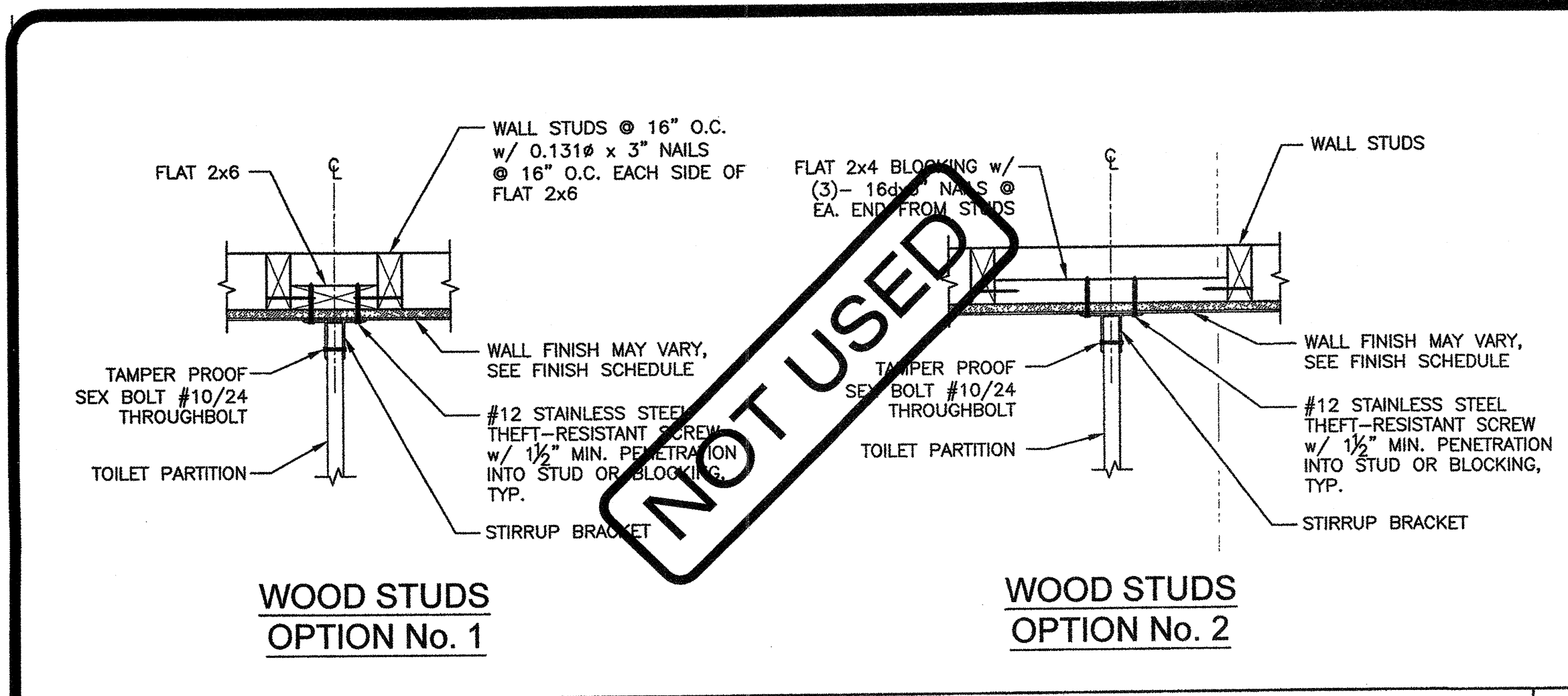

NOTCH & BORING SCHEDULE					
SIZE	NOMINAL	ACTUAL	NOTCHING	BORING	MAX. BORE
2x4	4"	3 1/2"	7/8"	1"	2 1/8"
2x6	6"	5 1/2"	1 1/8"	1 3/8"	3 1/4"
2x8	8"	7 1/4"	1 13/16"	2 1/8"	4 3/8"

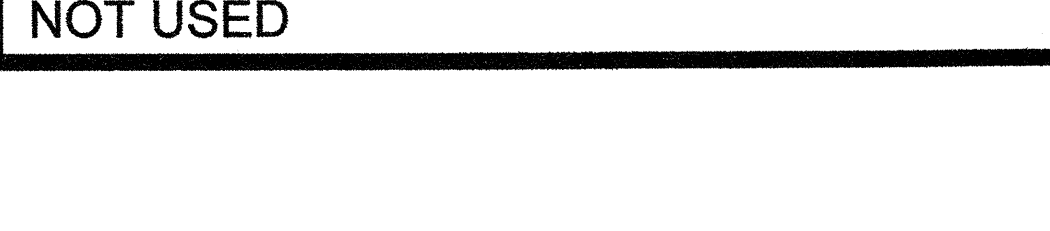
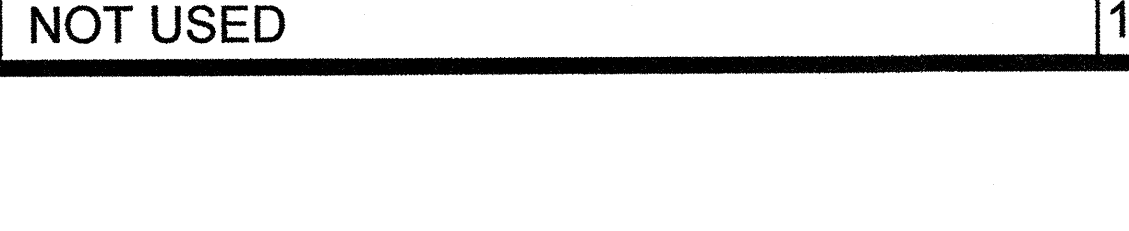
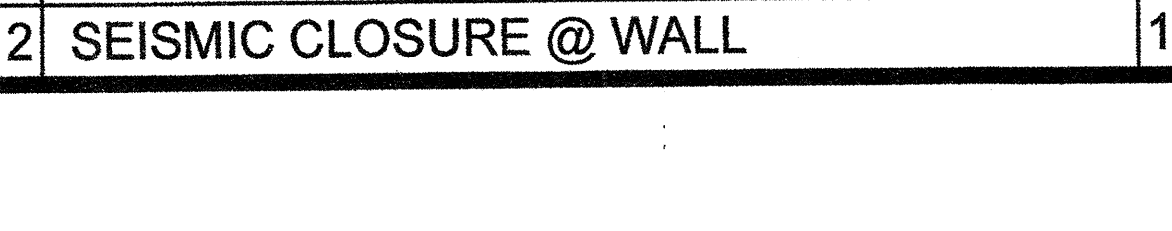
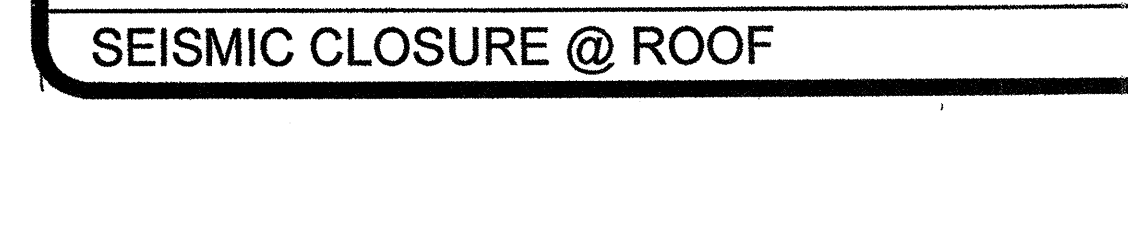
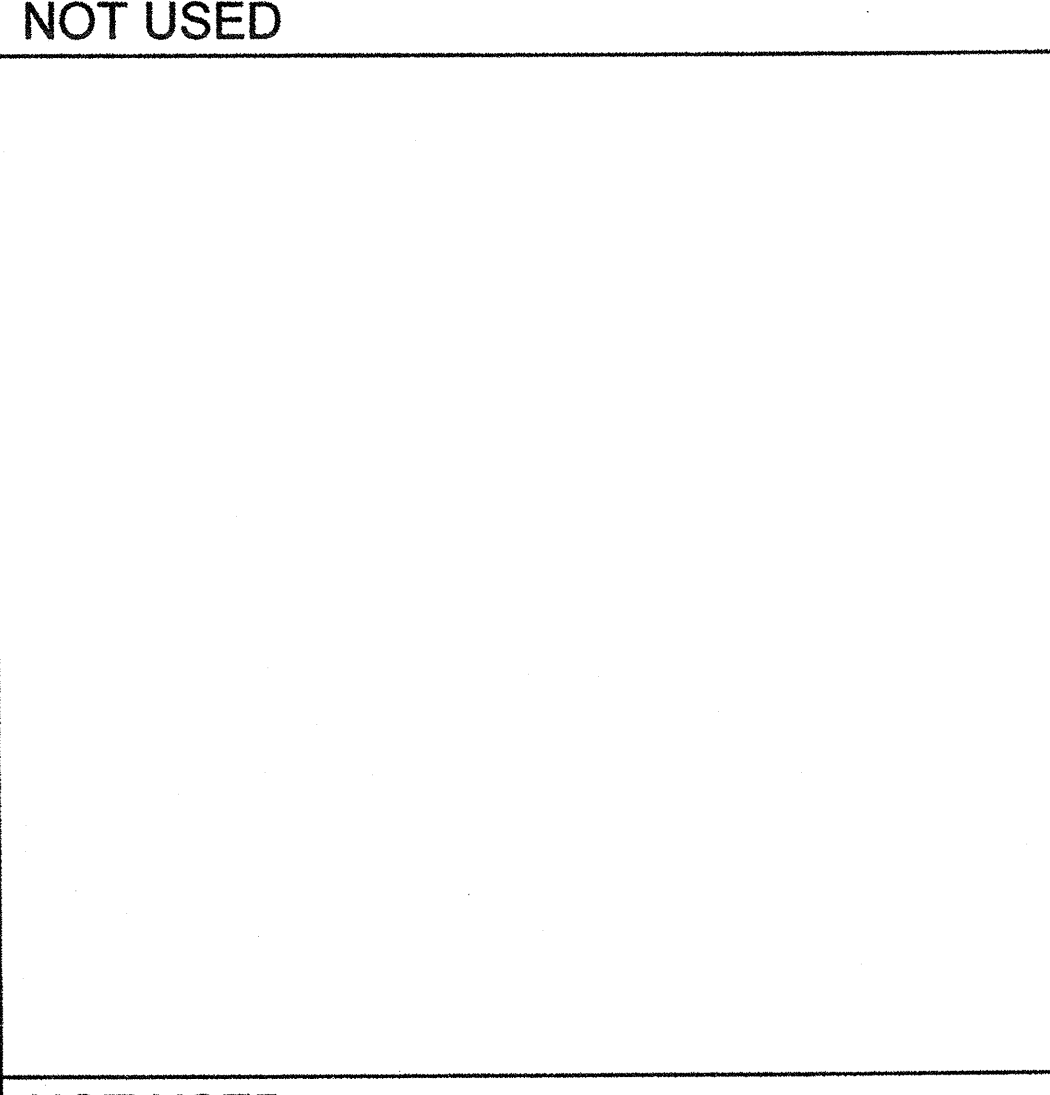
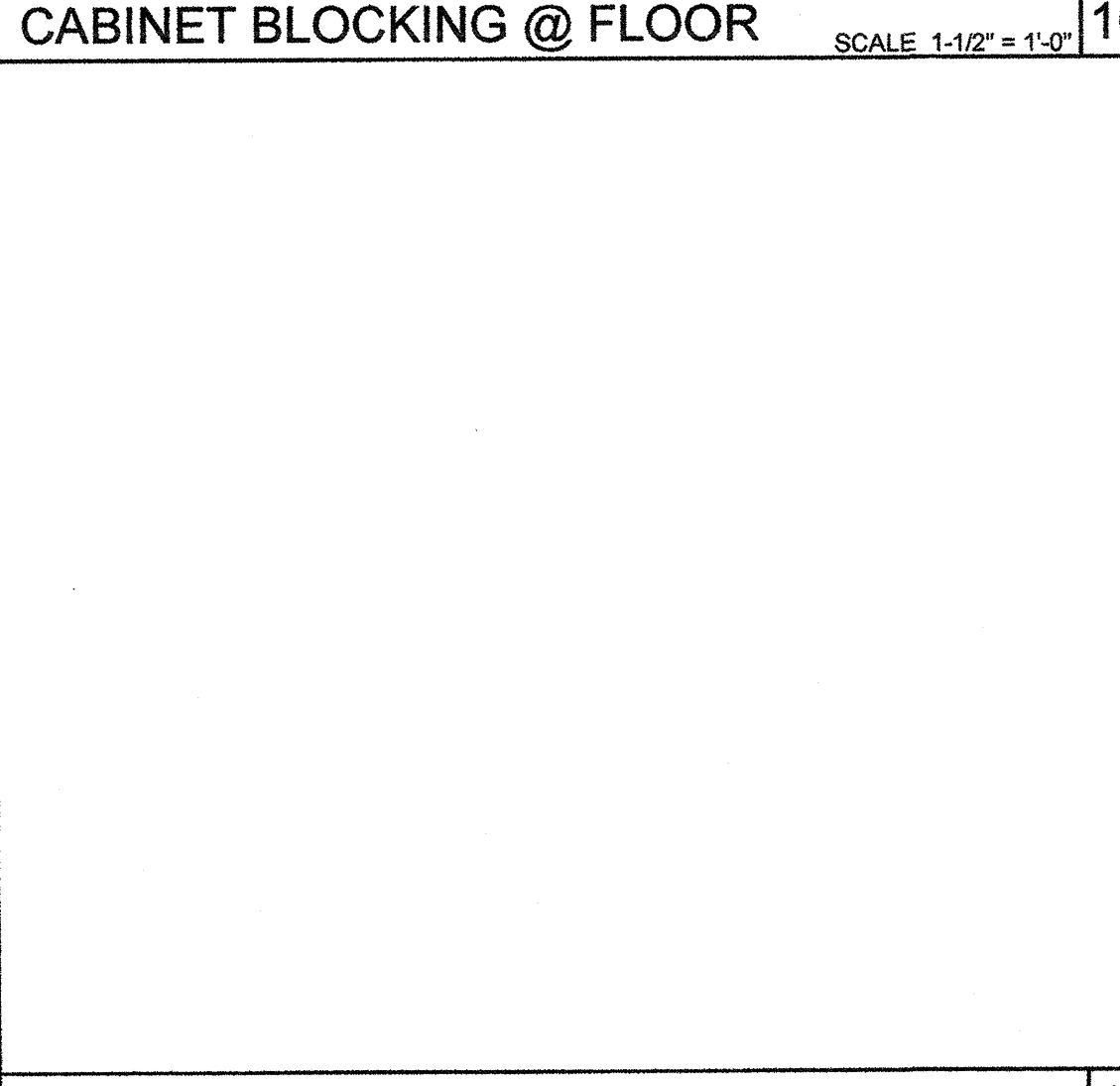
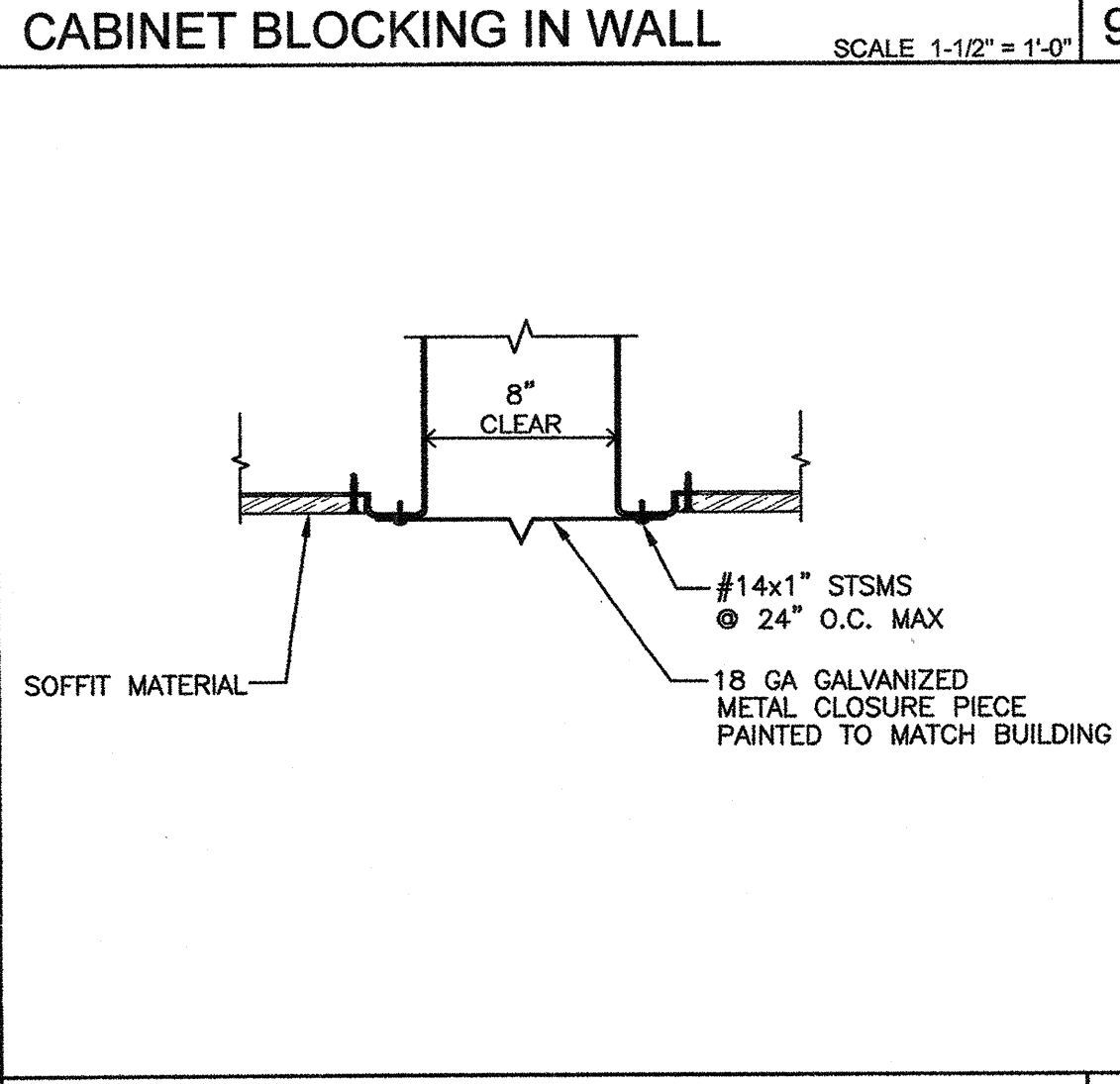
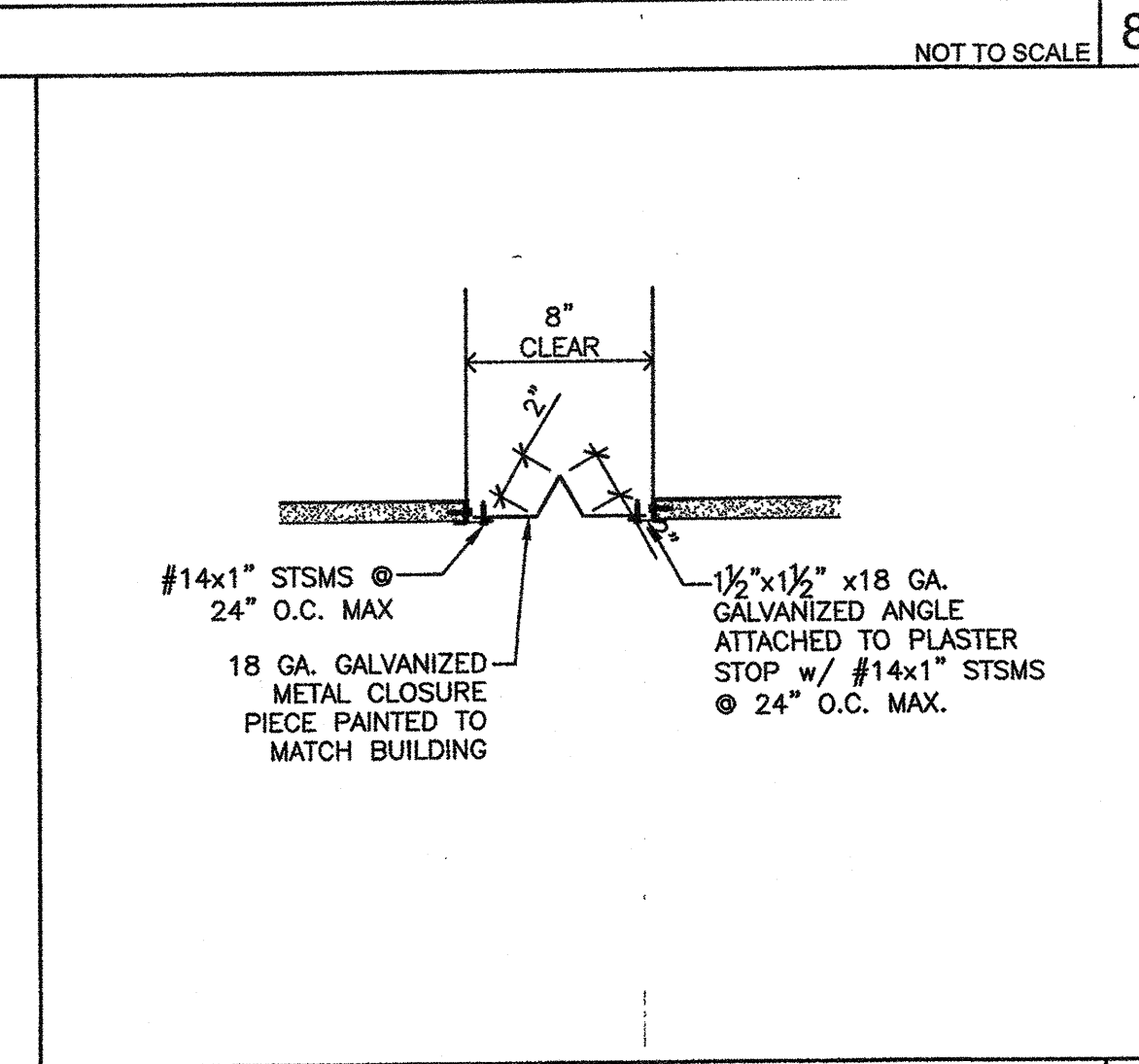
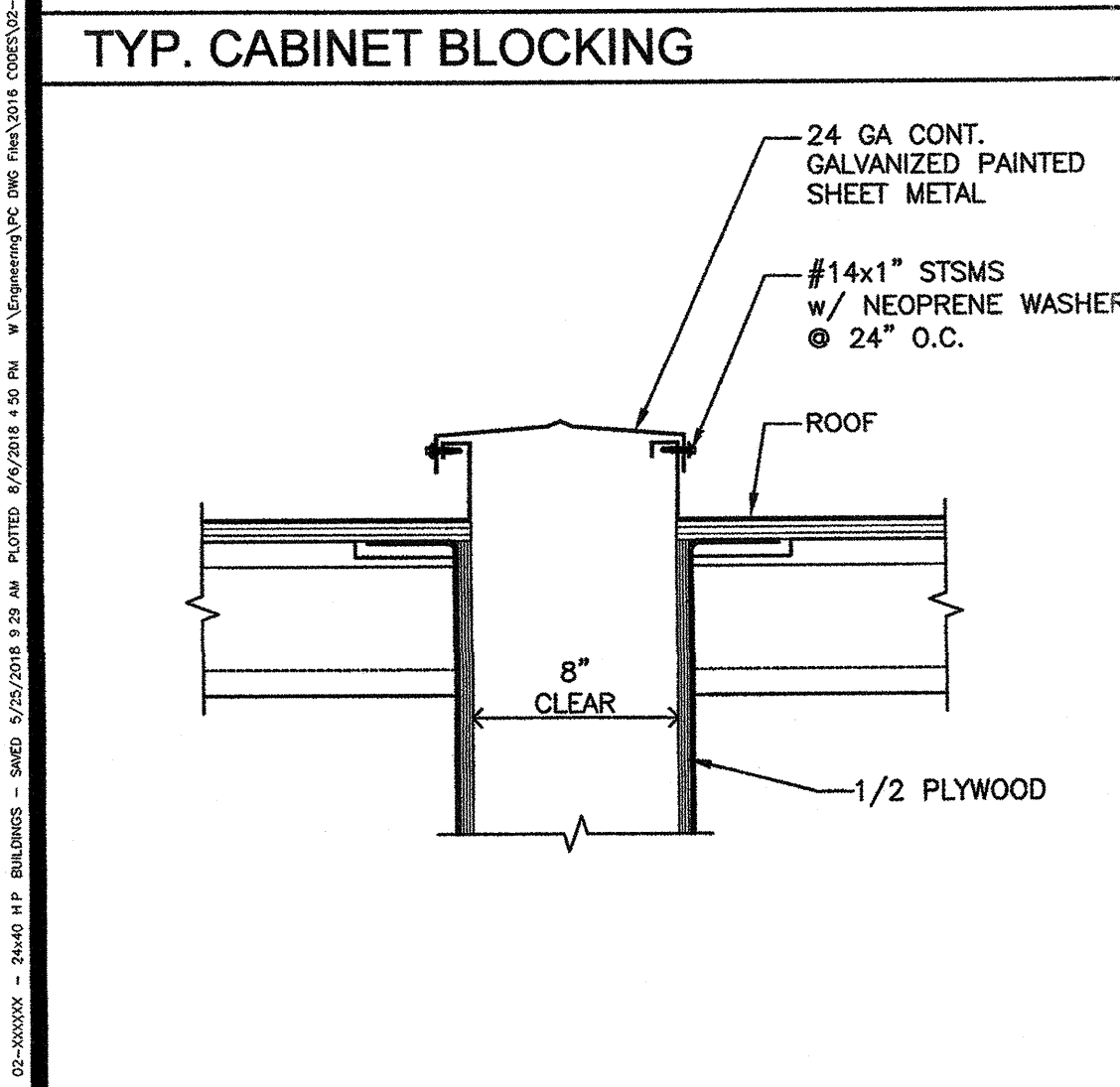
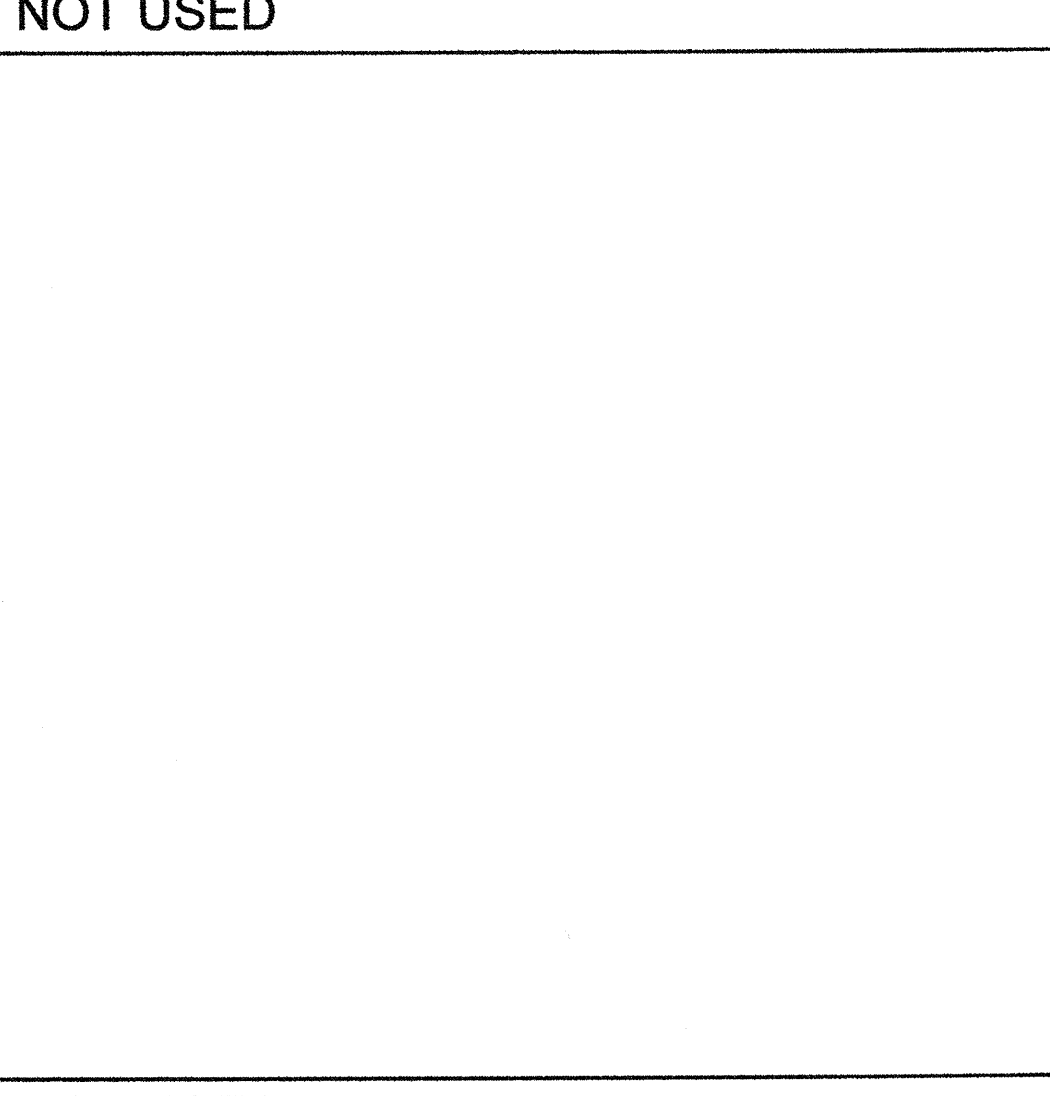
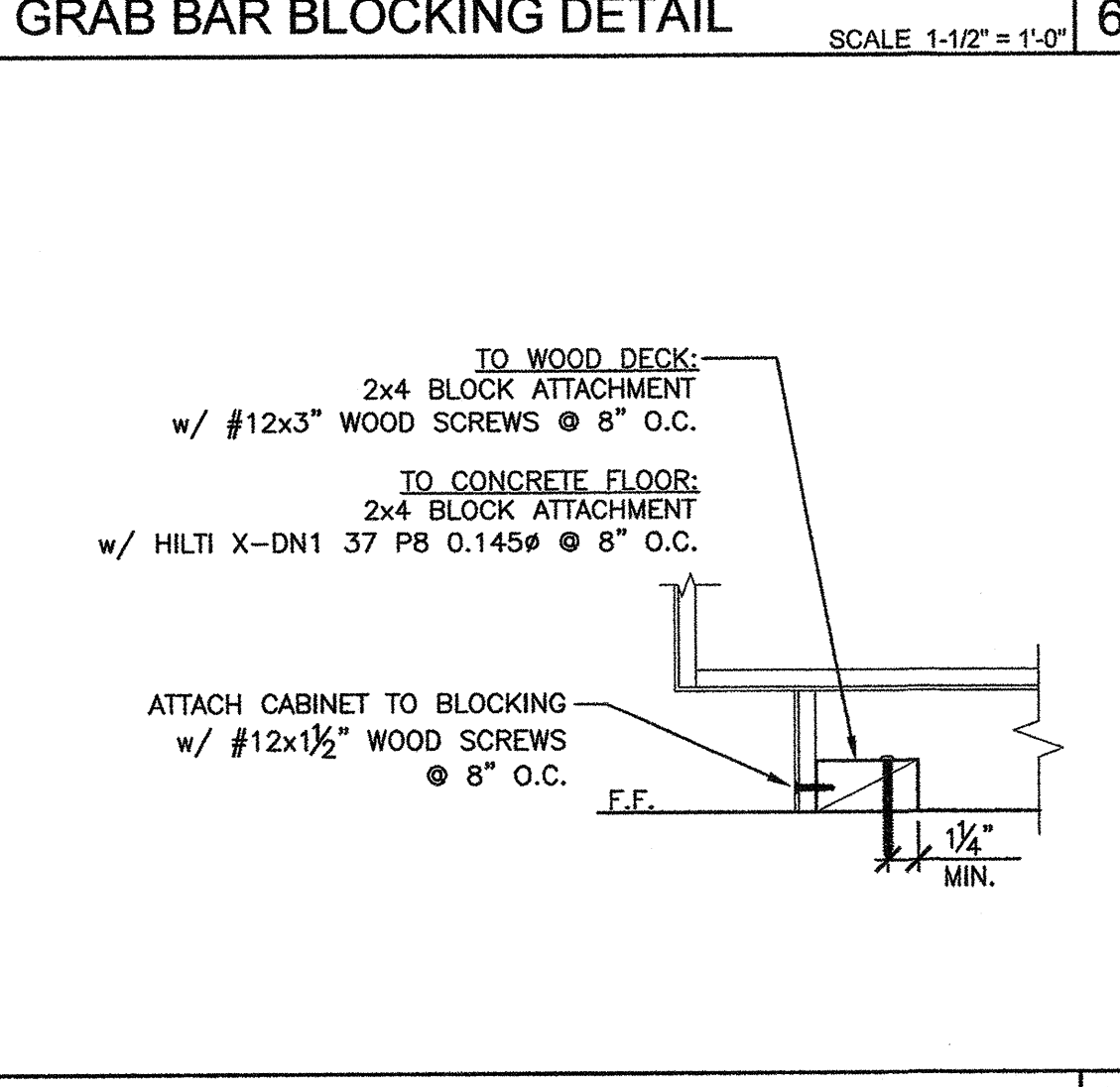
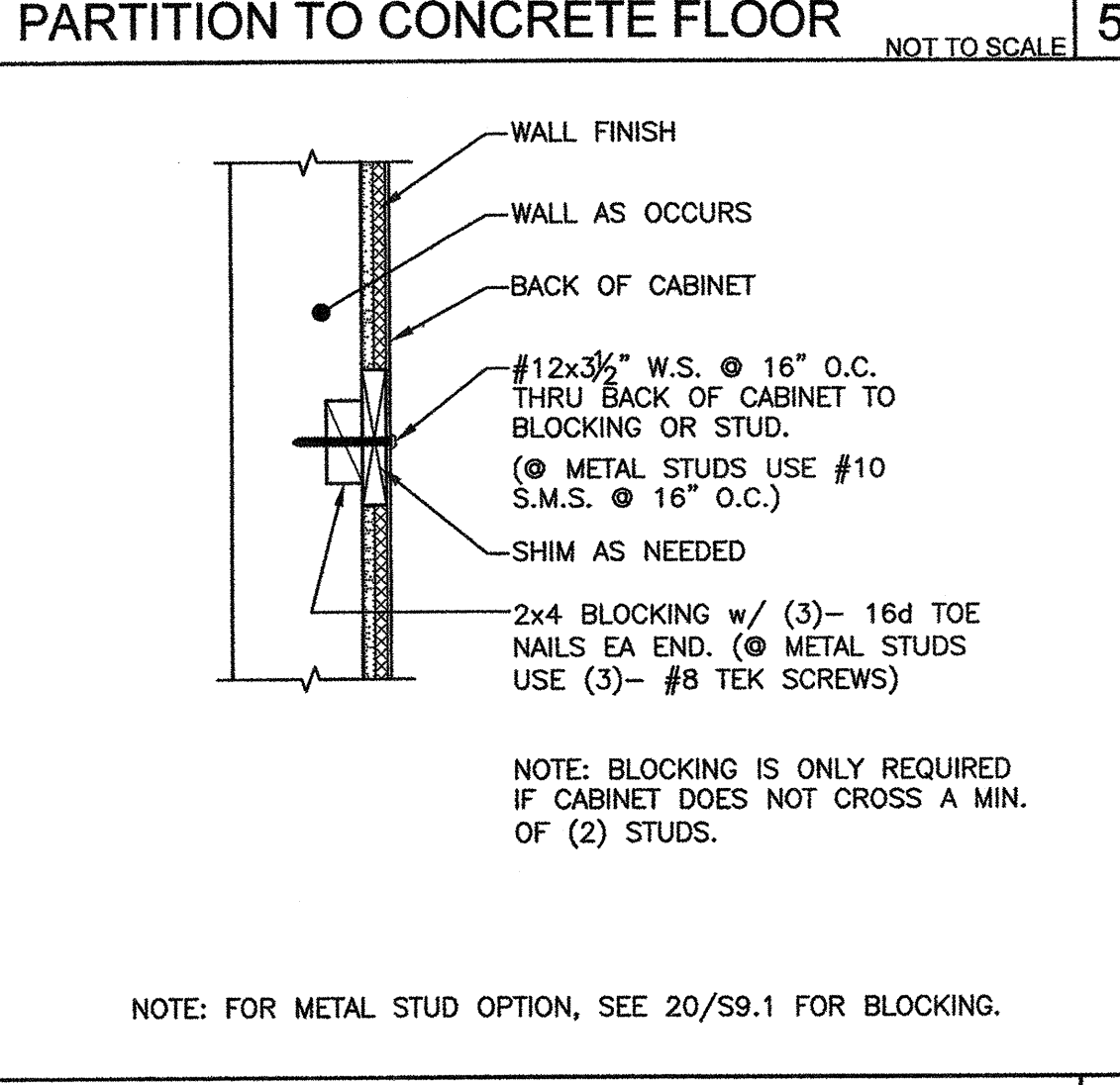
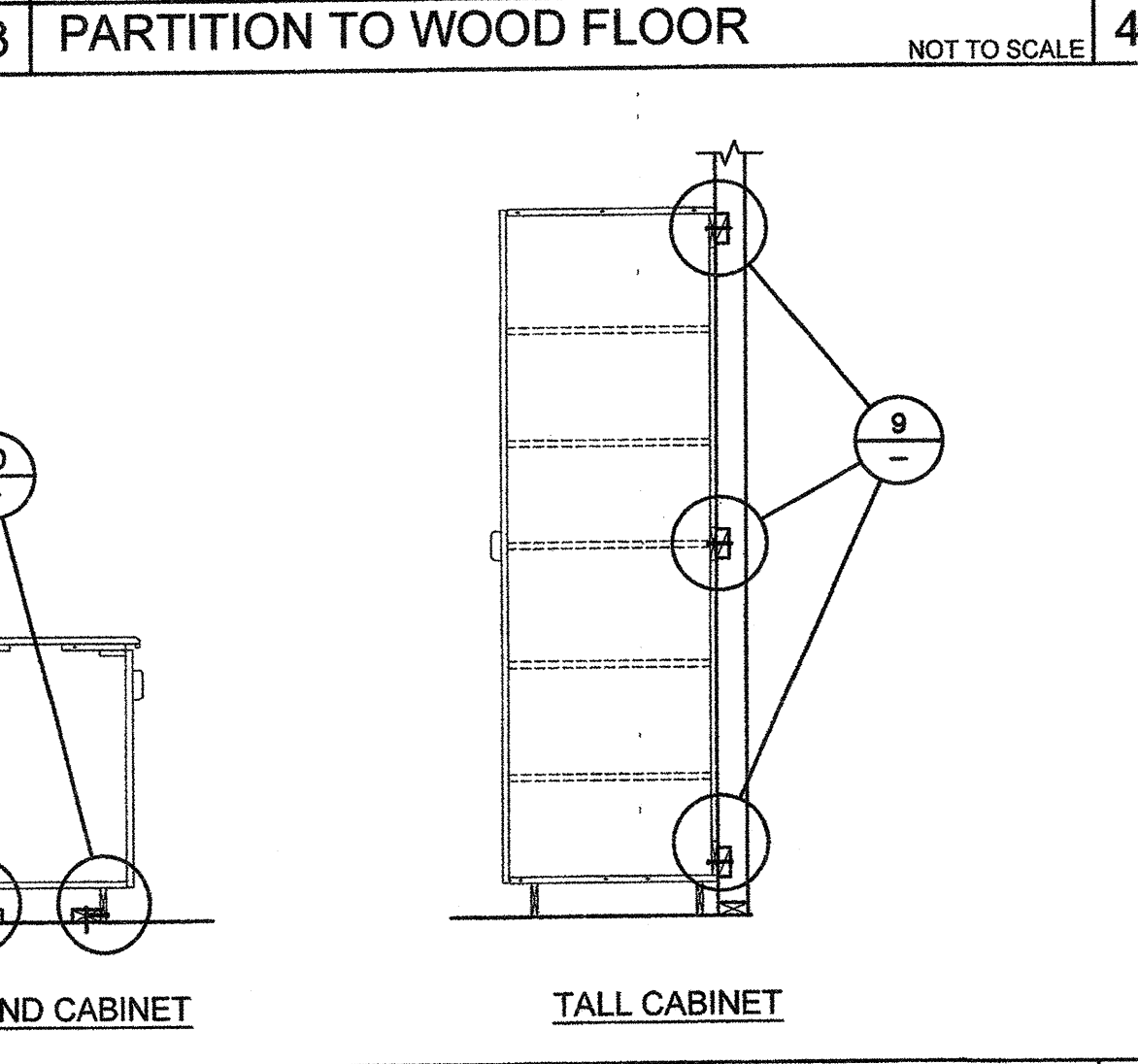
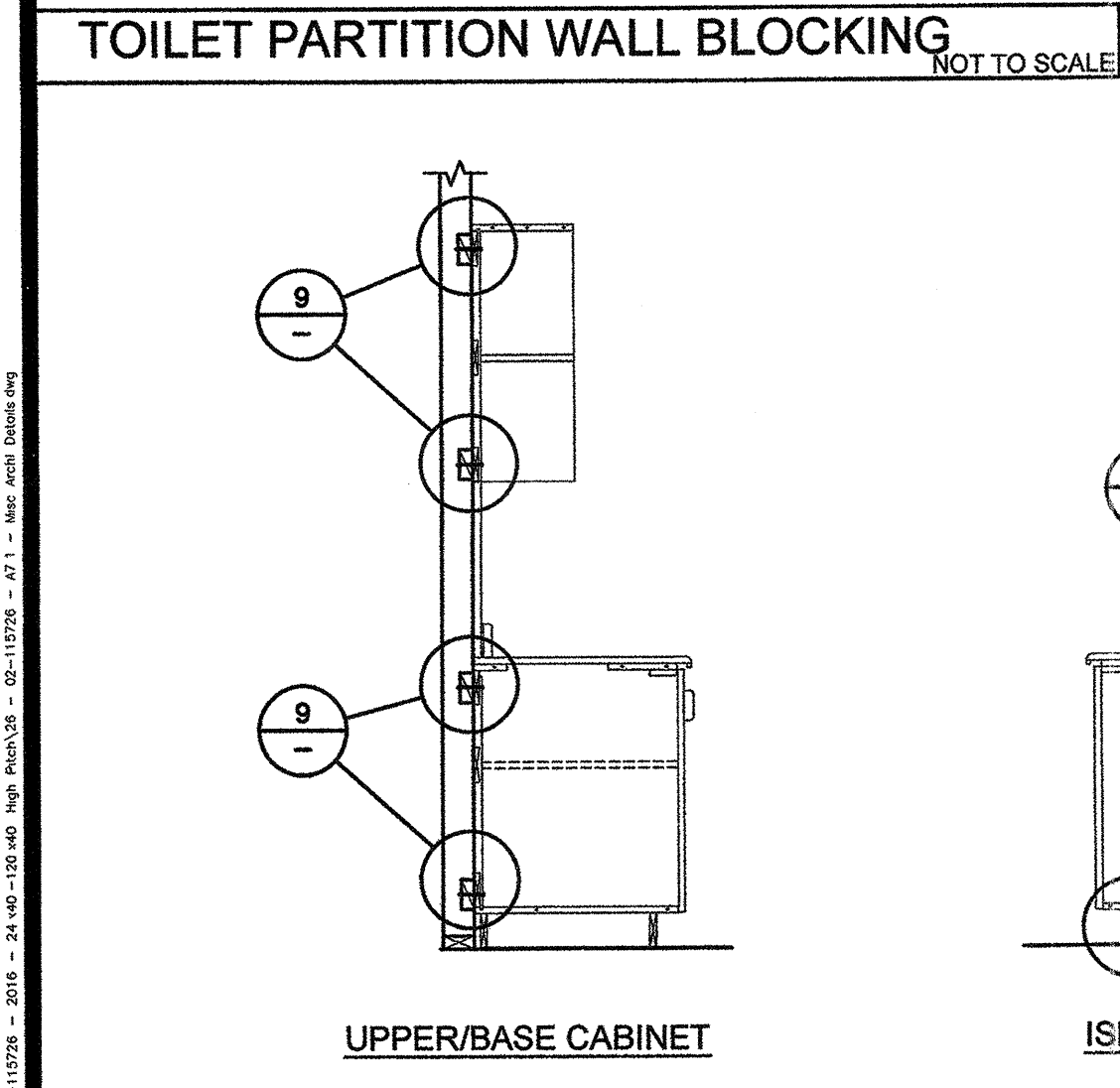
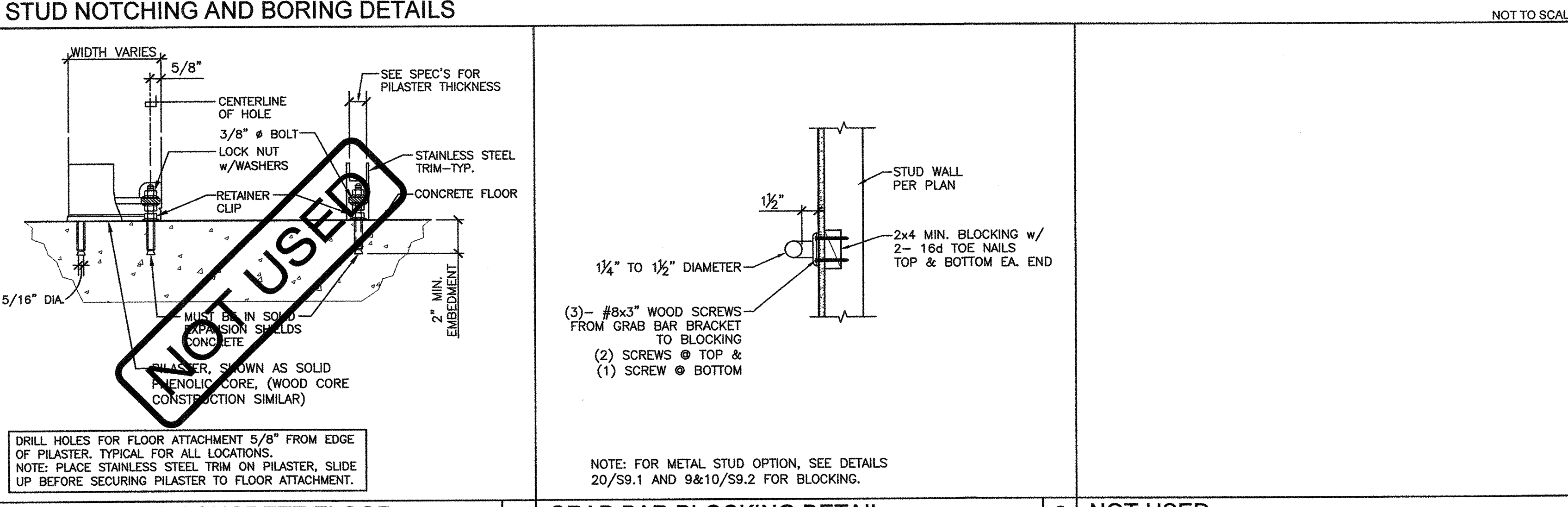
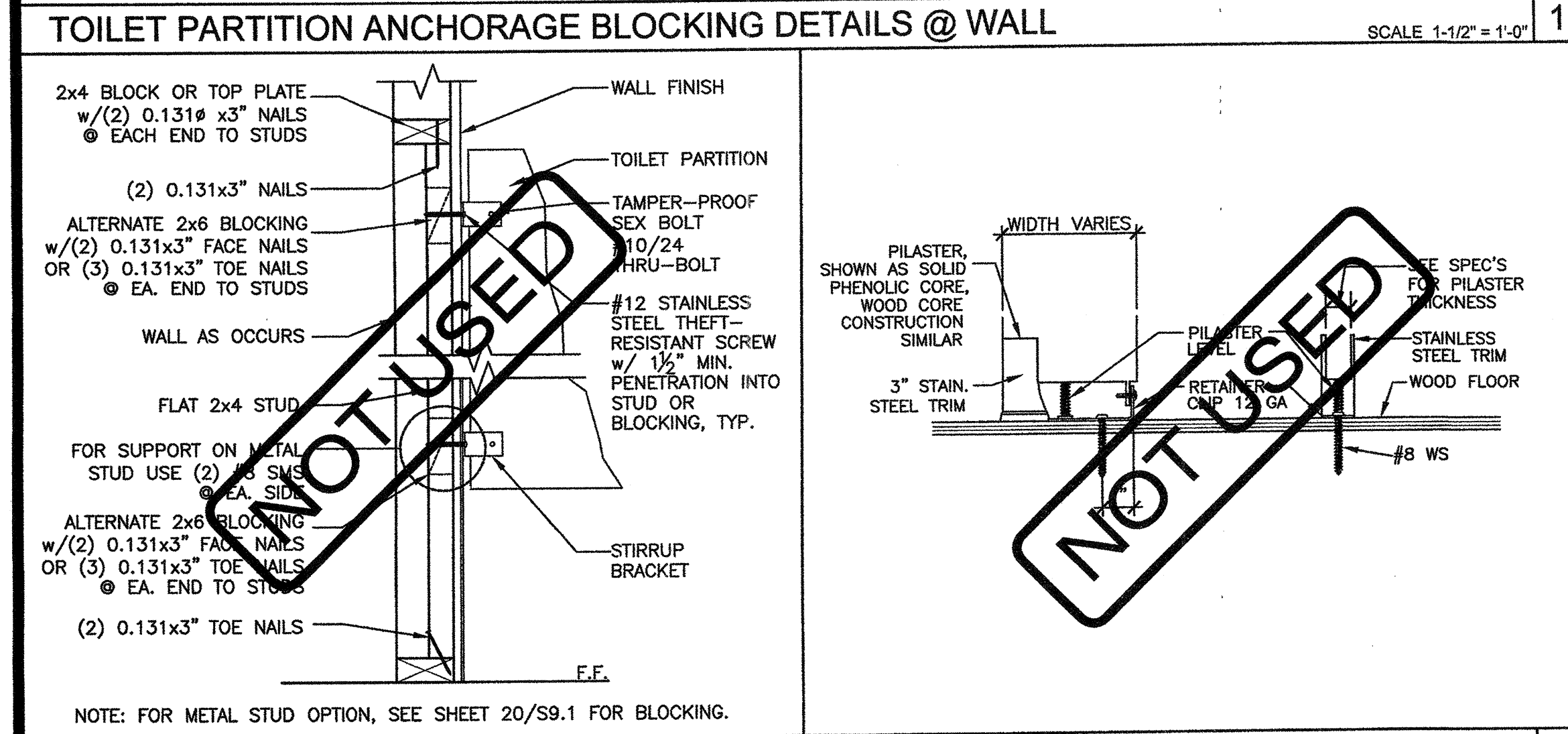
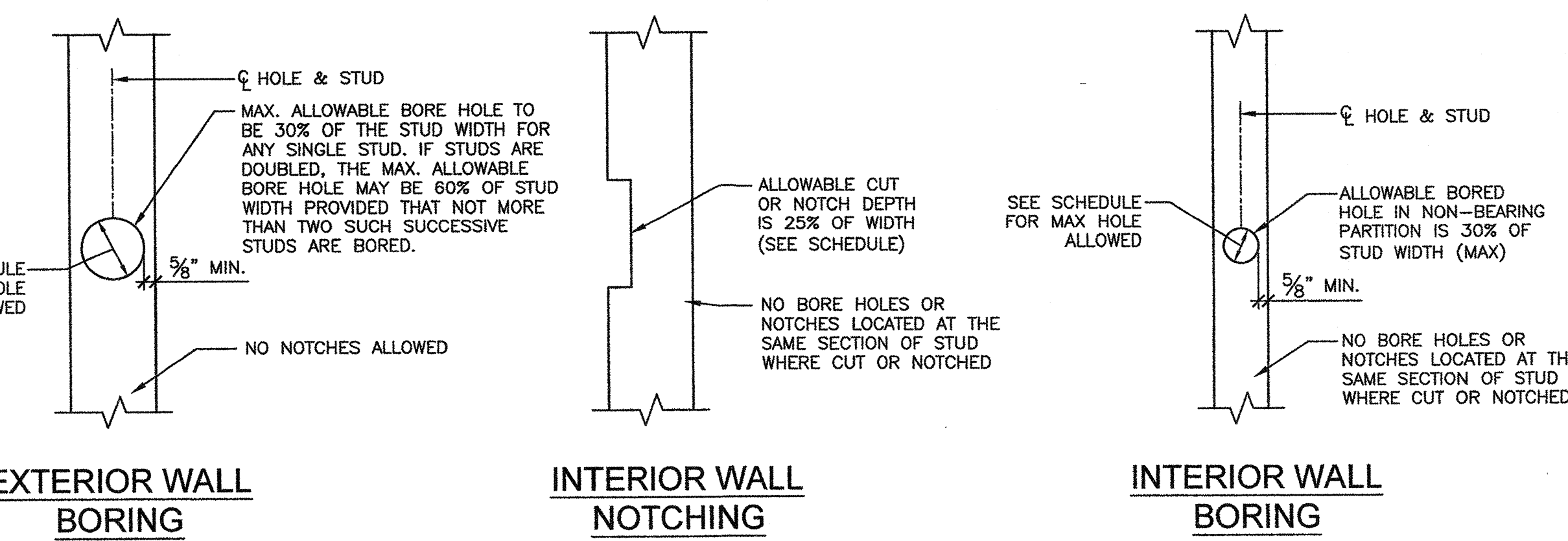

PRE-CHECKED SET NAME  
**24'x40' THRU 120'x40' HIGH PITCH MODULAR BUILDINGS**

SITE SPECIFIC PROJECT NAME

SHEET TITLE  
**MISCELLANEOUS ARCHITECTURAL DETAILS**

MANUFACTURER PROFESSIONAL OF RECORD ON PC

THESE DRAWINGS ARE PRELIMINARY AND NOT FOR CONSTRUCTION UNLESS SHOWN & SIGNED BY THE ENGINEER OF RECORD

PROJECT SPECIFIC STATE AGENCY APPROVAL

ORIGINAL PC STATE AGENCY APPROVAL

PRE-CHECK (PC) DOCUMENT  
CODE 2018 CBC  
A SEPARATE PROJECT APPLICATION FOR CONSTRUCTION IS REQUIRED.

REVISIONS  
DRAWN BY: AS NOTED  
SCALE: AS NOTED  
DATE: SHEET NUMBER

**A7.1-02**